

Engine Control <3UZ-FE>

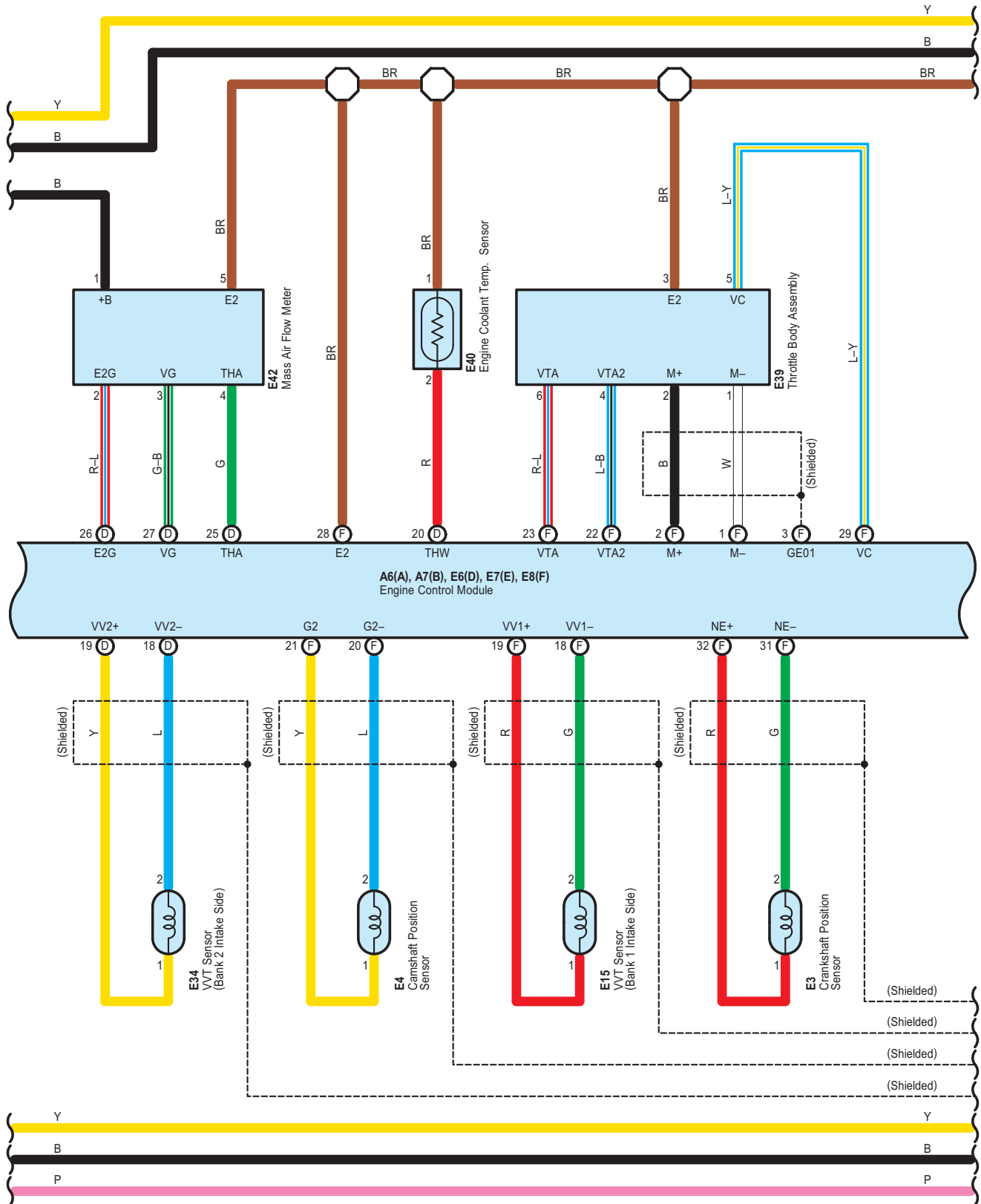

Engine Control <3UZ-FE>

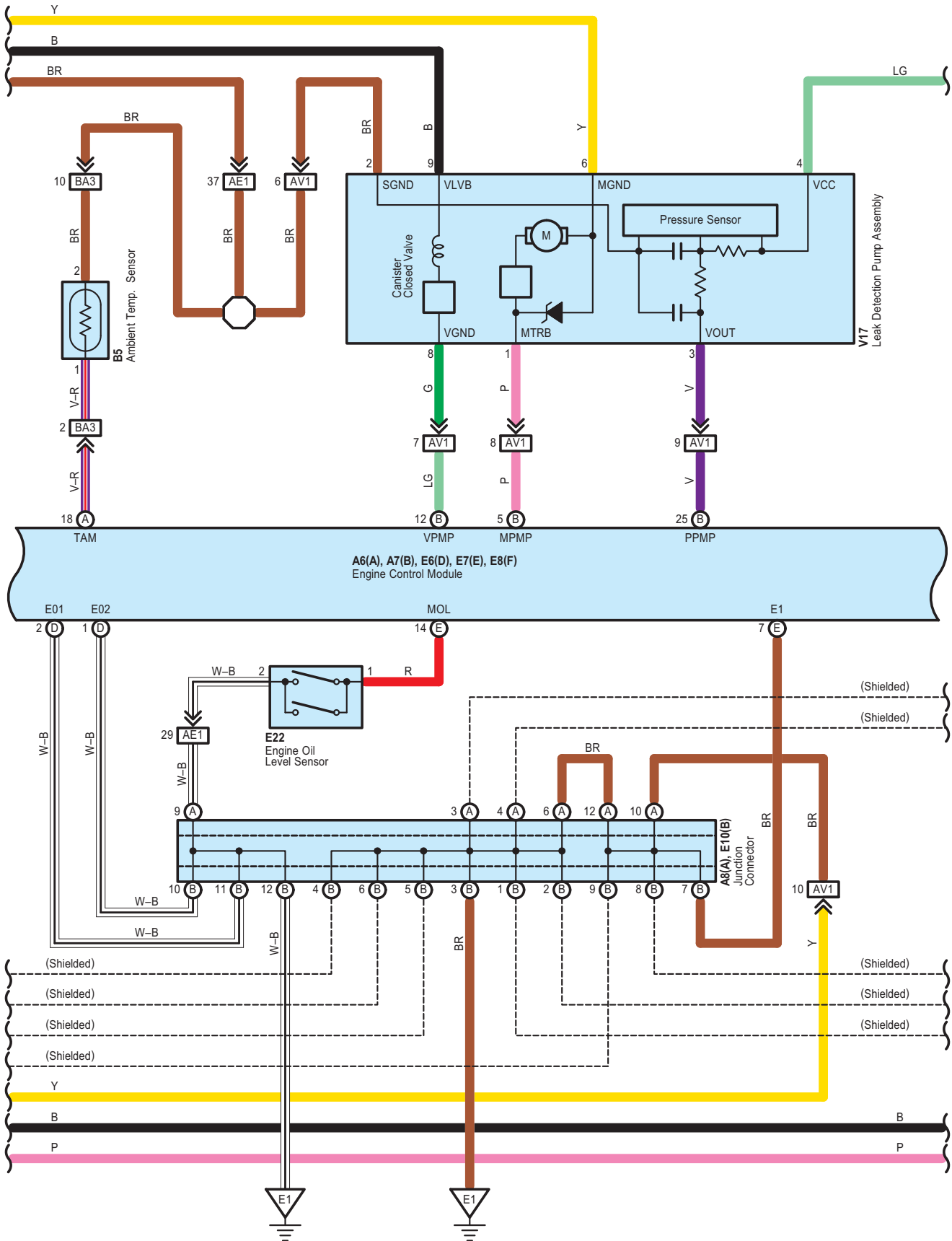

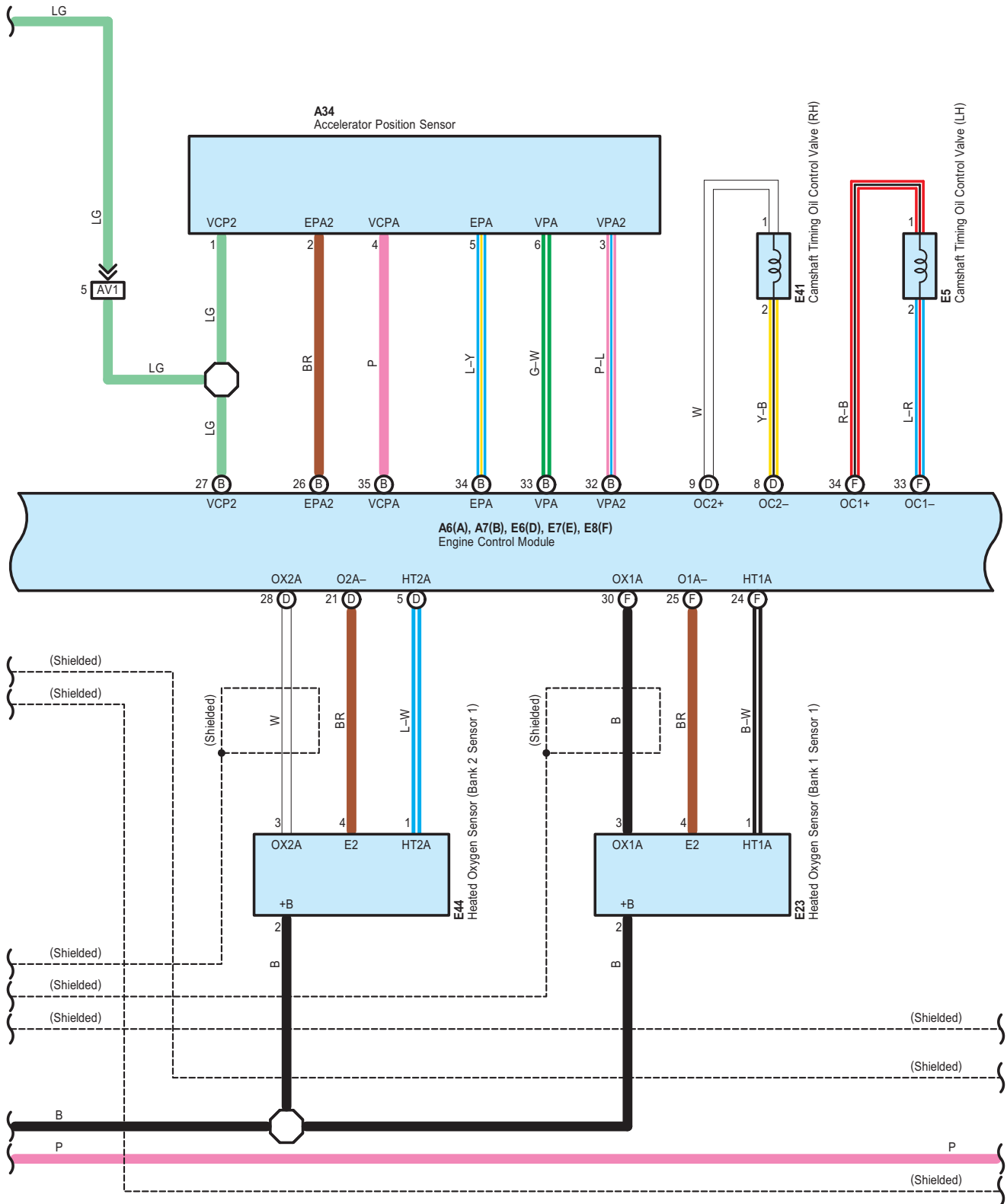

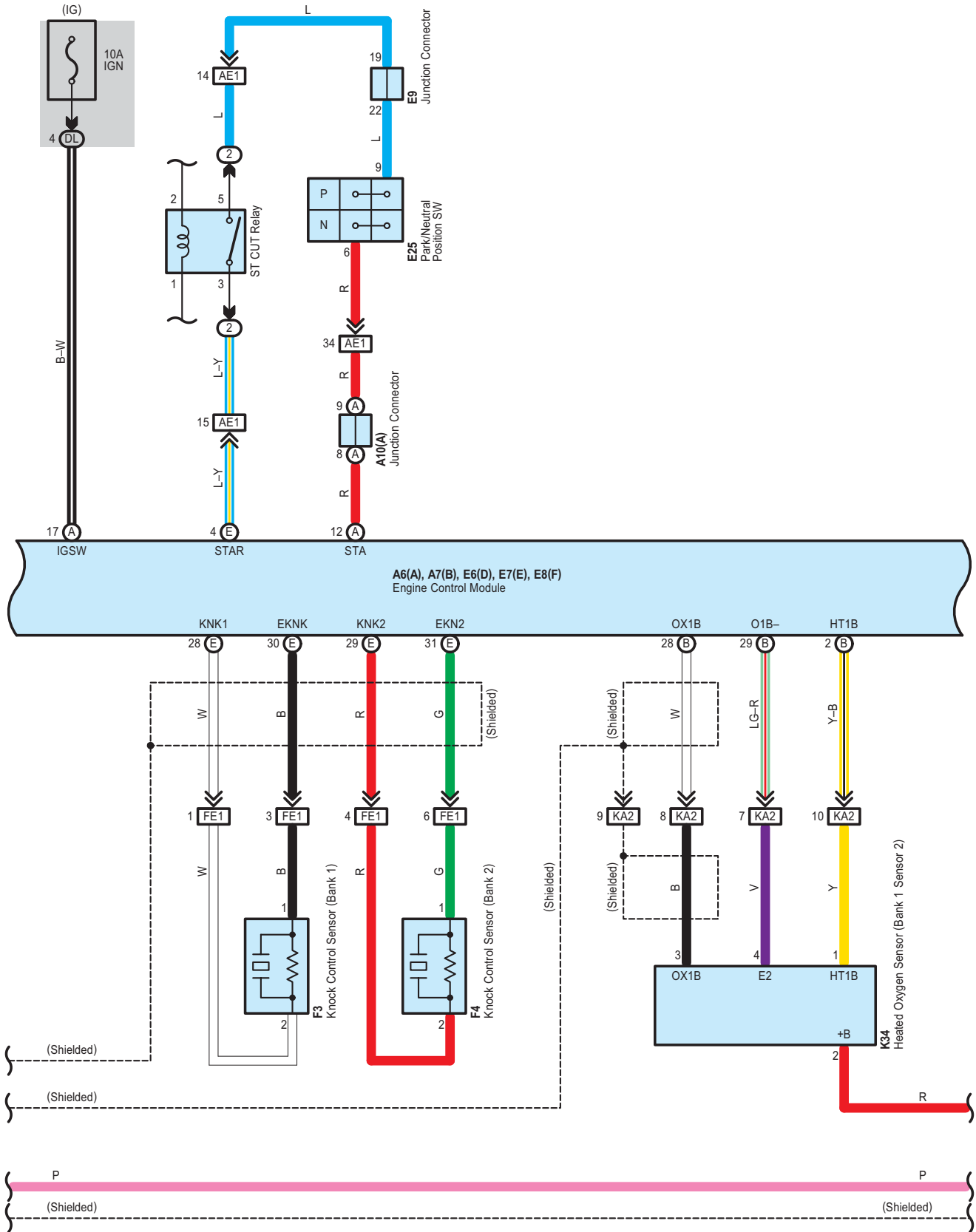

Engine Control <3UZ-FE>

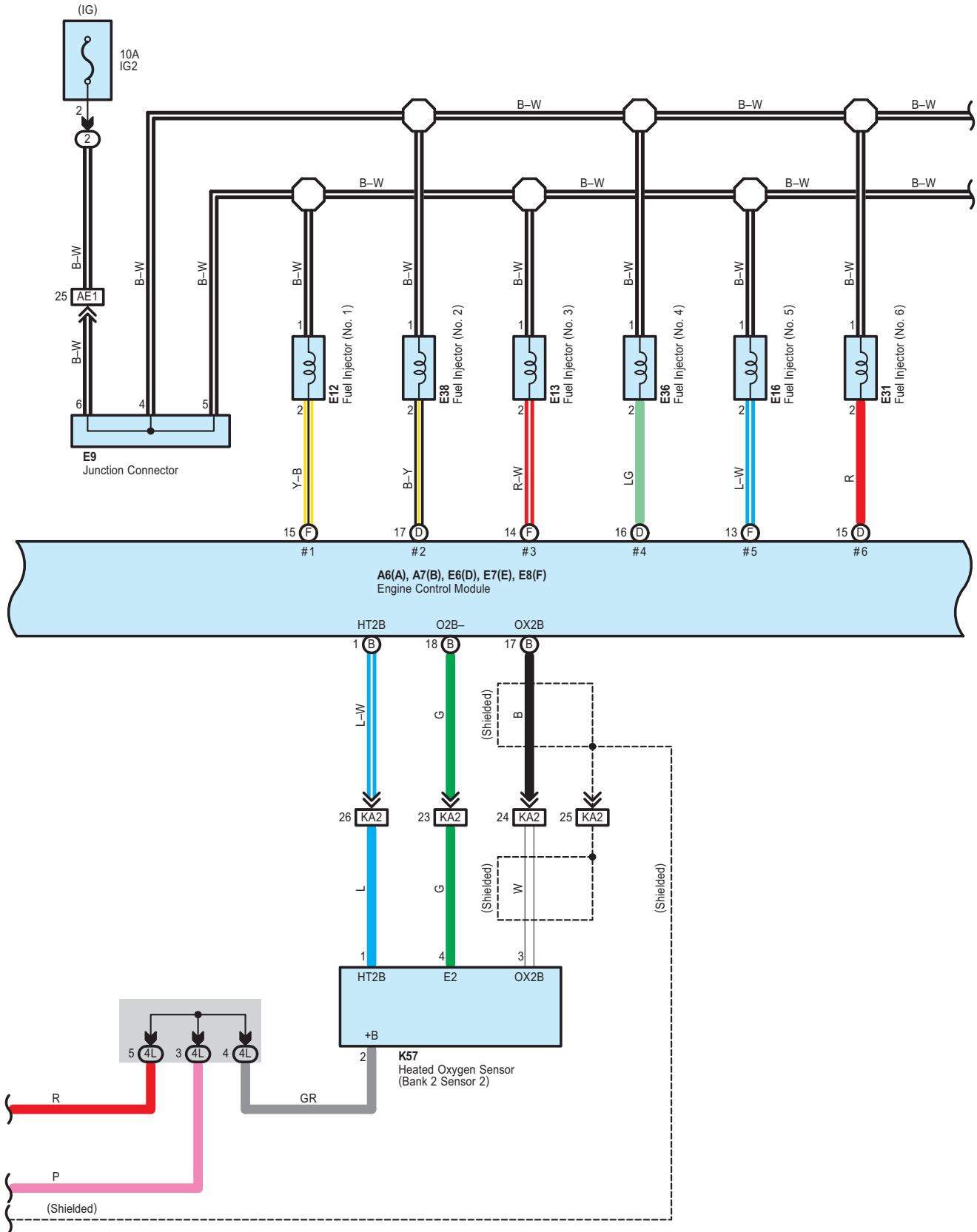

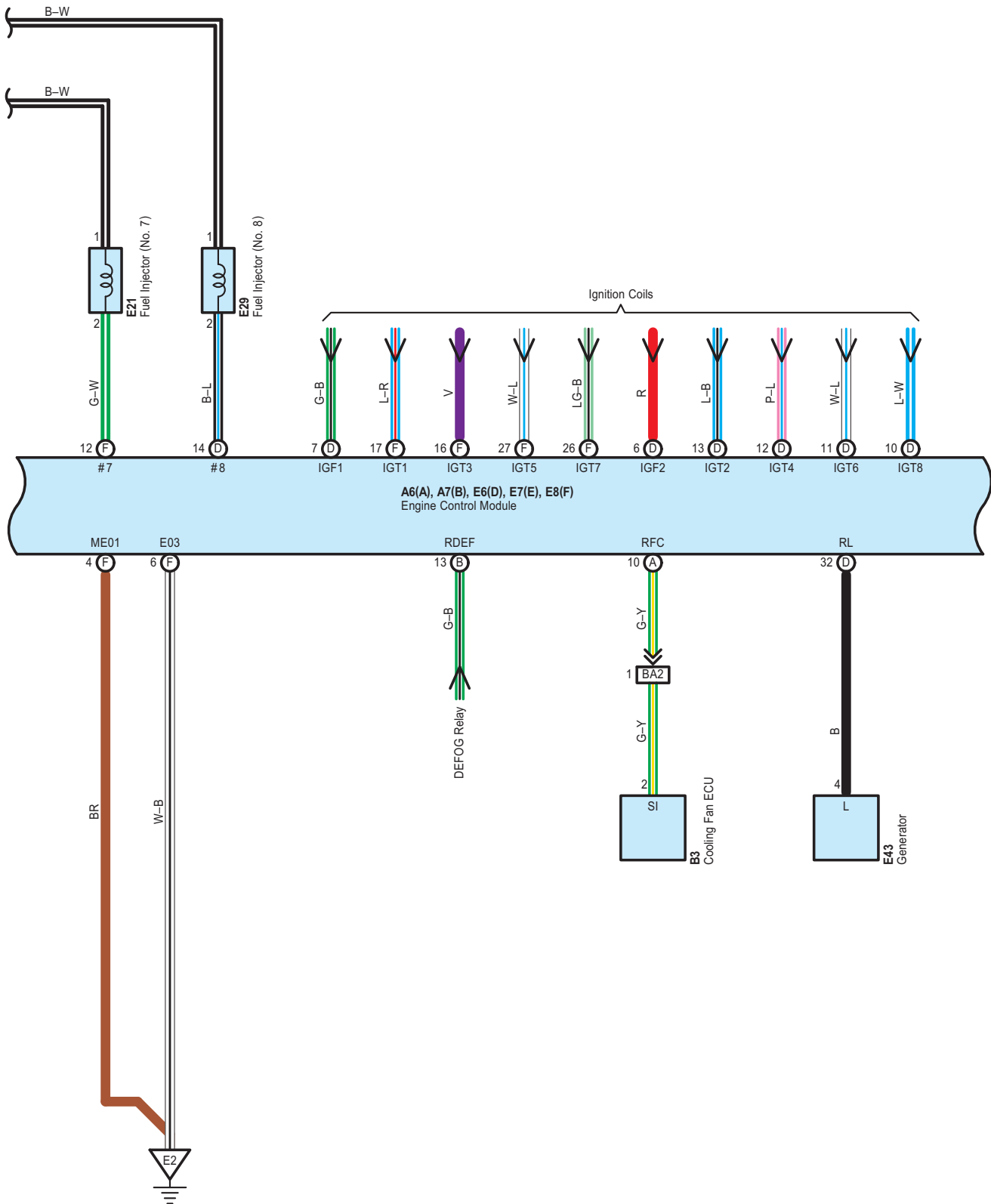

Engine Control <3UZ-FE>

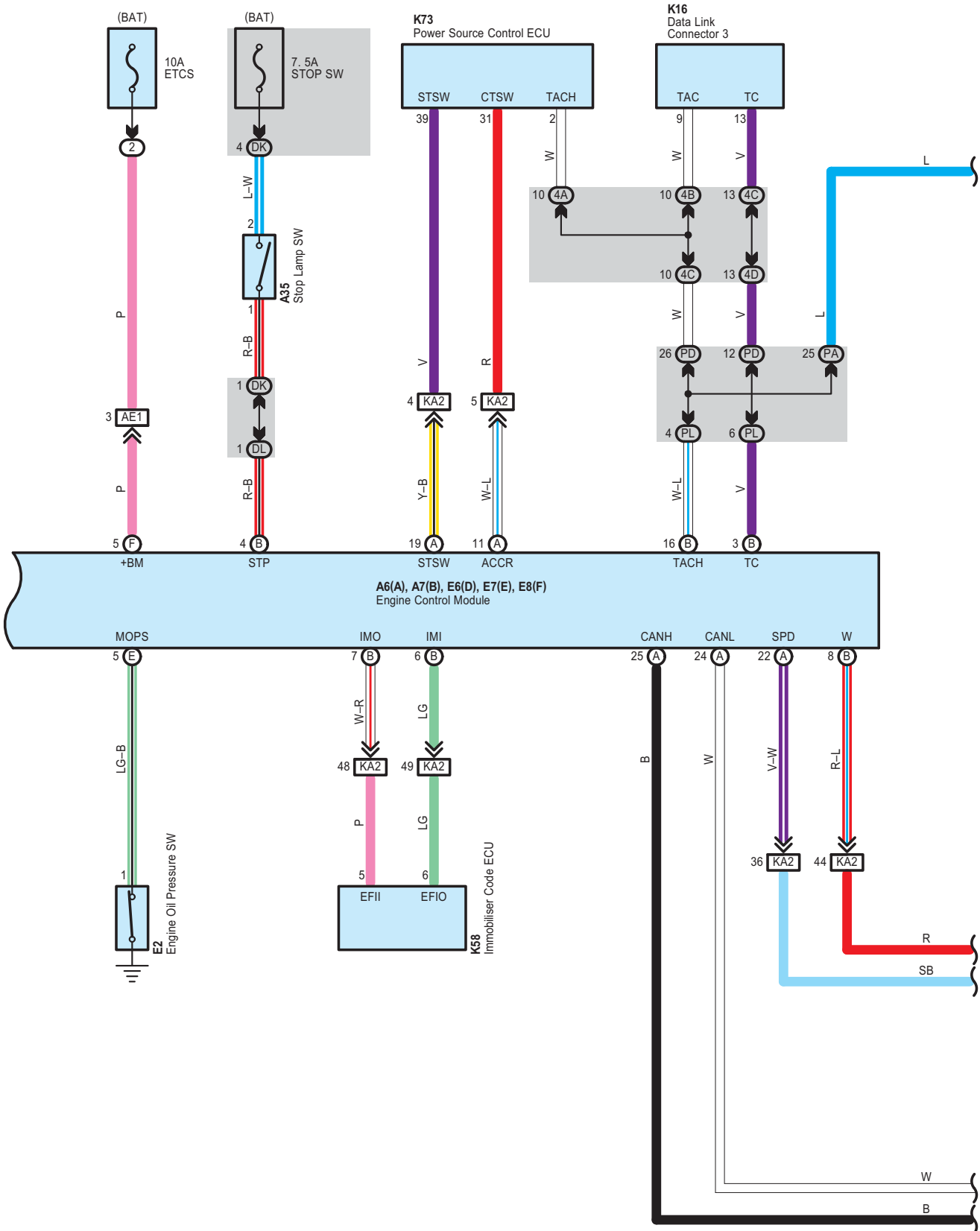

Engine Control <3UZ-FE>

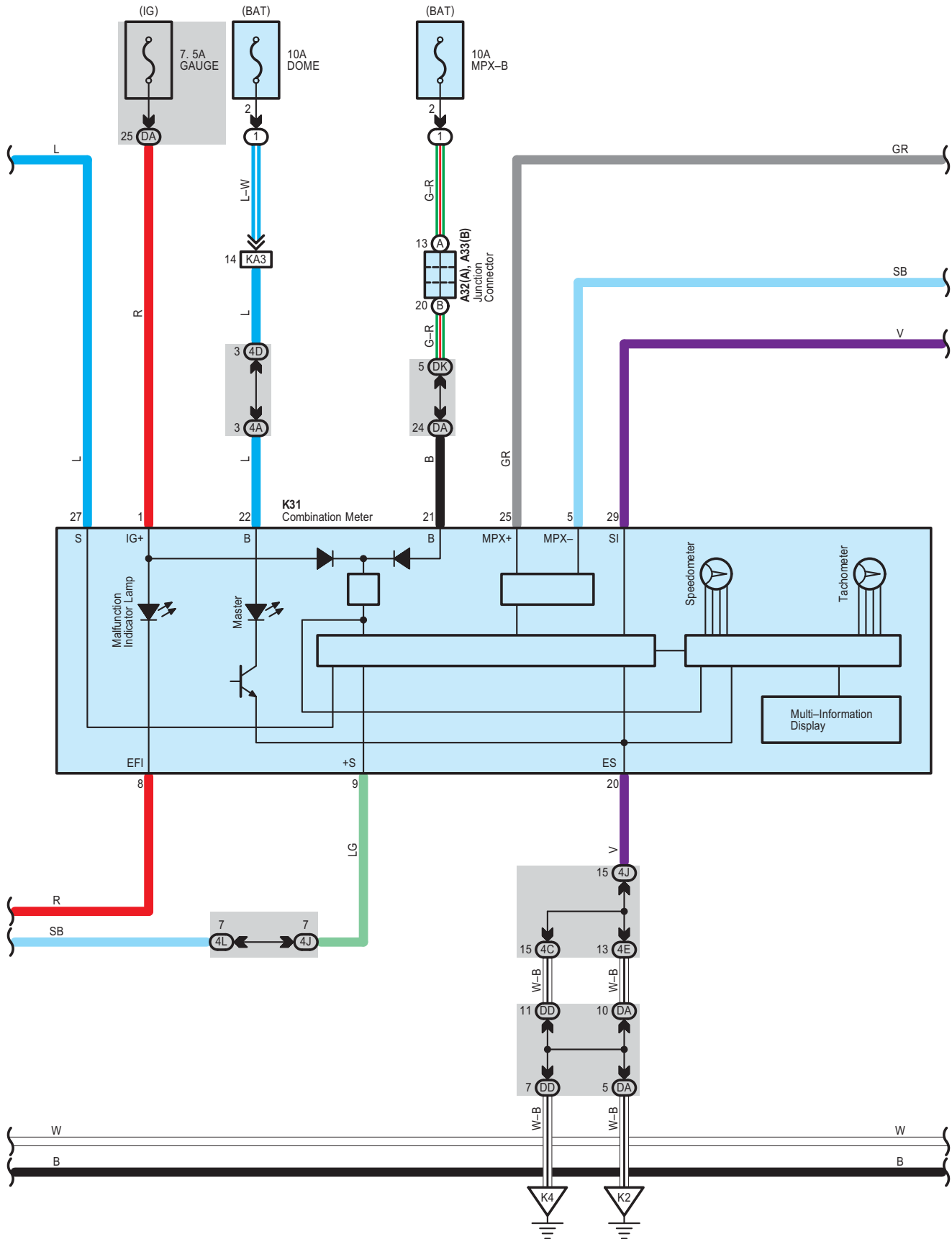

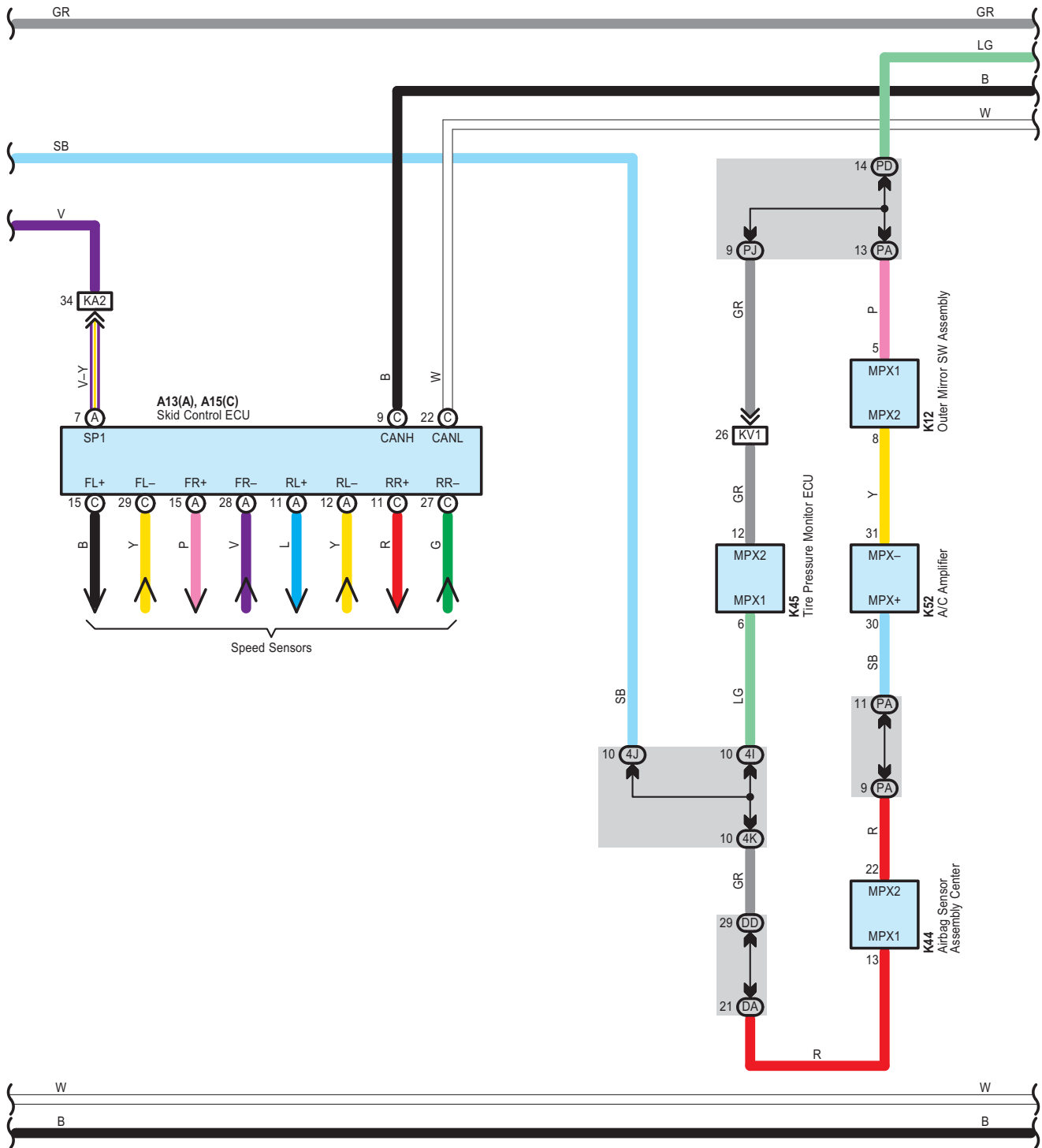

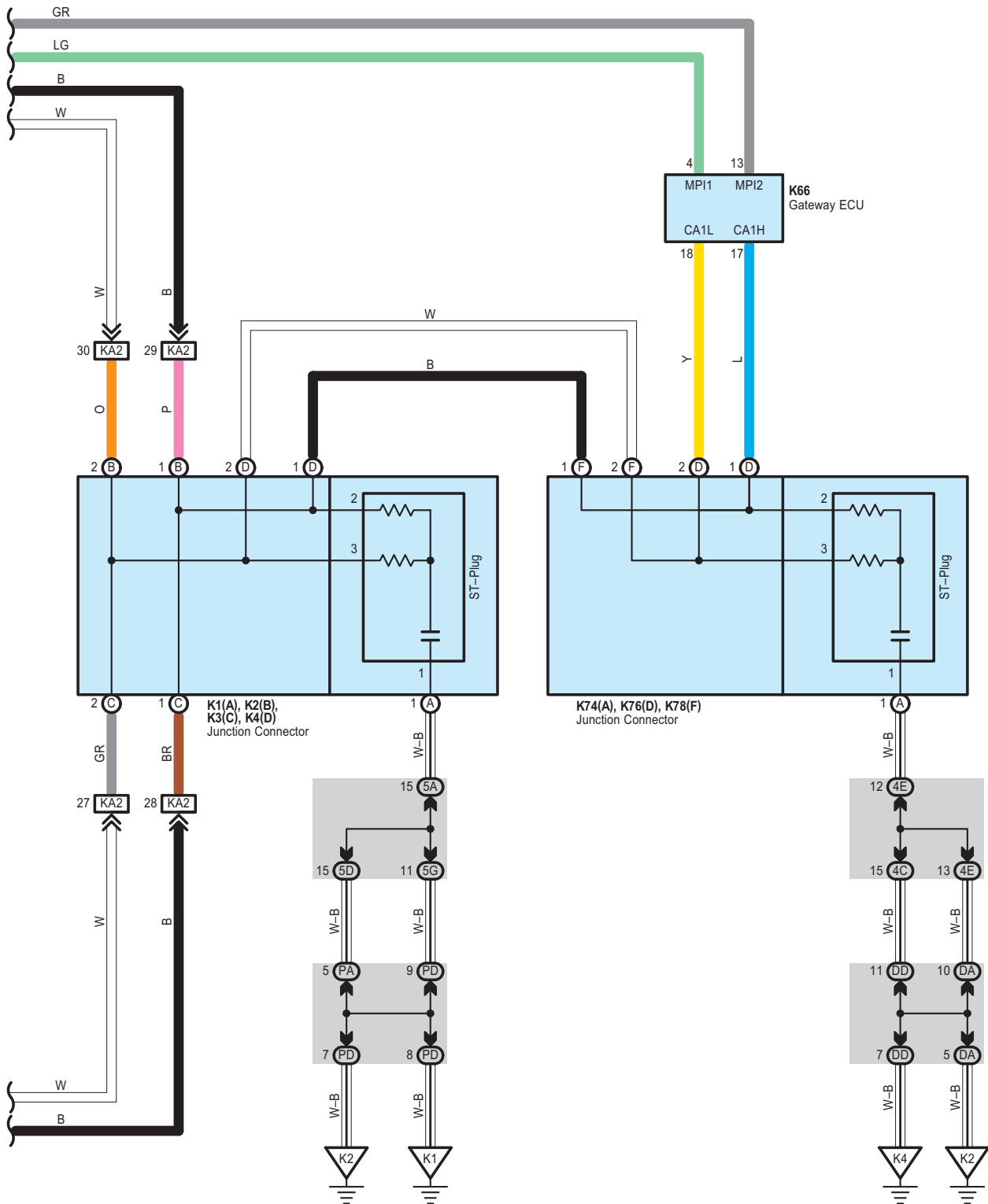

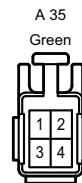
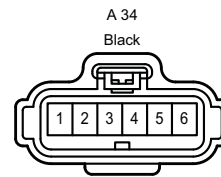
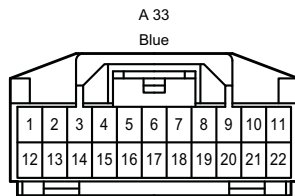
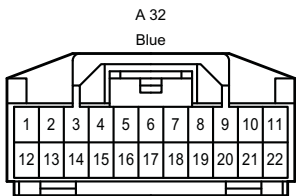
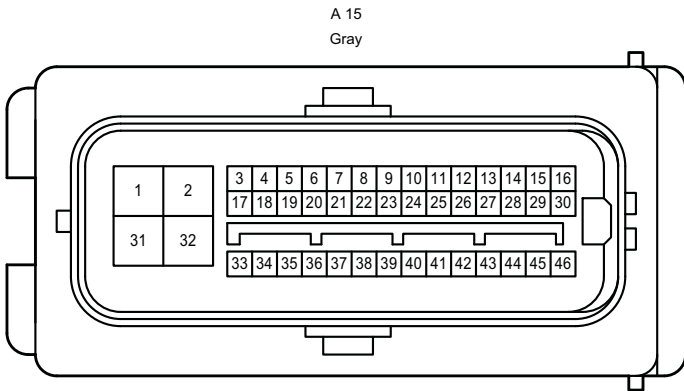
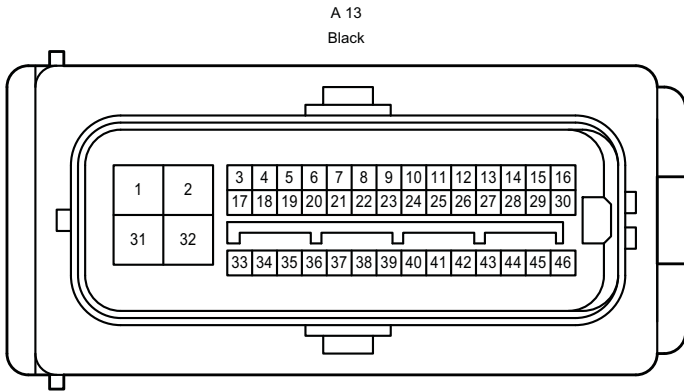
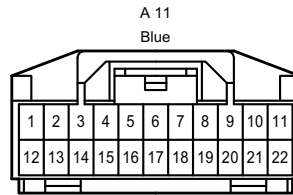
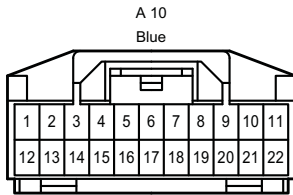
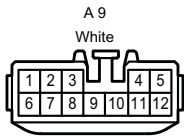
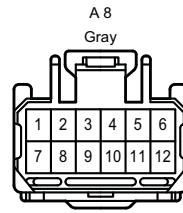
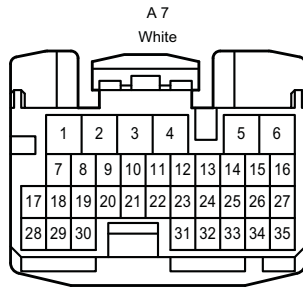
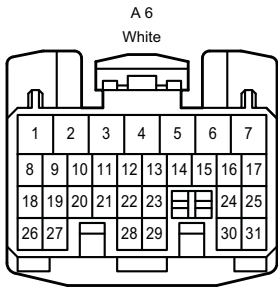

Engine Control <3UZ-FE>

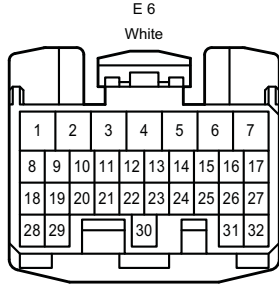
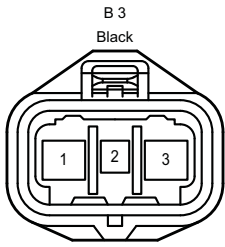

(3UZ-FE)

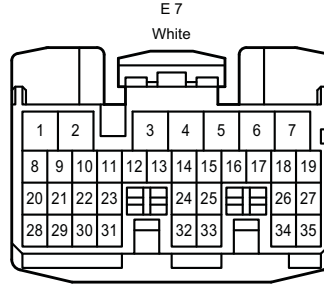

(3UZ-FE)

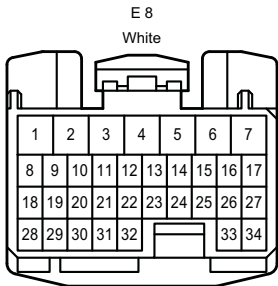

(3UZ-FE)

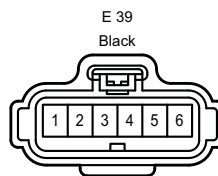
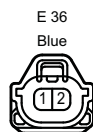
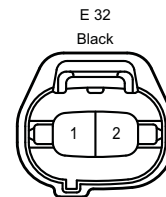
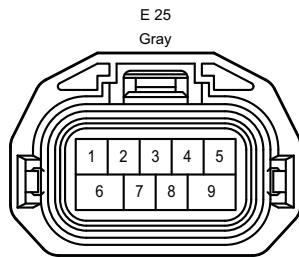
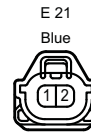
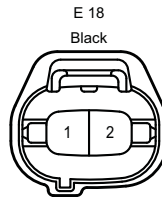
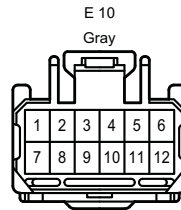
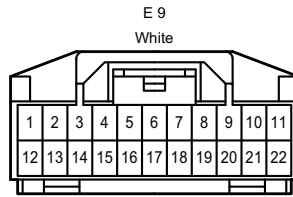

Engine Control <3UZ-FE>

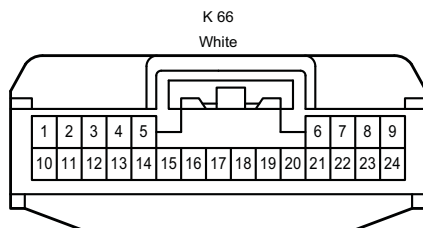
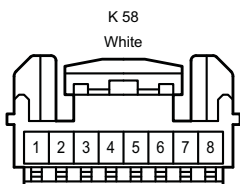
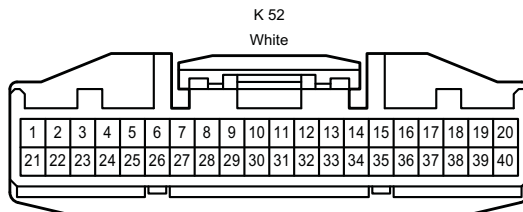
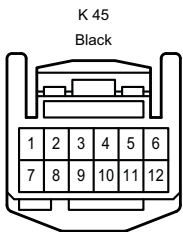
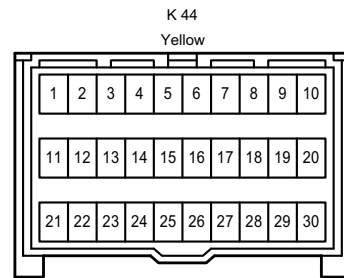
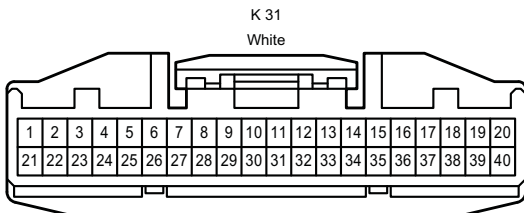
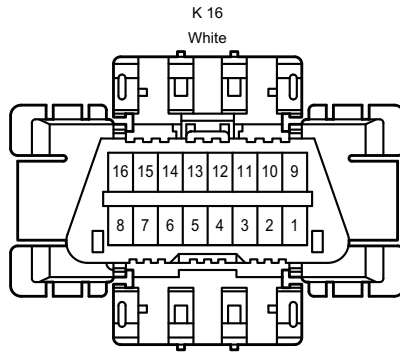
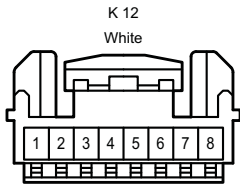
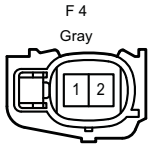
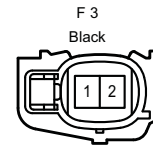
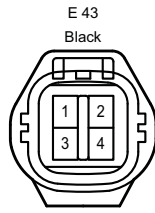
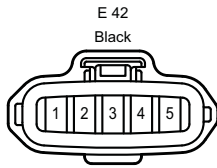

Engine Control <3UZ-FE>

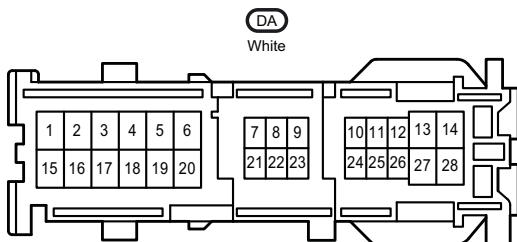
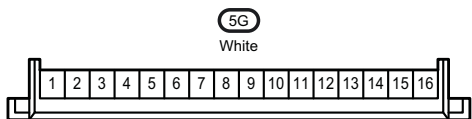
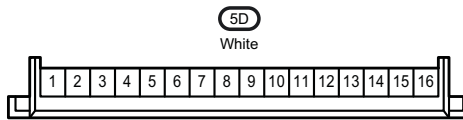
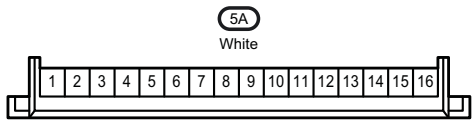
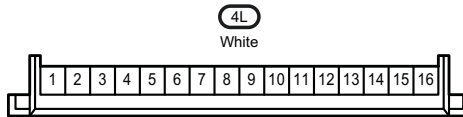
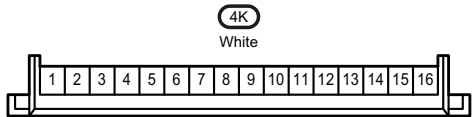
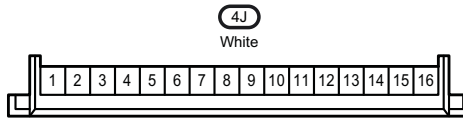
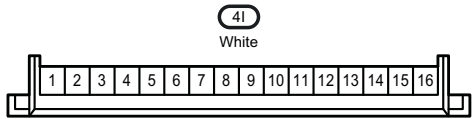
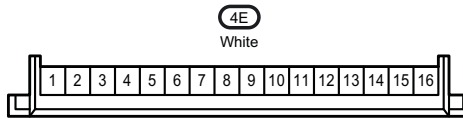
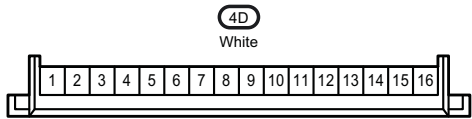
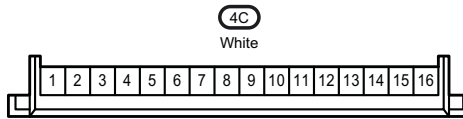
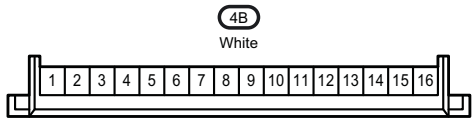
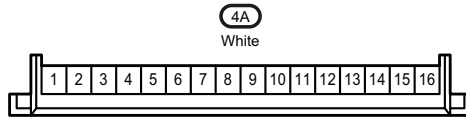
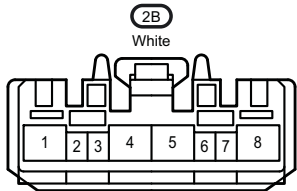
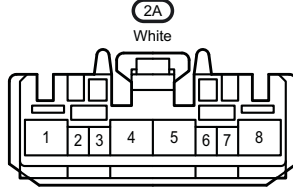
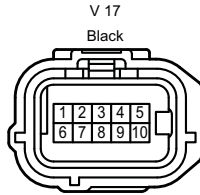
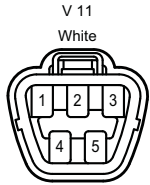
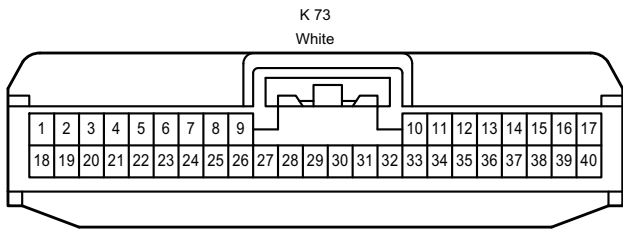

Engine Control <3UZ-FE>

DD

White

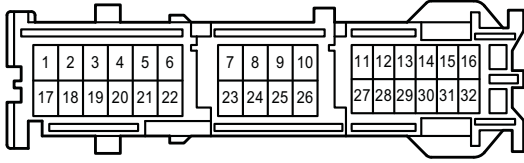

DK

Gray

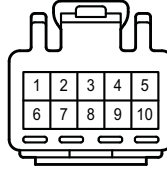

DL

Gray

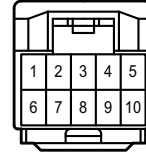

PA

White

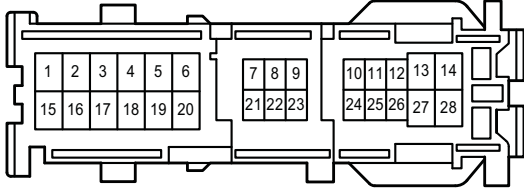

PD

White

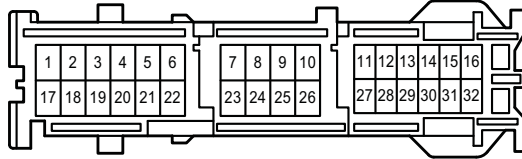

PJ

Gray

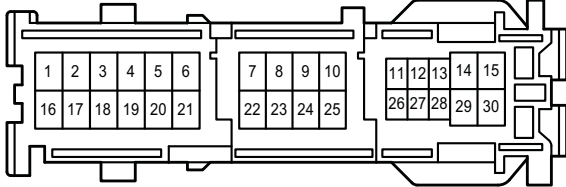

PL

Gray

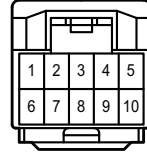

AE1

White

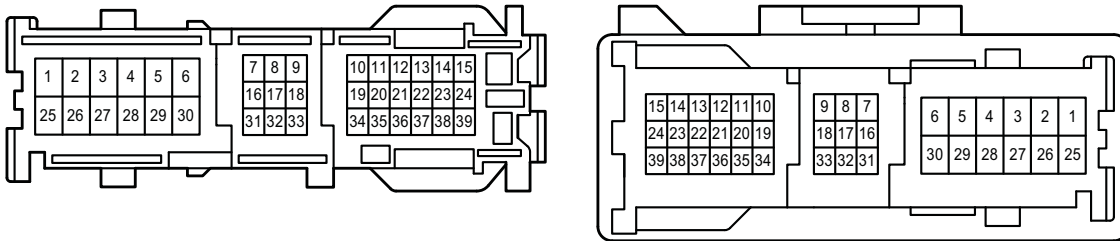

AV1

White

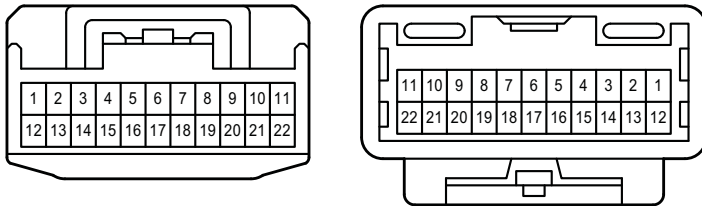

AV2

White

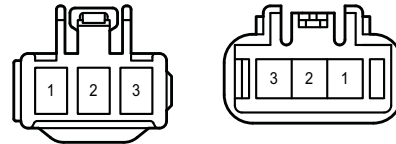

Engine Control <3UZ-FE>

BA2
Gray

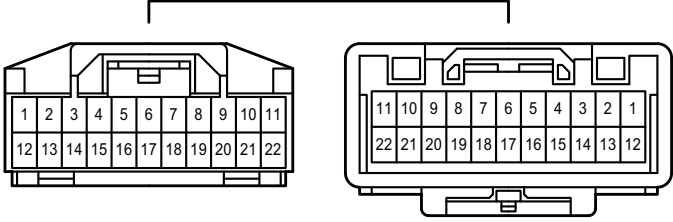

BA3
White

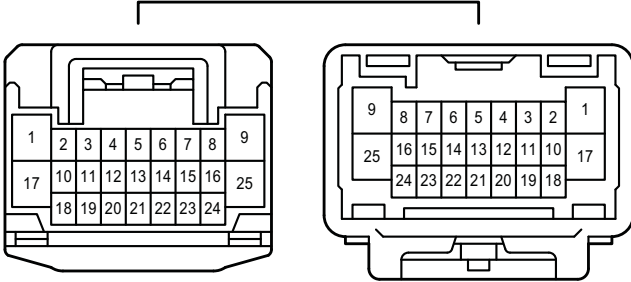

FE1
Black

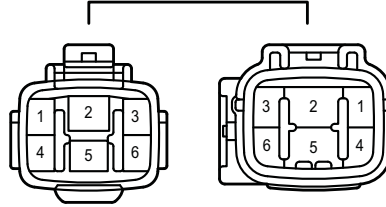

KA2
White

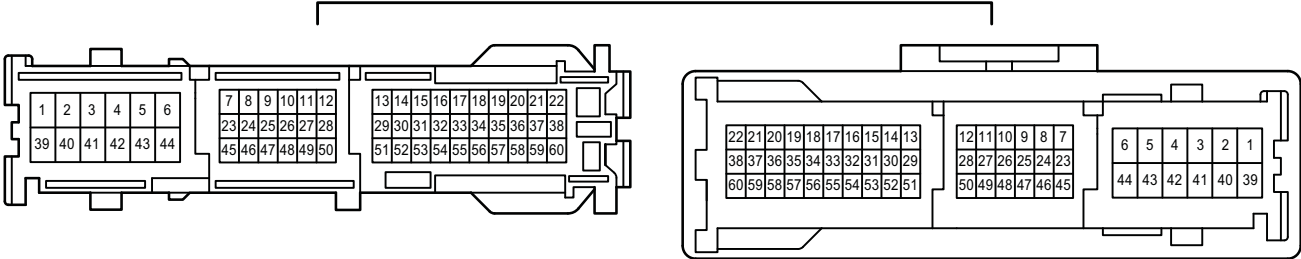

KA3
White

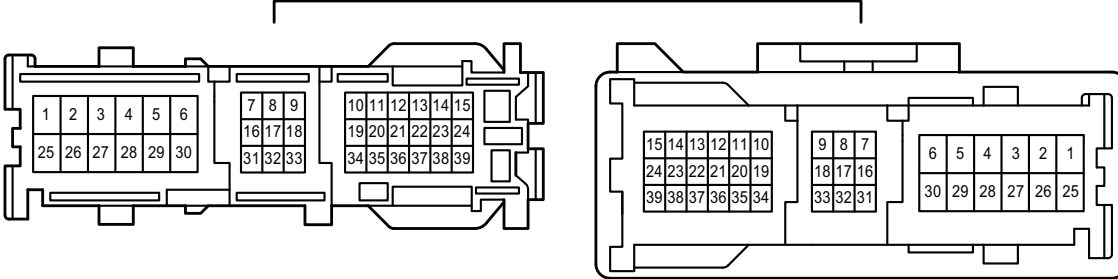

KV1
White

