

* 1 : w/ Rear Side Airbag
 * 2 : w/o Rear Side Airbag

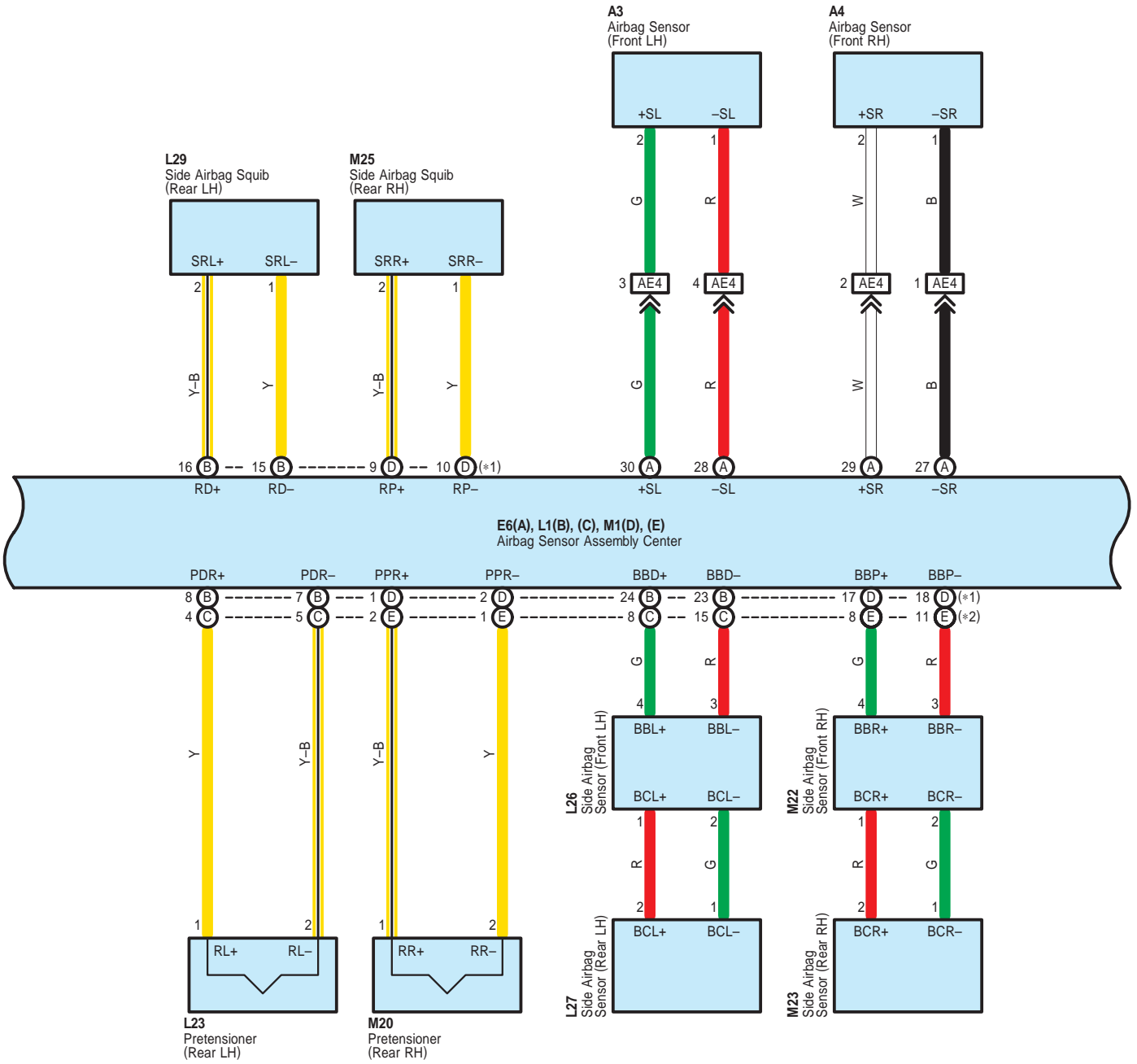

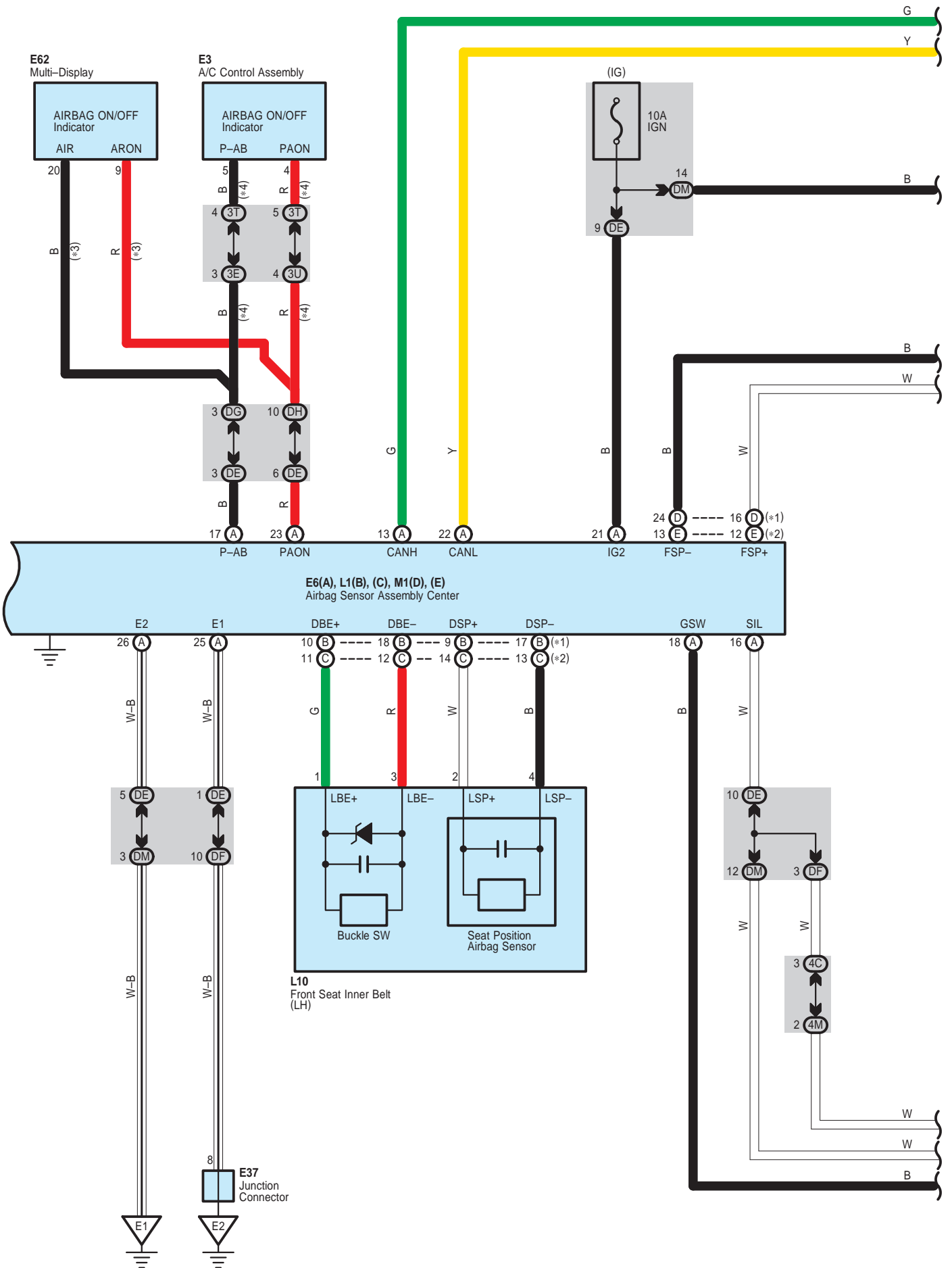

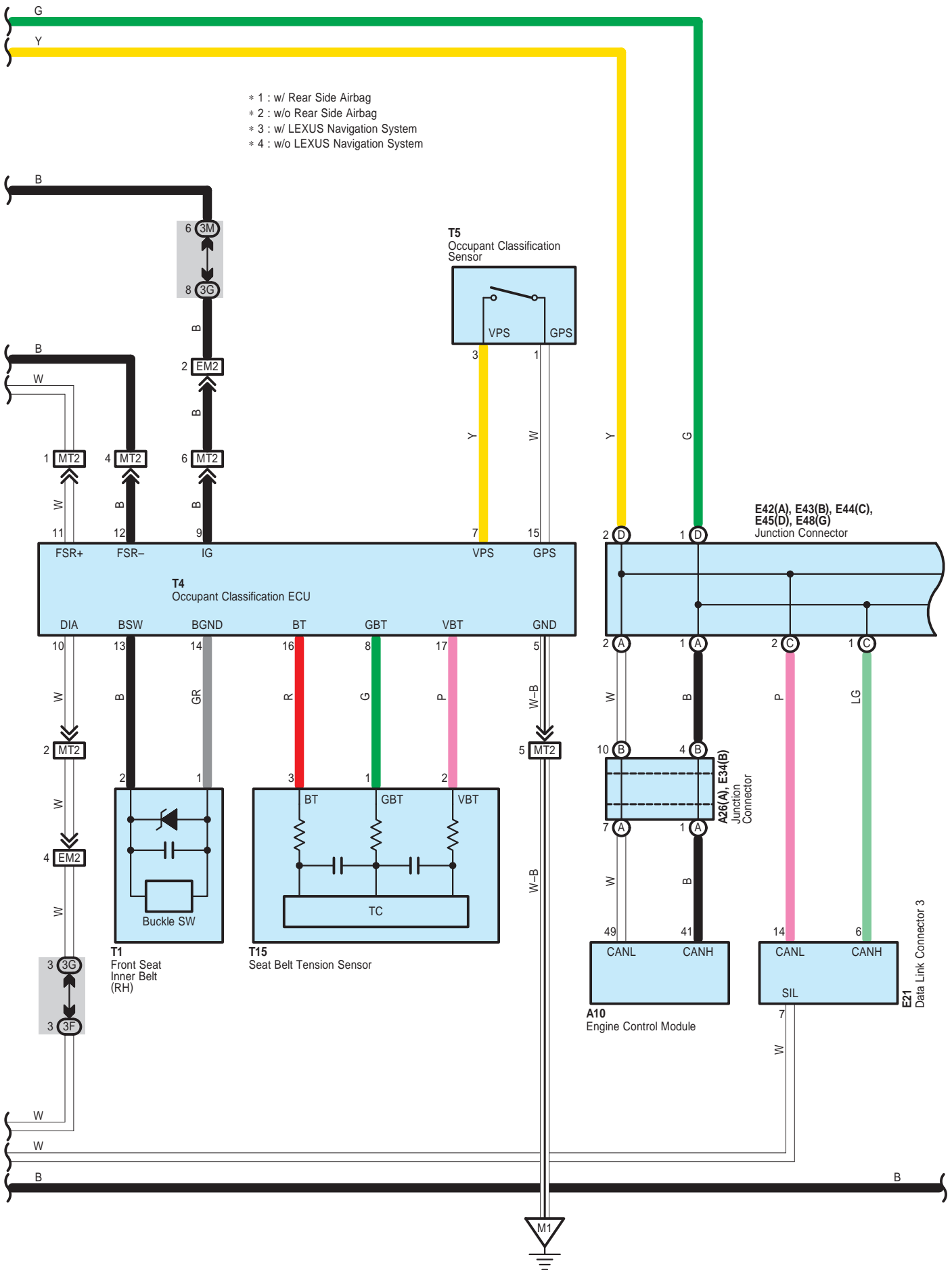

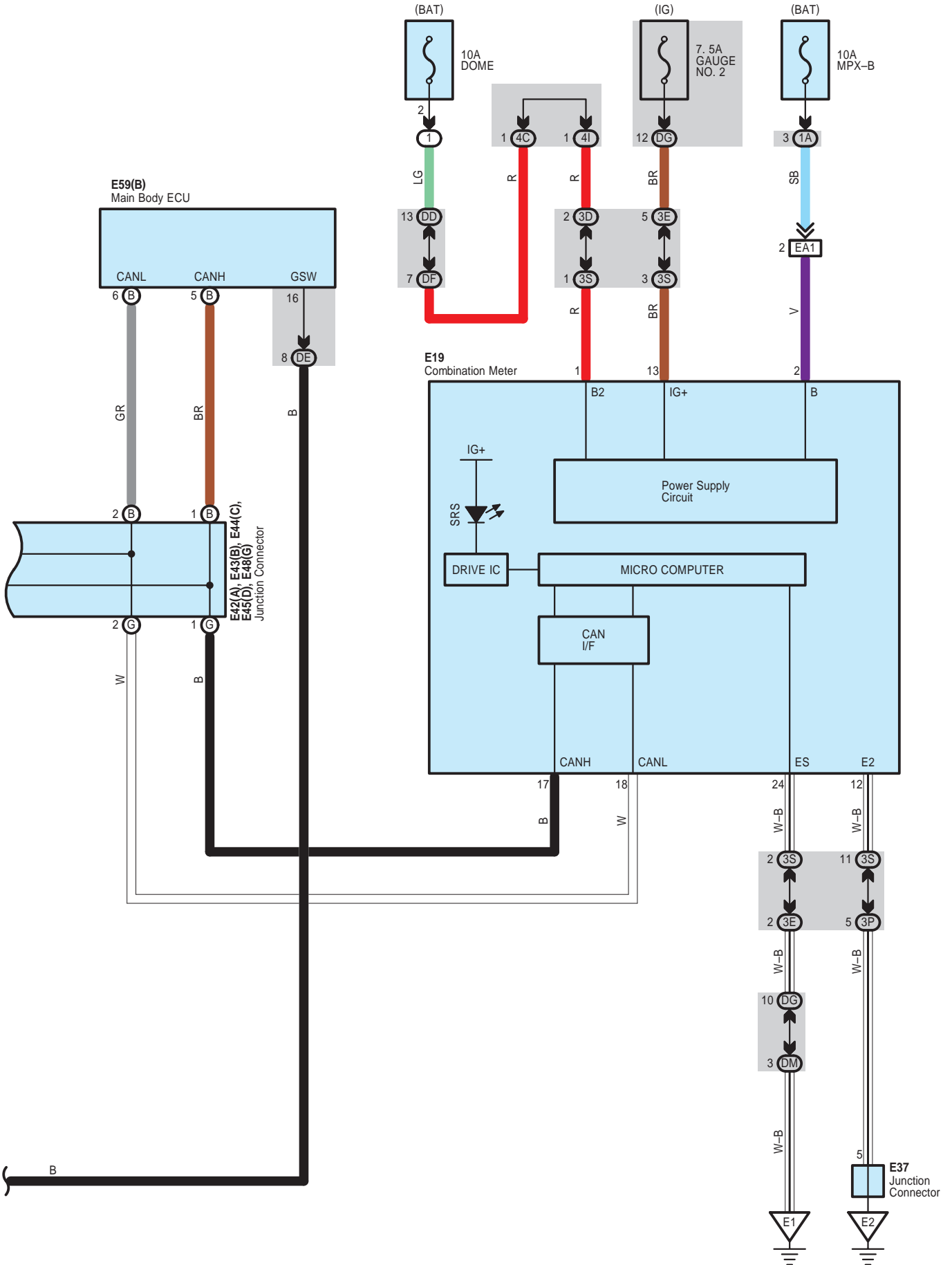

A 3
Yellow

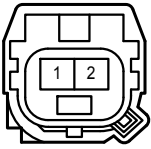

A 4
Yellow

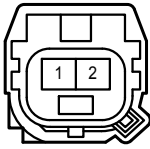

A 10
Black

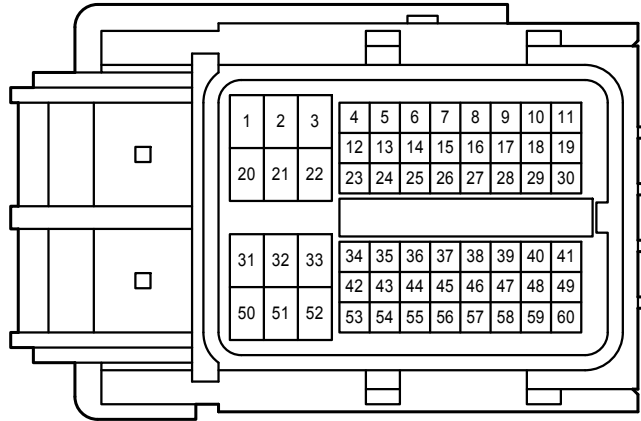

A 26
Blue

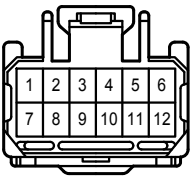

D 1
Orange

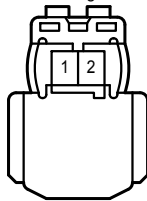

D 2
Black

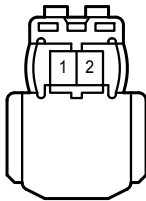

E 3
White

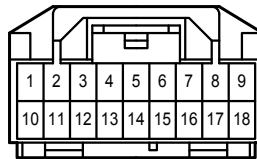

E 6
Yellow

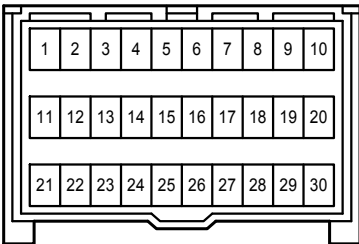

E 7
Black

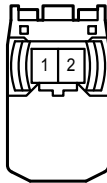

E 8
Black

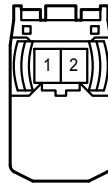

E 9
Yellow

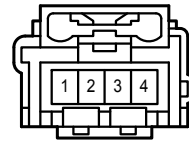

E 19
White

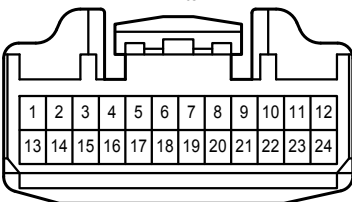

E 21
Black

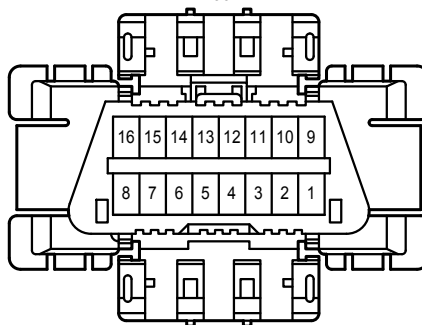

E 34
Blue

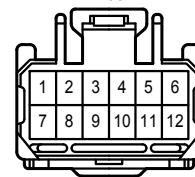

E 37
White

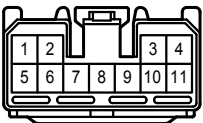

E 42
White

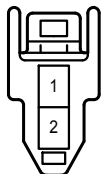

E 43
White

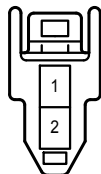

E 44
White

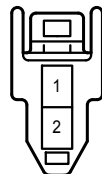

E 45
White

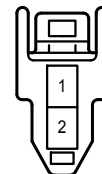

E 48
White

