

Last Modified: 7-13-2007		1.7 A
Service Category: Vehicle Interior	Section: Interior Panels/Trim	
Model Year: 2008	Model: ES350	Doc ID: RM00000292Z002X
Title: INTERIOR: ROOF HEADLINING: REMOVAL (2008 ES350)		

REMOVAL

1. REMOVE REAR SEAT CUSHION ASSEMBLY [INFO](#)
2. REMOVE REAR SEAT HEADREST ASSEMBLY
3. REMOVE REAR CENTER SEAT HEADREST ASSEMBLY
4. REMOVE REAR SEATBACK ASSEMBLY [INFO](#)
5. REMOVE SEAT BELT ANCHOR COVER CAP LH [INFO](#)
6. DISCONNECT FRONT SEAT OUTER BELT ASSEMBLY LH [INFO](#)
7. REMOVE FRONT SEAT HEADREST ASSEMBLY (for Driver Seat)
8. REMOVE FRONT SEAT OUTER TRACK BRACKET COVER LH [INFO](#)
9. REMOVE FRONT SEAT INNER TRACK BRACKET COVER LH [INFO](#)
10. REMOVE FRONT SEAT REAR OUTER TRACK BRACKET COVER LH [INFO](#)
11. REMOVE FRONT SEAT REAR INNER TRACK BRACKET COVER LH [INFO](#)
12. REMOVE FRONT SEAT ASSEMBLY LH [INFO](#)
13. REMOVE SEAT BELT ANCHOR COVER CAP RH [INFO](#)
14. DISCONNECT FRONT SEAT OUTER BELT ASSEMBLY RH [INFO](#)
15. REMOVE FRONT SEAT HEADREST ASSEMBLY (for Front Passenger Seat)
16. REMOVE FRONT SEAT OUTER TRACK BRACKET COVER RH [INFO](#)
17. REMOVE FRONT SEAT INNER TRACK BRACKET COVER RH [INFO](#)
18. REMOVE FRONT SEAT REAR OUTER TRACK BRACKET COVER RH [INFO](#)
19. REMOVE FRONT SEAT REAR INNER TRACK BRACKET COVER RH [INFO](#)
20. REMOVE FRONT SEAT ASSEMBLY RH [INFO](#)
21. REMOVE FRONT DOOR SCUFF PLATE LH

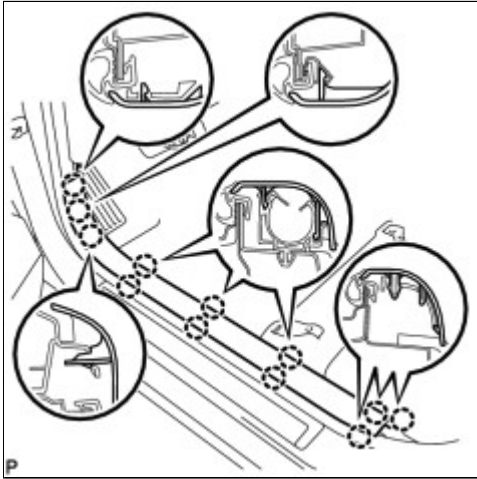

(a) Disengage the 12 claws and remove the front door scuff plate LH.

22. REMOVE FRONT DOOR OPENING TRIM COVER LH

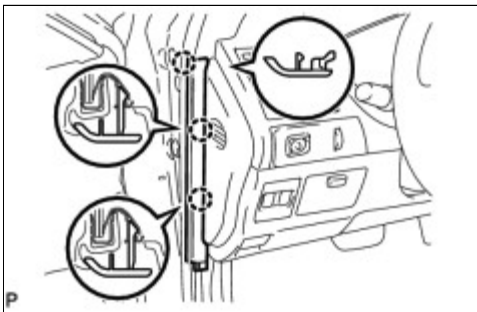

(a) Disengage the 3 claws and remove the front door opening trim cover LH.

23. REMOVE SIDE INSTRUMENT PANEL LH INFO

24. REMOVE FRONT PILLAR GARNISH LH

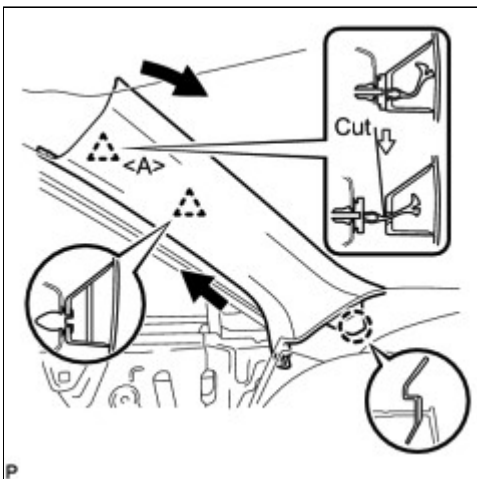

(a) Pull the upper portion of the garnish towards the inside of the cabin and disengage the 2 clips.

(b) Cut off clip <A>.

(c) Disengage the claw and remove the front pillar garnish LH.

(d) Remove clip <A> from the vehicle body.

(e) Protect the curtain shield airbag assembly.

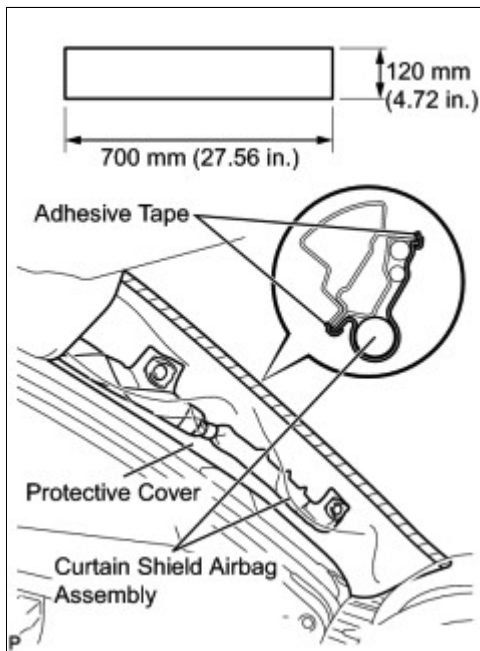

(1) Thoroughly cover the airbag with a cloth or nylon sheet and fix the ends of the cover with adhesive tape, as shown in the illustration.

NOTICE:

Cover the curtain shield airbag with a protective cover as soon as the front pillar garnish is removed.

25. REMOVE REAR DOOR SCUFF PLATE LH

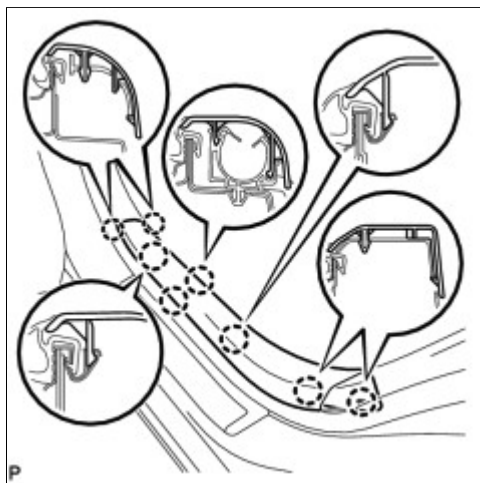

(a) Disengage the 8 claws and remove the rear door scuff plate LH.

26. REMOVE LOWER CENTER PILLAR GARNISH LH

(a) Disengage the 2 claws and 5 clips, and remove the lower center pillar garnish LH.

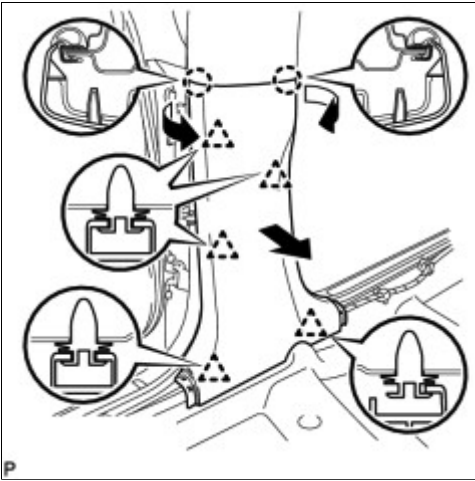

27. REMOVE UPPER CENTER PILLAR GARNISH LH



(a) Remove the 2 screws.

(b) Pull the lower part of the pillar garnish toward the inside of the vehicle.

(c) Using a clip remover, disengage the clip and remove the upper center pillar garnish LH.

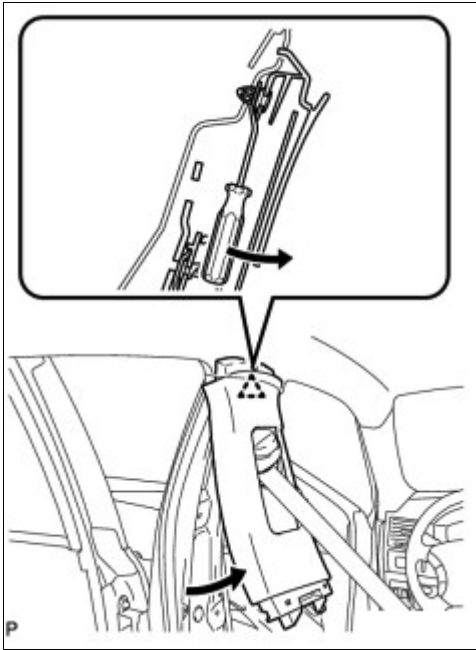

28. REMOVE REAR SEAT SIDE GARNISH LH (w/o Rear Seat Side Airbag)

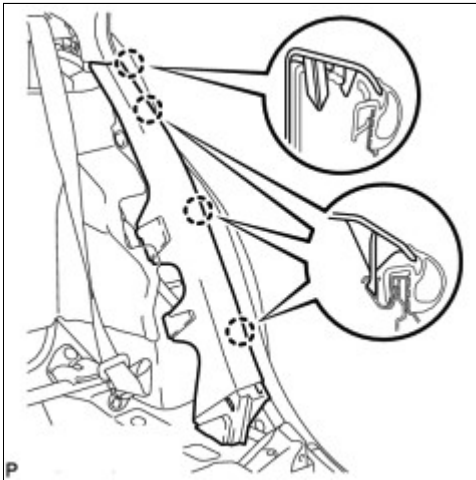

(a) Disengage the 4 claws and rear seat side garnish LH.

29. REMOVE REAR SEAT SIDE AIRBAG ASSEMBLY LH (w/ Rear Seat Side Airbag)



30. REMOVE ROOF SIDE INNER GARNISH ASSEMBLY LH

(a) Disengage the 5 clips and claw, and remove the roof side inner garnish assembly LH.

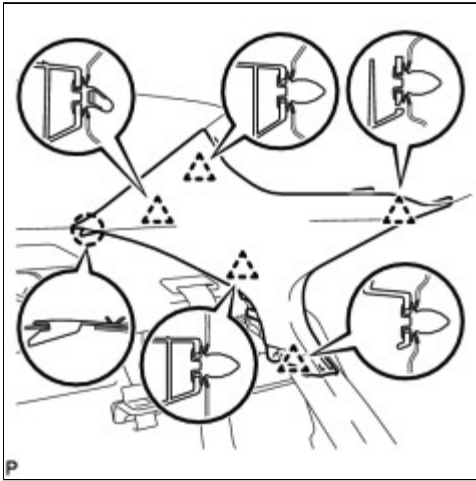

31. REMOVE FRONT DOOR SCUFF PLATE RH

HINT:

Use the same procedure for the RH side and the LH side.

32. REMOVE FRONT DOOR OPENING TRIM COVER RH

HINT:

Use the same procedure for the RH side and the LH side.

33. REMOVE SIDE INSTRUMENT PANEL RH INFO

34. REMOVE FRONT PILLAR GARNISH RH

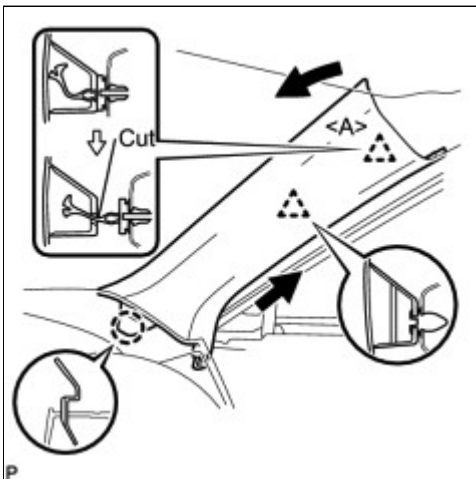

(a) Pull the upper portion of the garnish towards the inside of the cabin and disengage the 2 clips.

(b) Cut off clip <A>.

(c) Disengage the claw and remove the front pillar garnish RH.

(d) Remove the clip <A> from the vehicle body.

(e) Protect the curtain shield airbag assembly.

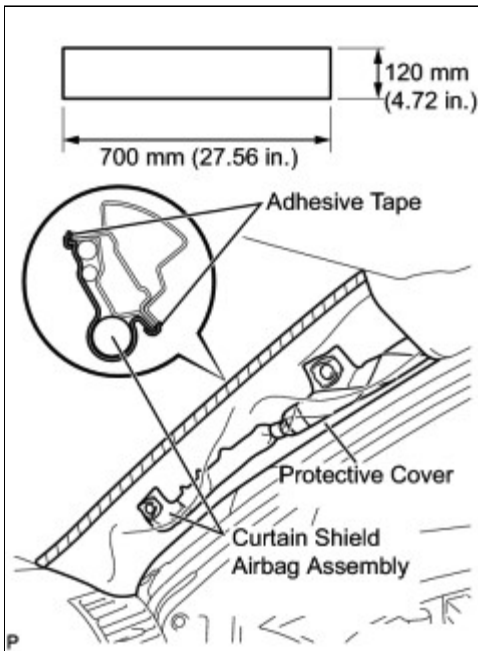

(1) Thoroughly cover the airbag with a cloth or nylon sheet and fix the ends of the cover with adhesive tape, as shown in the illustration.

NOTICE:

Cover the curtain shield airbag with a protective cover as soon as the front pillar garnish is removed.

35. REMOVE REAR DOOR SCUFF PLATE RH

HINT:

Use the same procedure for the RH side and the LH side.

36. REMOVE LOWER CENTER PILLAR GARNISH RH

HINT:

Use the same procedure for the RH side and the LH side.

37. REMOVE UPPER CENTER PILLAR GARNISH RH

HINT:

Use the same procedure for the RH side and the LH side.

38. REMOVE REAR SEAT SIDE GARNISH RH (w/o Rear Seat Side Airbag)

HINT:

Use the same procedure for the RH side and the LH side.

39. REMOVE REAR SEAT SIDE AIRBAG ASSEMBLY RH (w/ Rear Seat Side Airbag)





















HINT:

Use the same procedure for the RH side and the LH side.

40. REMOVE ROOF SIDE INNER GARNISH ASSEMBLY RH

HINT:

Use the same procedure for the RH side and the LH side.

41. REMOVE INSTRUMENT PANEL FINISH PANEL END LH 
42. REMOVE INSTRUMENT PANEL FINISH PANEL END RH 
43. REMOVE SHIFT LEVER KNOB SUB-ASSEMBLY 
44. REMOVE UPPER CONSOLE PANEL ASSEMBLY WITH FRONT ASH RECEPTACLE 
45. REMOVE HEATER SEAT SWITCH CONSOLE BASE (w/o Seat Heater System) 
46. REMOVE HEATER SEAT SWITCH CONSOLE BASE (w/ Seat Heater System) 
47. REMOVE CONSOLE BOX POCKET 
48. REMOVE CONSOLE BOX CARPET 
49. REMOVE CONSOLE REAR END PANEL SUB-ASSEMBLY 
50. REMOVE REAR CONSOLE BOX ASSEMBLY 
51. REMOVE NO. 2 CONSOLE BOX DUCT 
52. REMOVE NO. 3 CONSOLE BOX DUCT 
53. DISCONNECT TRANSMISSION CONTROL CABLE ASSEMBLY 
54. REMOVE SHIFT LEVER ASSEMBLY 
55. REMOVE FLOOR CARPET BRACKET LH 
56. REMOVE FLOOR CARPET BRACKET RH 
57. REMOVE LUGGAGE COMPARTMENT FLOOR MAT (w/ DVD Player)
58. REMOVE SPARE WHEEL COVER TRAY (w/ DVD Player)
59. REMOVE LUGGAGE HOLD BELT STRIKER ASSEMBLY (w/ DVD Player) 
60. REMOVE NO. 1 LUGGAGE COMPARTMENT TRIM HOOK (w/ DVD Player) 
61. REMOVE REAR FLOOR FINISH PLATE (w/ DVD Player) 
62. REMOVE LUGGAGE COMPARTMENT INNER TRIM COVER RH (w/ DVD Player) 
63. DISCONNECT STEREO COMPONENT AMPLIFIER ASSEMBLY CONNECTOR (w/ DVD Player)

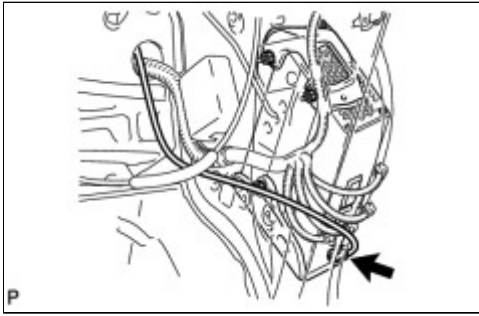

(a) Disconnect the stereo component amplifier assembly connector.

64. REMOVE INNER REAR VIEW MIRROR STAY HOLDER COVER INFO

65. REMOVE RAIN SENSOR COVER (w/ Rain Sensor) INFO

66. REMOVE ROOF CONSOLE BOX ASSEMBLY

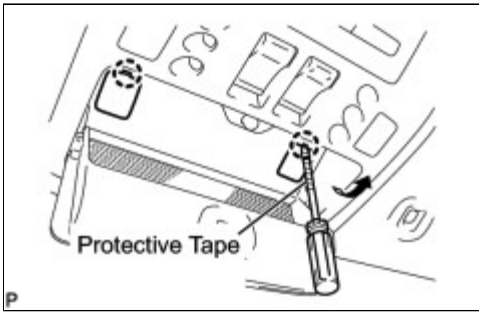

(a) Using a screwdriver, disengage the 2 claws and open the 2 covers.

HINT:

Tape the screwdriver tip before use.

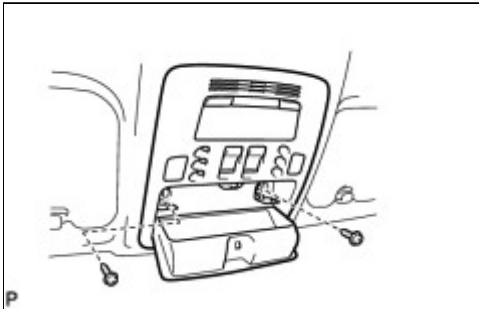

(b) Remove the 2 screws.

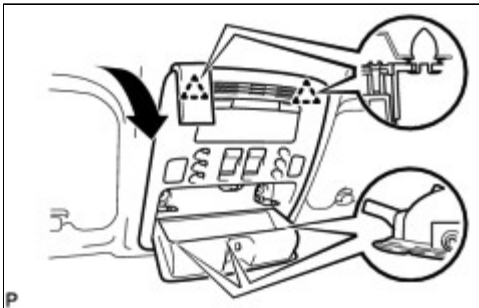

(c) Using a moulding remover, disengage the 2 clips.

(d) Disconnect the connectors and remove the roof console box assembly.

67. REMOVE VISOR BRACKET COVER

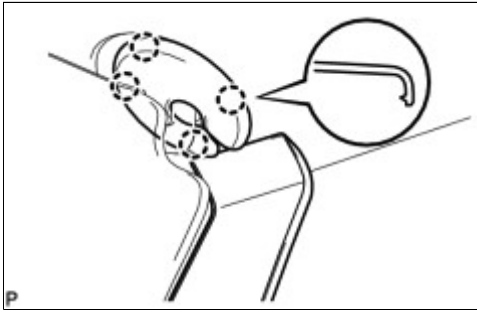

(a) Using a moulding remover, disengage the 4 claws and remove the visor bracket cover.

HINT:

Use the same procedure to remove the cover on the other side.

68. REMOVE VISOR ASSEMBLY LH

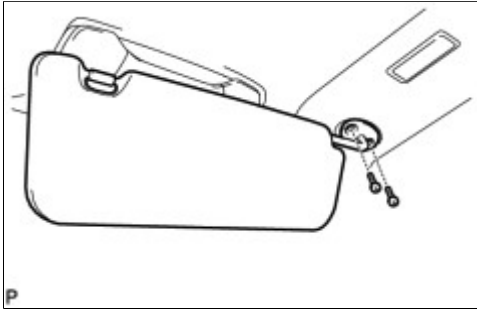

(a) Remove the 2 screws and visor assembly LH.

69. REMOVE VISOR ASSEMBLY RH

HINT:

Use the same procedure for the RH side and the LH side.

70. REMOVE VISOR HOLDER

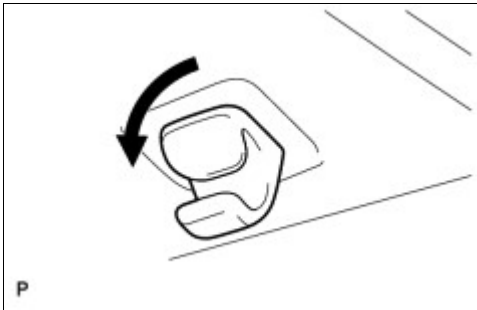

(a) Remove the visor holder by turning it counterclockwise.

HINT:

Use the same procedure to remove the hook on the other side.

71. REMOVE COAT HOOK

(a) Remove the screw and coat hook.

HINT:

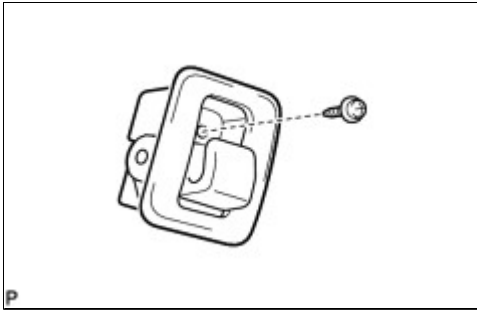

Use the same procedure to remove the coat hook on the other side.

72. REMOVE SPOT LIGHT ASSEMBLY (for Standard)

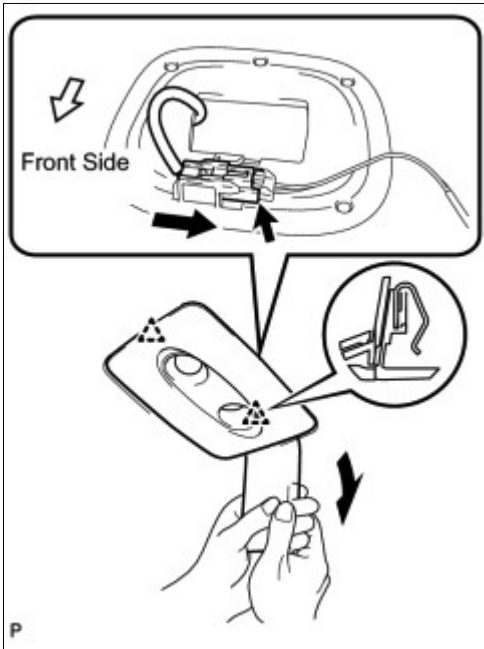

(a) Using a moulding remover, disengage the 2 clips.

(b) Disconnect the connector and remove the spot light assembly.

73. REMOVE SPOT LIGHT ASSEMBLY (for Glass Roof)

(a) Using a moulding remover, disengage the 2 clips.

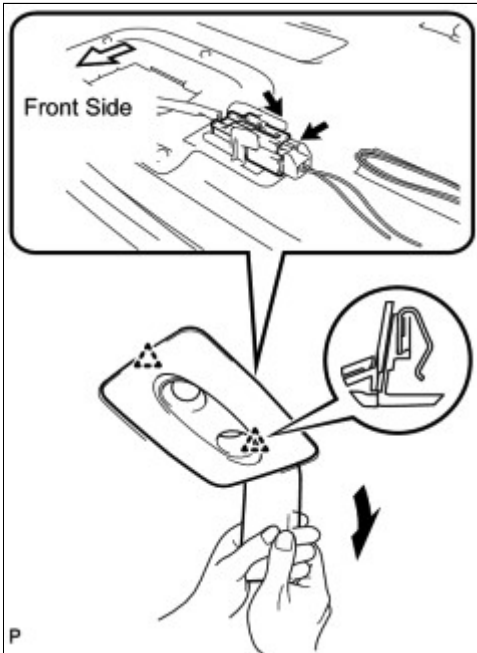

(b) Disconnect the connector and remove the spot light assembly.

74. REMOVE ASSIST GRIP SUB-ASSEMBLY

(a) Using a screwdriver, disengage the 4 claws and remove the 2 assist grip covers.

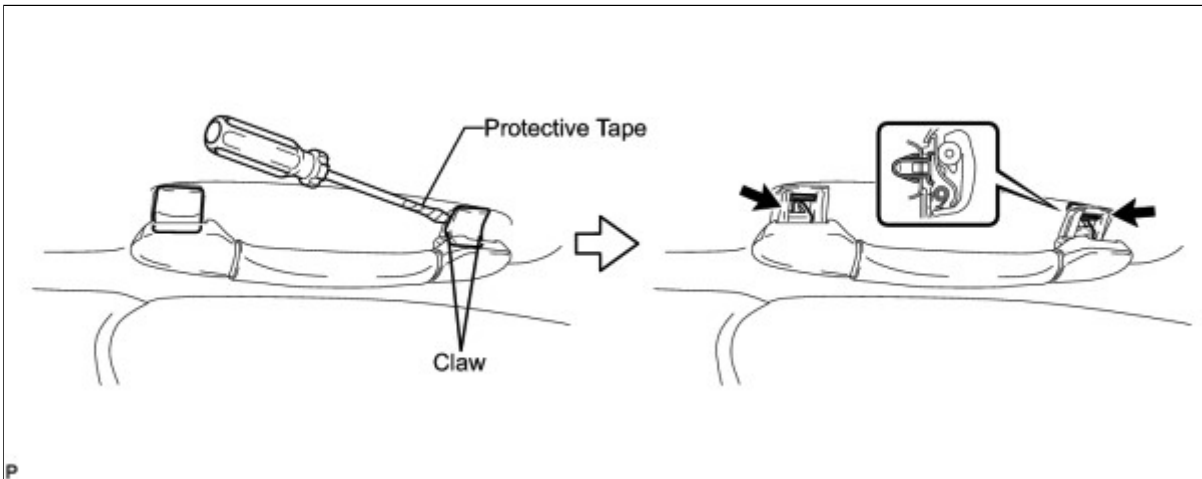

HINT:

Tape the screwdriver tip before use.

(b) Disengage the 2 clips and remove the assist grip sub-assembly.

HINT:

Use the same procedure for the other 3 assist grips.

75. REMOVE ROOF HEADLINING ASSEMBLY (for Standard)

(a) Disconnect the No. 1 roof wire connector and disengage each clamp from the front pillar LH.

- (b) Disconnect the antenna cord sub-assembly connector and disengage each clamp from the front pillar RH.
- (c) Disconnect the antenna cord sub-assembly connector and disengage the clamp from the rear pillar RH.
- (d) Disengage the 12 claws, 4 clips, and 11 fasteners.

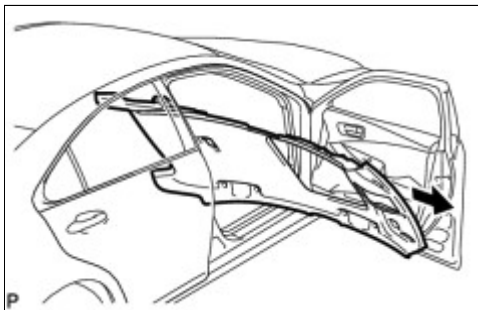
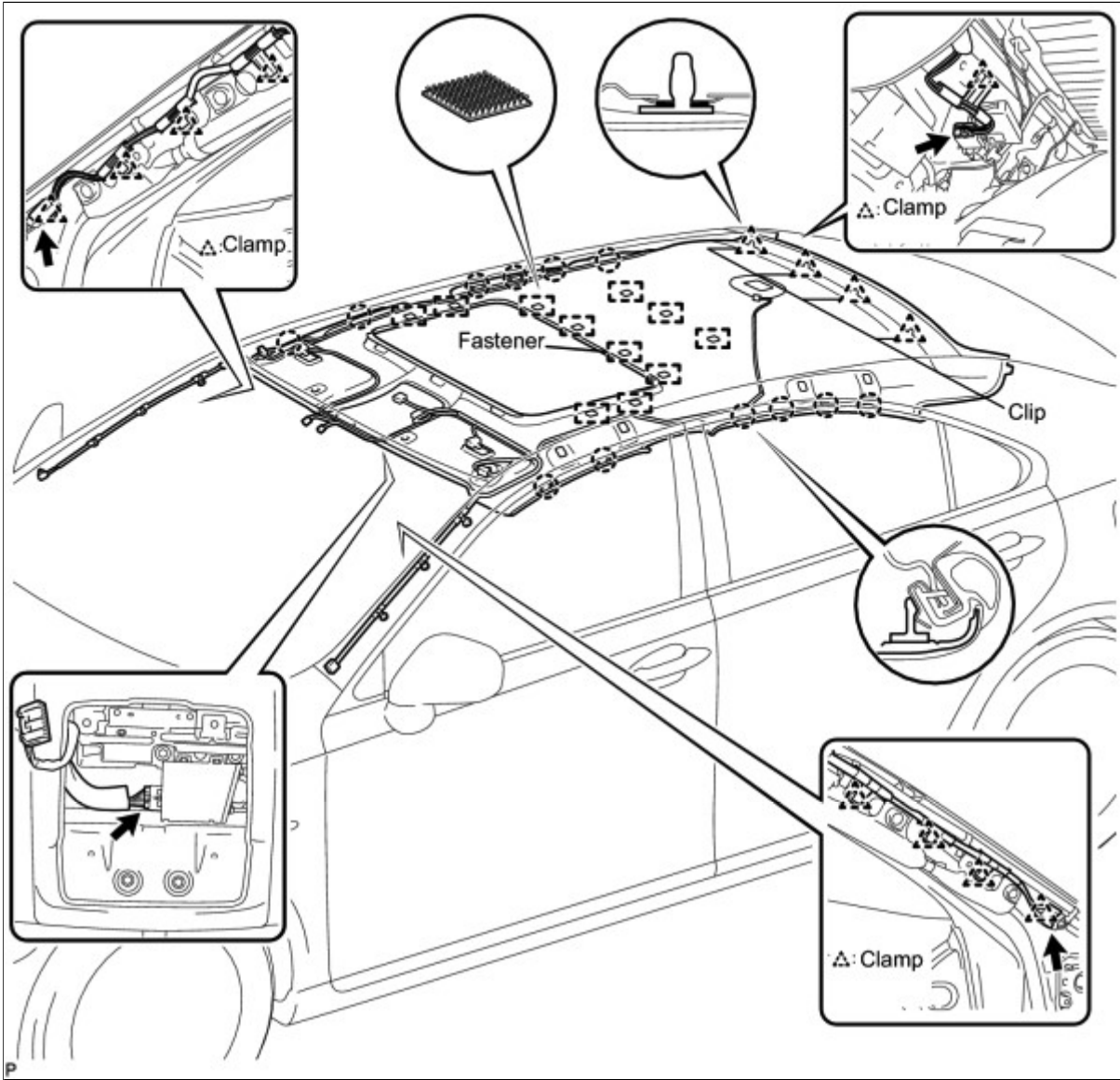

- (e) Remove the roof headlining assembly from the vehicle through the front right door.

76. REMOVE ROOF HEADLINING ASSEMBLY (for Glass Roof)

- (a) Disconnect the No. 1 roof wire connector and disengage each clamp from the front pillar LH.
- (b) Disconnect the antenna cord sub-assembly connector and disengage the clamp from the rear pillar RH.

(c) Disengage the 12 claws, 4 clips, and 21 fasteners.

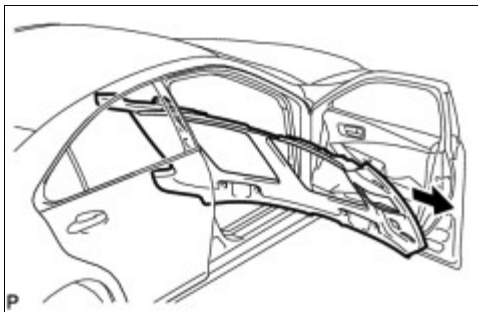
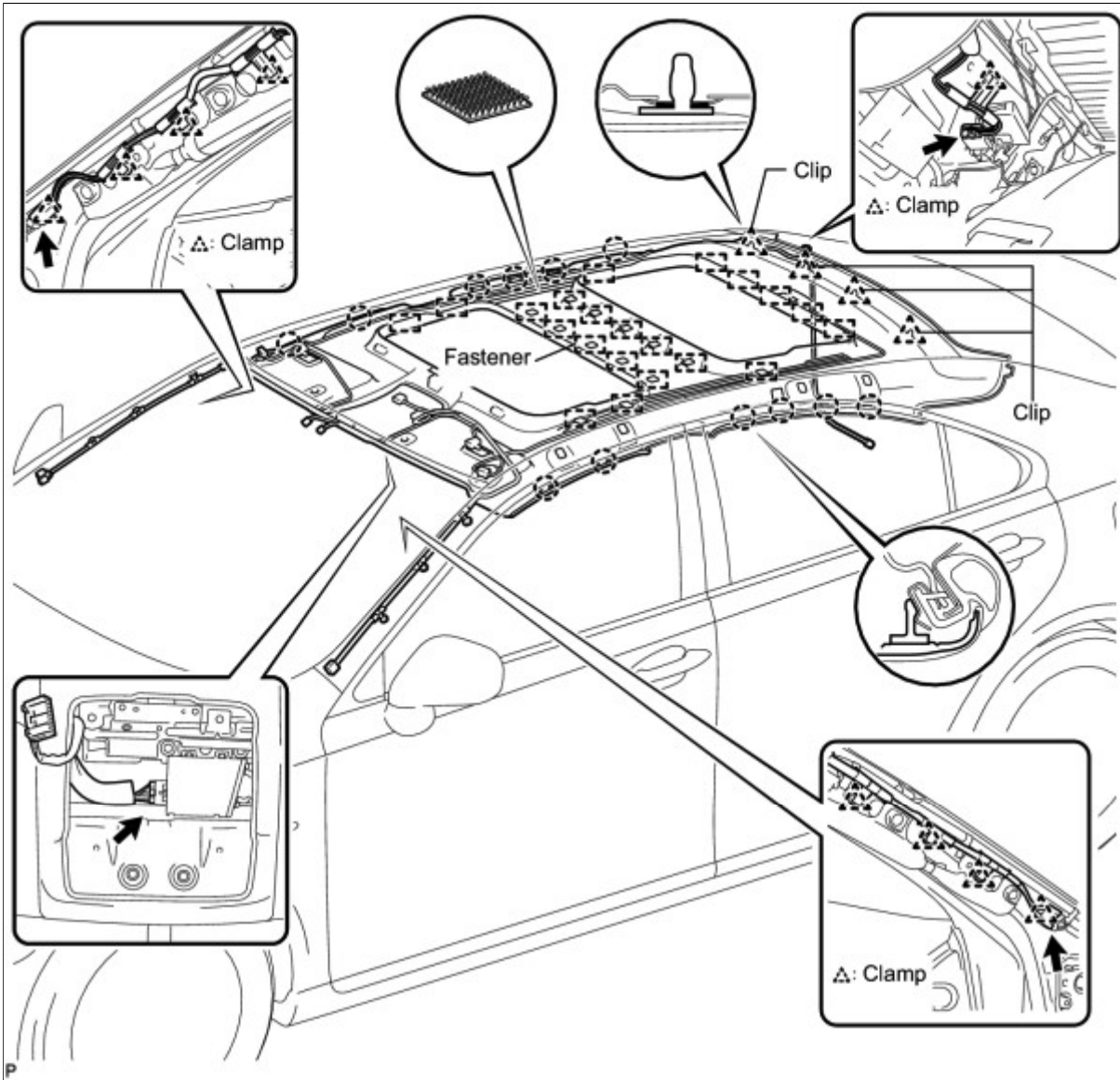

(d) Remove the roof headlining assembly from the vehicle through the front right door.

77. REMOVE ANTENNA CORD SUB-ASSEMBLY

INFO

78. REMOVE VANITY LIGHT ASSEMBLY

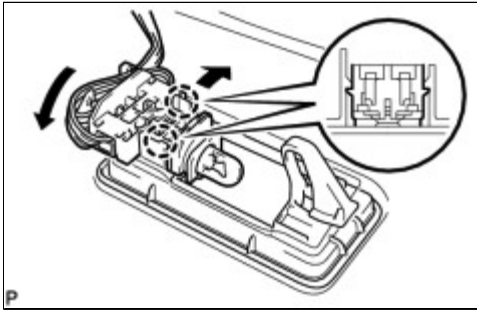

(a) Disengage the 2 claws and separate the bulb holder from the vanity light assembly as shown in the illustration.

(b) Disengage the claw and remove the vanity light assembly.

HINT:

Use the same procedure to remove the light on the other side.

79. REMOVE NO. 1 ROOF WIRE (for Standard)

- (a) Turn the visor connectors clockwise approximately 90° and separate the connectors from the roof headlining assembly.
- (b) Remove the adhesive tape from the roof headlining assembly.
- (c) Remove the No. 1 roof wire from the roof headlining assembly.
- (d) Remove the double-sided tape from the roof headlining assembly.

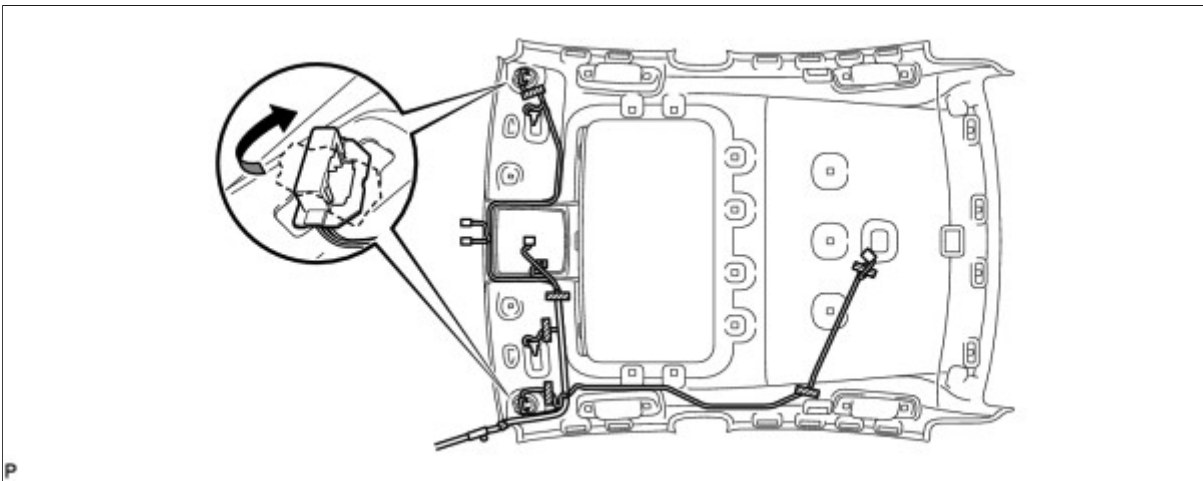

80. REMOVE NO. 1 ROOF WIRE (for Glass Roof)

- (a) Turn the visor connectors clockwise approximately 90° and separate the connectors from the roof headlining assembly.
- (b) Remove the adhesive tape from the roof headlining assembly.
- (c) Remove the No. 1 roof wire from the roof headlining assembly.
- (d) Remove the double-sided tape from the roof headlining assembly.

