

Last Modified: 7-13-2007		1.7 A
Service Category: Vehicle Interior		Section: Interior Panels/Trim
Model Year: 2008	Model: ES350	Doc ID: RM000002DMB002X
Title: INSTRUMENT PANEL: INSTRUMENT PANEL SAFETY PAD: INSTALLATION (2008 ES350)		

INSTALLATION

1. INSTALL NO. 3 INSTRUMENT PANEL STAY

- (a) Engage the 2 claws and install the 2 No. 3 instrument panel stays.

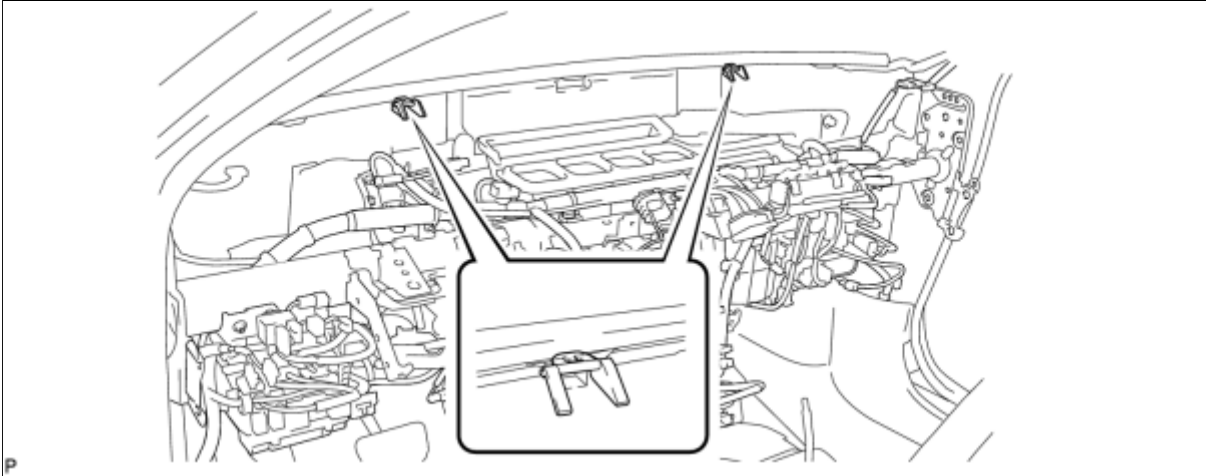

2. INSTALL NO. 1 INSTRUMENT PANEL CLIP

- (a) Engage the 3 claws and install the 3 No. 1 instrument panel clips.

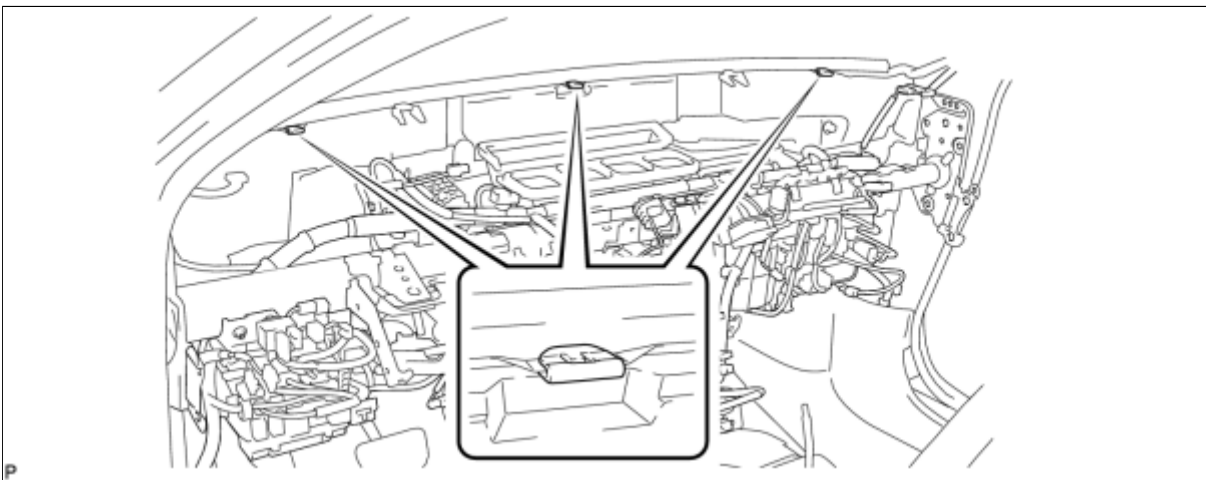

3. INSTALL INSTRUMENT PANEL SAFETY PAD ASSEMBLY (w/o DVD Player)

- (a) Engage the 5 claws.

NOTICE:

Do not allow the wire harness to get caught in the claws.

- (b) Install the 4 clips.
(c) Install the 5 bolts <G> and nut <H>.

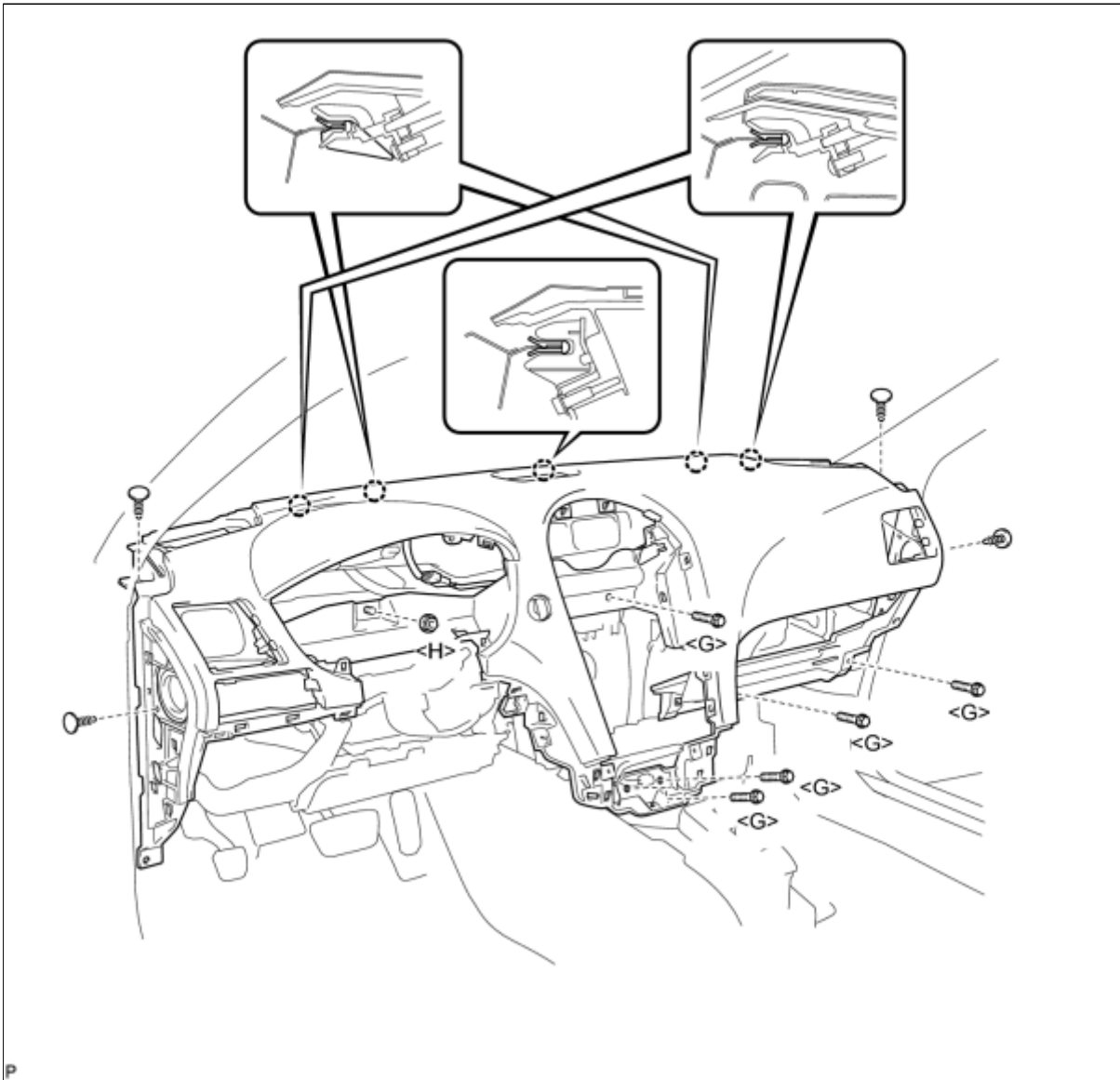

(d) Engage the clip.

(e) Install the bolt <L>.

Torque: 7.0 N·m (71 kgf·cm, 62 in·lbf)

(f) Engage each clamp.

(g) Install the 2 passenger airbag bolts <K>.

Torque: 20 N·m (204 kgf·cm, 15 ft·lbf)

(h) Connect each connector and install the instrument panel safety pad assembly.

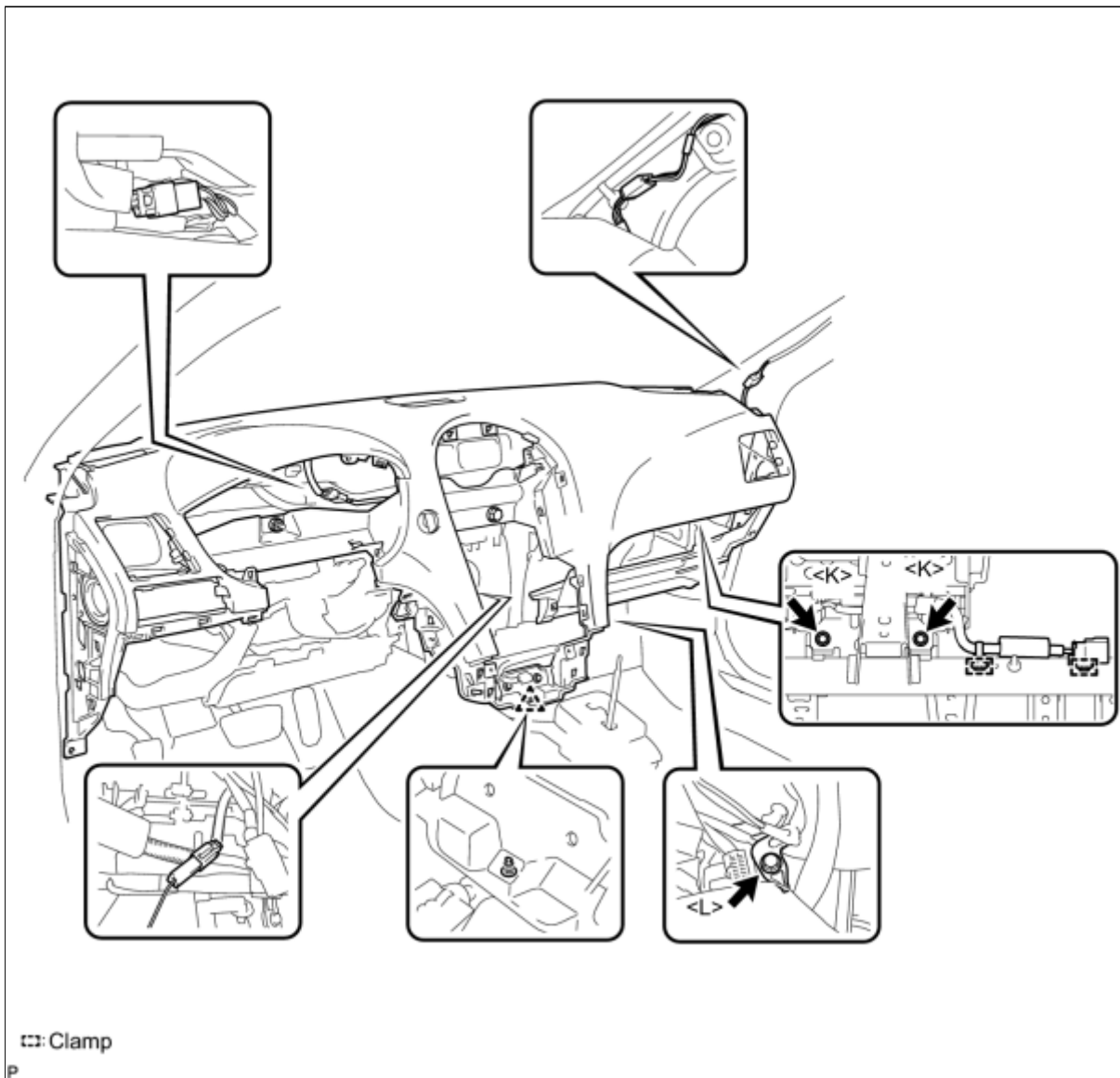

4. INSTALL INSTRUMENT PANEL SAFETY PAD ASSEMBLY (w/ DVD Player)

- (a) Engage the 5 claws.
- (b) Install the 4 clips.
- (c) Install the 5 bolts <G> and nut <H>.

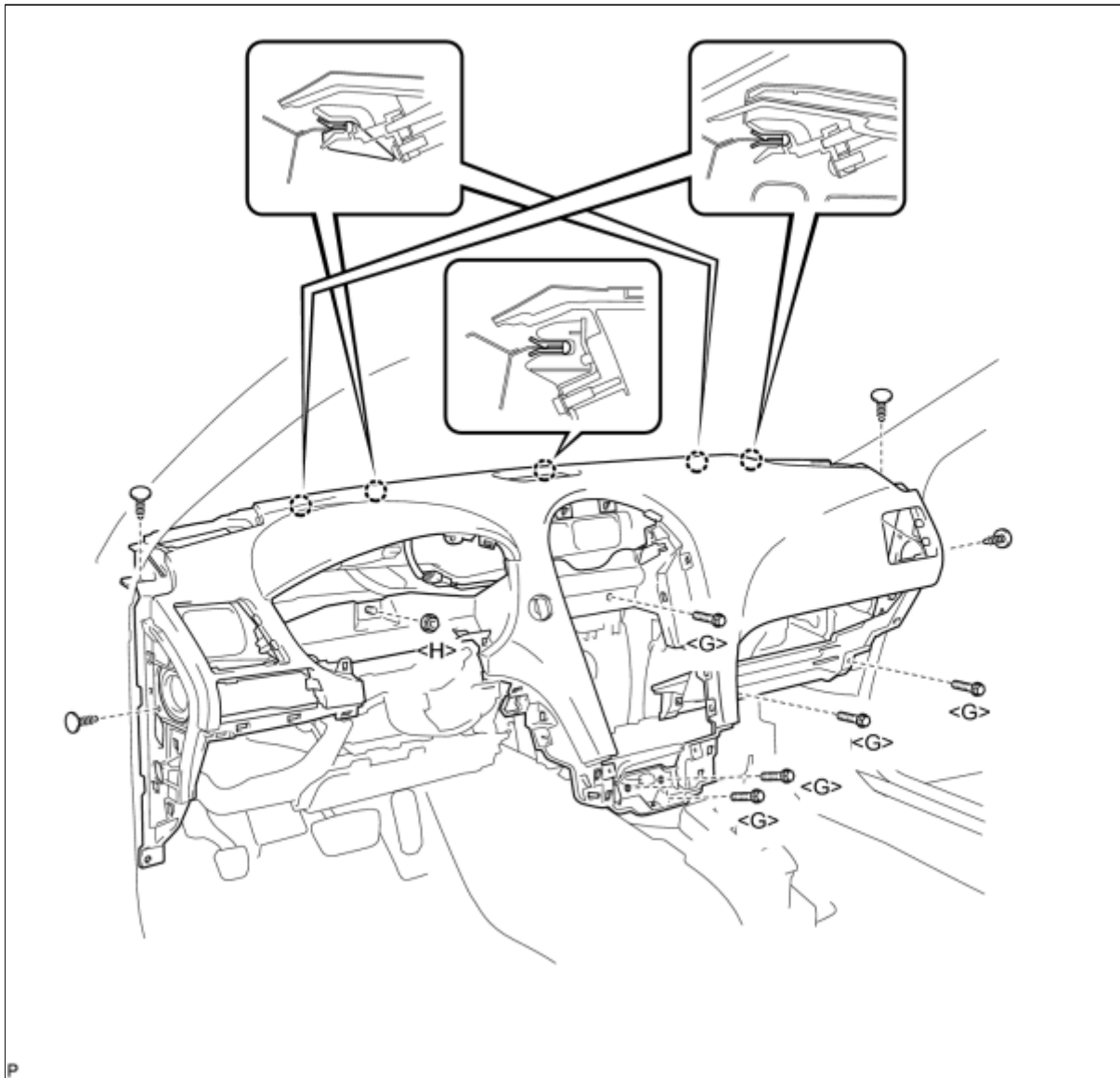

(d) Engage the clip.

(e) Install the bolt <L>.

Torque: 7.0 N·m (71 kgf·cm, 62 in·lbf)

(f) Engage each clamp.

(g) Install the 2 passenger airbag bolts <K>.

Torque: 20 N·m (204 kgf·cm, 15 ft·lbf)

(h) Connect each connector and install the instrument panel safety pad assembly.

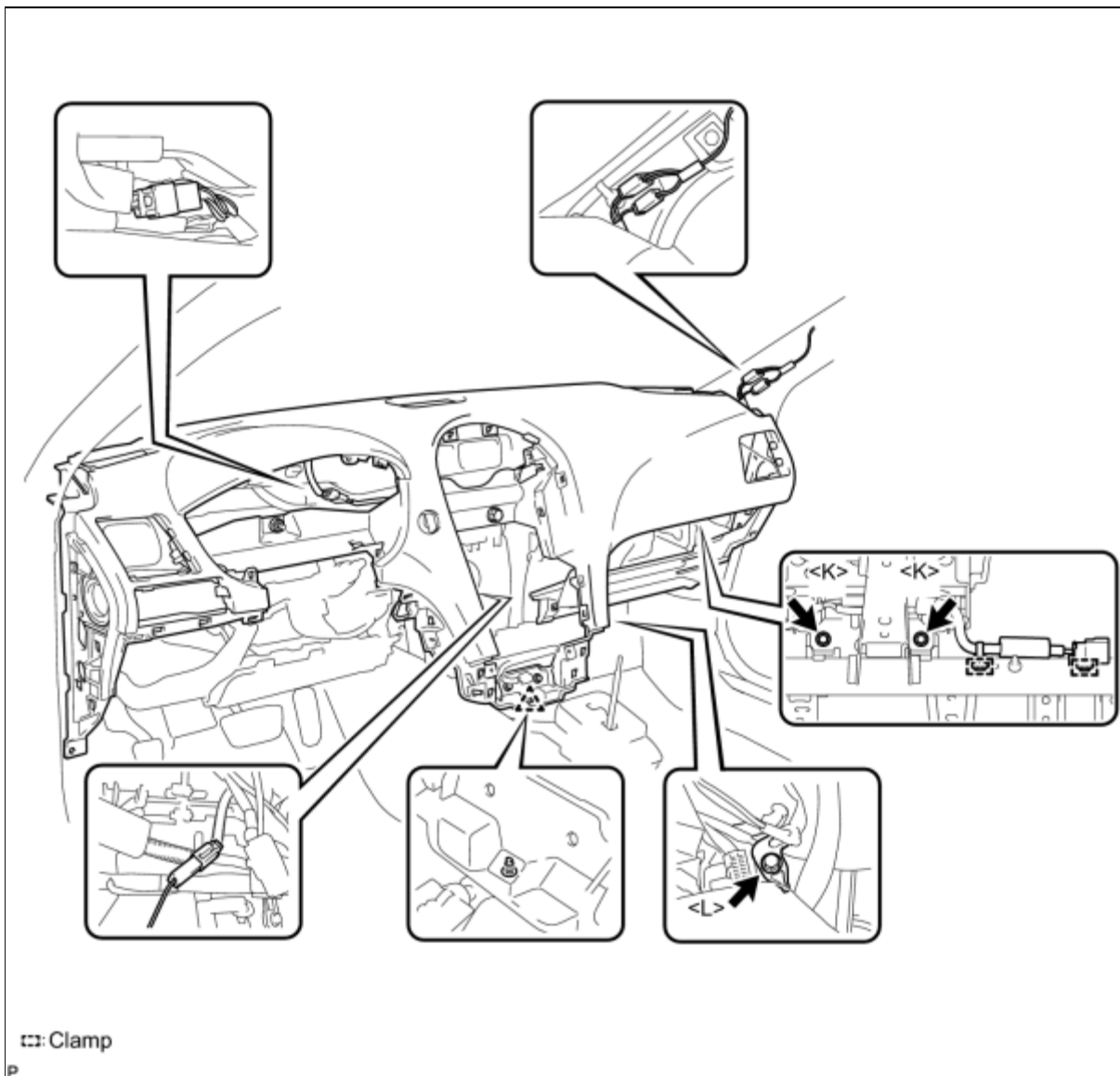

5. INSTALL ROOM TEMPERATURE SENSOR [INFO](#)

6. CONNECT INSTRUMENT PANEL WIRE ASSEMBLY [INFO](#)

7. INSTALL PUSH START SWITCH

(a) Connect the connector.

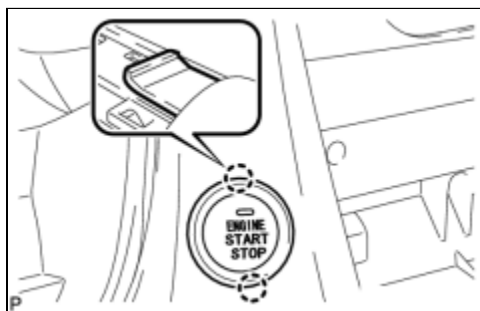

(b) Engage the 2 claws and install the push start switch.

8. INSTALL NO. 1 INSTRUMENT PANEL MOUNTING BRACKET

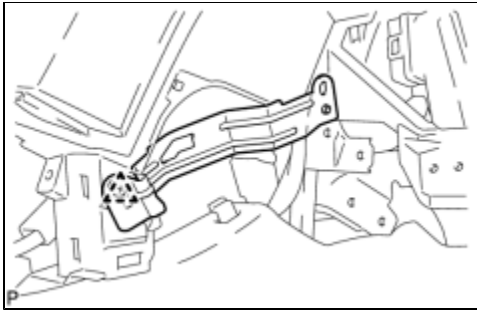

(a) Install the clip and the No. 1 instrument panel mounting bracket.

9. INSTALL FRONT STEREO COMPONENT SPEAKER ASSEMBLY [INFO](#)

10. INSTALL NO. 1 SPEAKER HOLE COVER

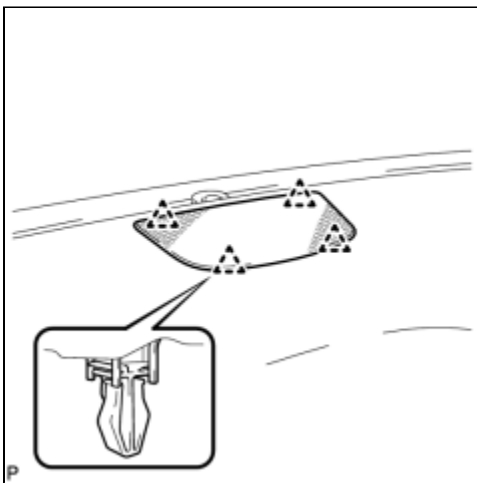

(a) Engage the 4 clips and install the No. 1 speaker hole cover.

11. INSTALL NO. 1 INSTRUMENT PANEL REGISTER ASSEMBLY

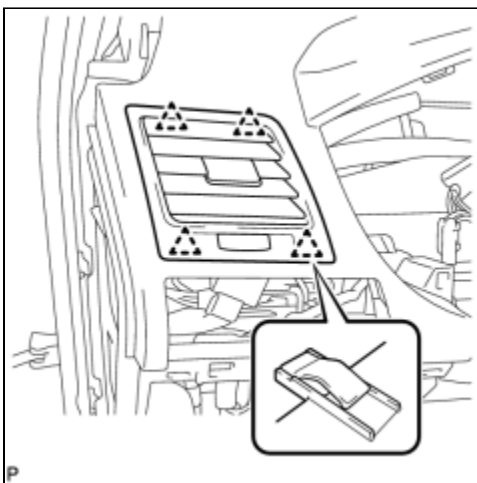

(a) Engage the 4 clips and install the No. 1 instrument panel register assembly.

12. INSTALL FRONT NO. 2 SPEAKER ASSEMBLY (for LH Side) [INFO](#)

13. INSTALL NO. 1 INSTRUMENT PANEL SPEAKER PANEL SUB-ASSEMBLY

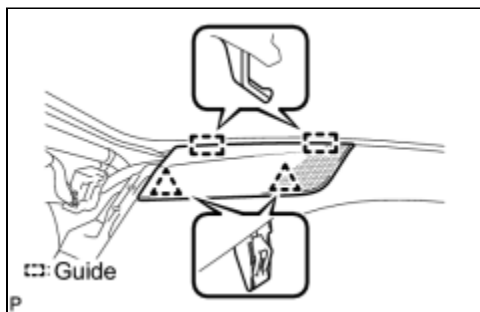

(a) Engage the 2 guides.

(b) Engage the 2 clips and install the No. 1 instrument panel speaker panel sub-assembly.

14. INSTALL FRONT PILLAR GARNISH LH INFO

15. INSTALL NO. 3 INSTRUMENT PANEL REGISTER ASSEMBLY

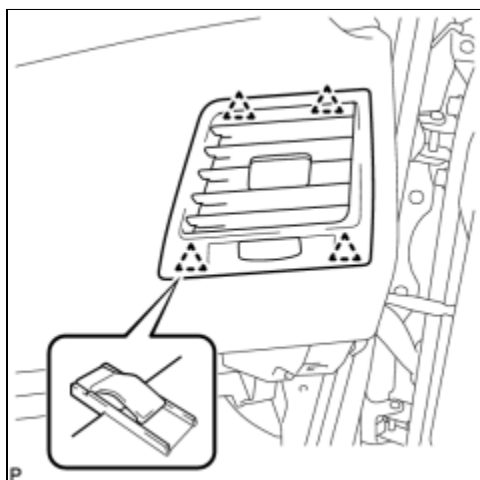

(a) Engage the 4 clips and install the No. 3 instrument panel register assembly.

16. INSTALL FRONT NO. 2 SPEAKER ASSEMBLY (for RH Side)

HINT: Use the same procedures described for the LH side INFO .

17. INSTALL NO. 2 INSTRUMENT PANEL SPEAKER PANEL SUB-ASSEMBLY

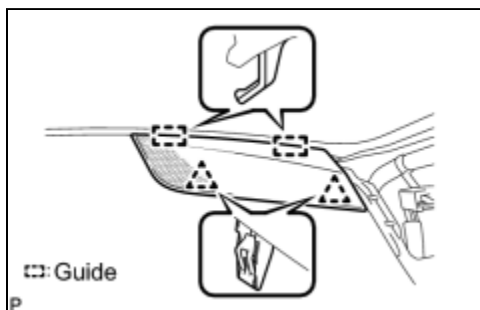

(a) Engage the 2 guides.

(b) Engage the 2 clips and install the No. 2 instrument panel speaker panel sub-assembly.

18. INSTALL FRONT PILLAR GARNISH RH INFO

19. INSTALL REAR CONSOLE BOX ASSEMBLY

(a) Connect each connector.

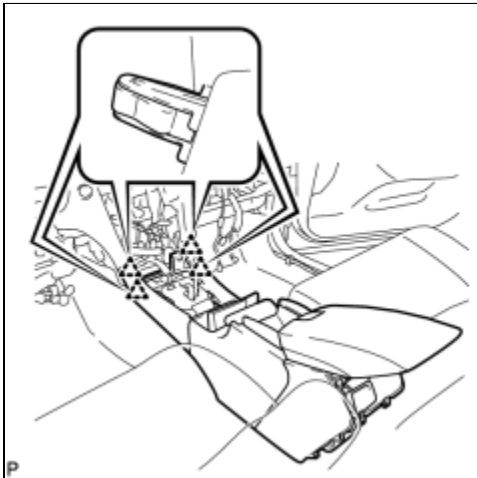

(b) Engage the 4 clips.



(c) Install the 2 screws <F>.

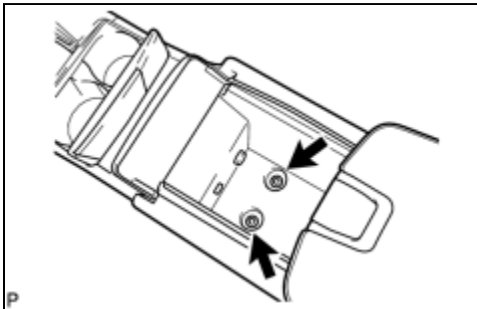

(d) Install the 2 bolts <E>.



(e) Install the rear console box assembly with the 2 bolts <E>.

20. INSTALL CONSOLE REAR END PANEL SUB-ASSEMBLY

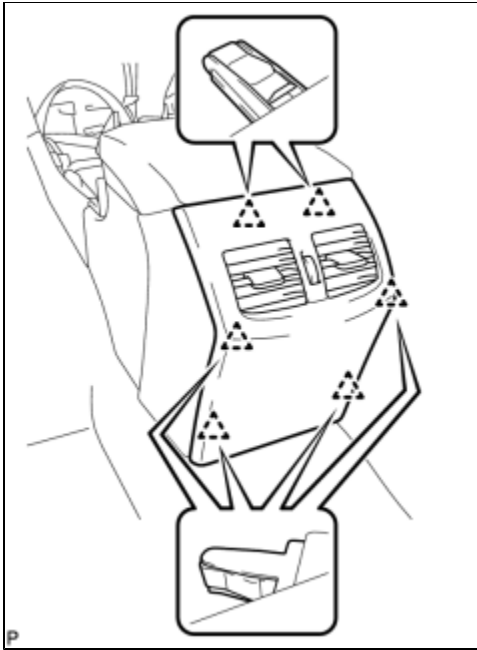

(a) Engage the 6 clips and install the console rear end panel sub-assembly.

21. INSTALL CONSOLE BOX CARPET

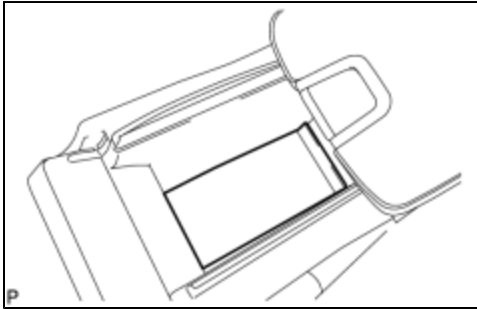

(a) Install the console box carpet.

22. INSTALL CONSOLE BOX POCKET

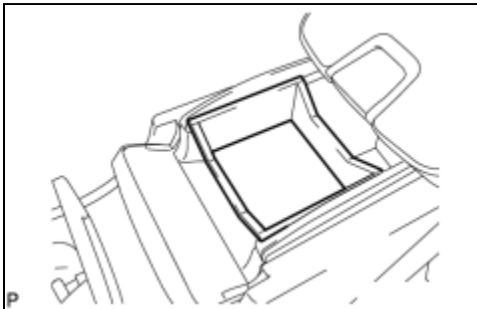

(a) Install the console box pocket.

23. INSTALL HEATER SEAT SWITCH CONSOLE BASE (w/o Seat Heater System)

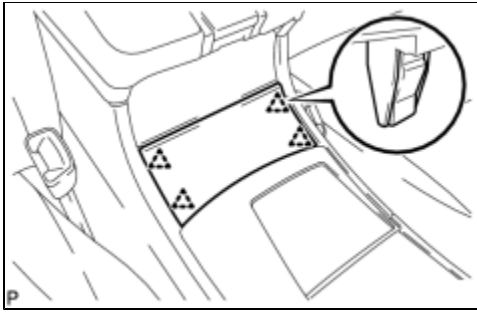

(a) Engage the 4 clips and install the heater seat switch base.

24. INSTALL HEATER SEAT SWITCH CONSOLE BASE (w/ Seat Heater System)

(a) Connect each connector.

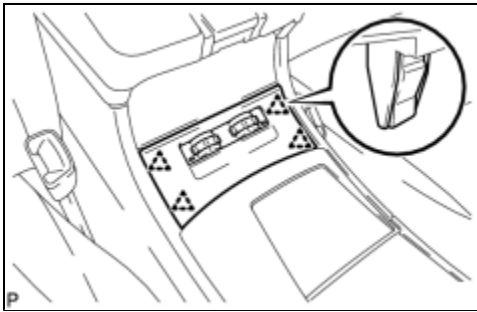

(b) Engage the 4 clips and install the heater seat switch base.

25. INSTALL INTEGRATION CONTROL PANEL WITH RADIO RECEIVER ASSEMBLY (w/o Navigation System) [INFO](#)

26. INSTALL MULTI-DISPLAY WITH RADIO RECEIVER ASSEMBLY (w/ Navigation System) [INFO](#)

27. INSTALL NO. 2 INSTRUMENT PANEL REGISTER ASSEMBLY

(a) Connect the connector.

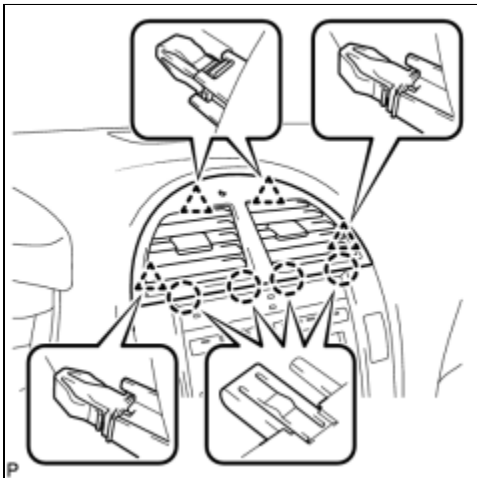

(b) Engage the 4 claws and 4 clips, and install the No. 2 instrument panel register assembly.

28. INSTALL UPPER CONSOLE PANEL ASSEMBLY WITH FRONT ASH RECEPTACLE

(a) Connect the connector.

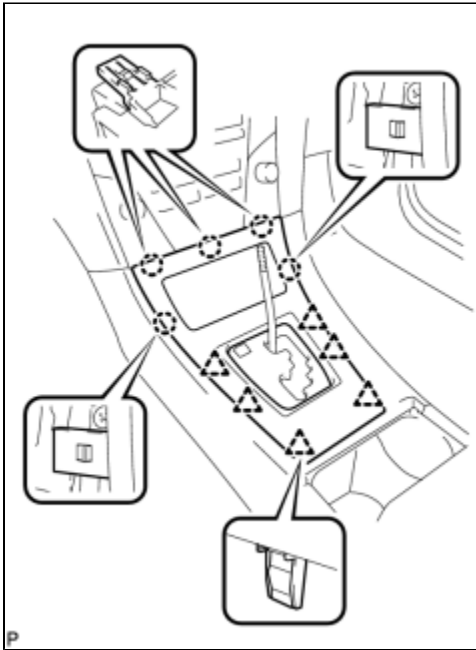

(b) Engage the 5 claws and 6 clips to install the upper console panel assembly with front ash receptacle.

29. INSTALL SHIFT LEVER KNOB SUB-ASSEMBLY

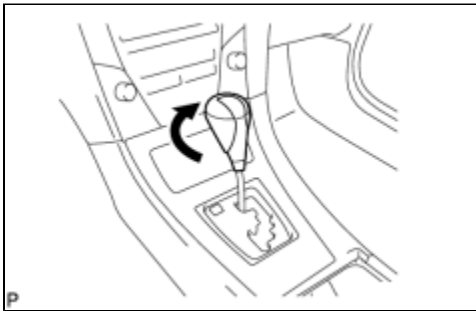

(a) Install the shift lever knob sub-assembly.

30. INSTALL LOWER INSTRUMENT PANEL RH

(a) Connect each connector.

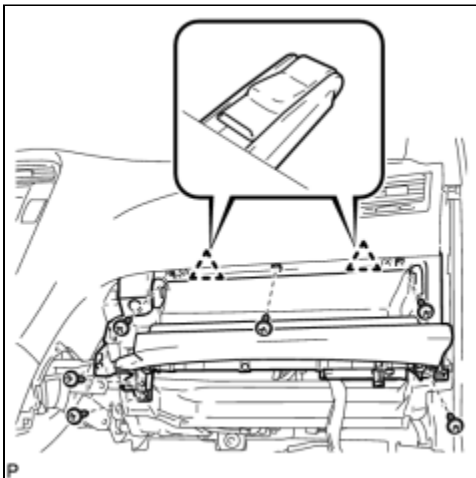

(b) Engage the 2 clips.

(c) Install the lower instrument panel RH with the 6 screws <D>.

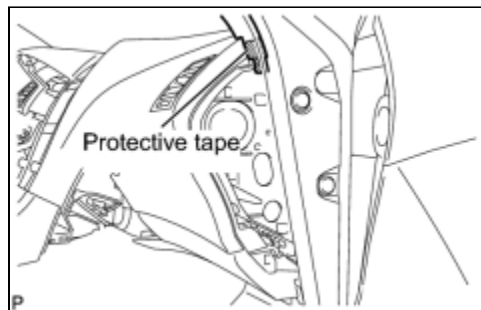
31. INSTALL FRONT PASSENGER SIDE KNEE AIRBAG ASSEMBLY INFO**32. INSTALL SIDE INSTRUMENT PANEL RH**

(a) Apply protective tape to the area shown in the illustration.

(b) Engage the upper end of the side instrument panel RH with the lower end of the front pillar garnish RH as shown in the illustration.

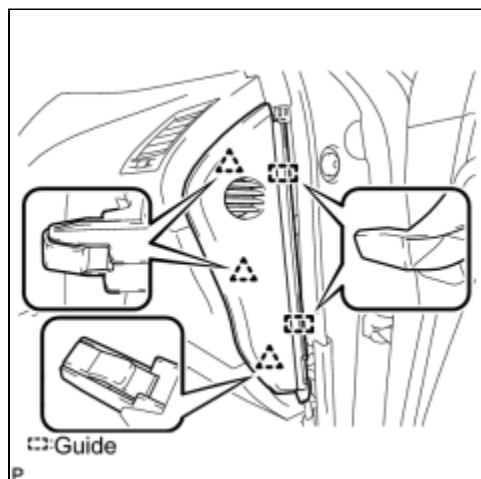
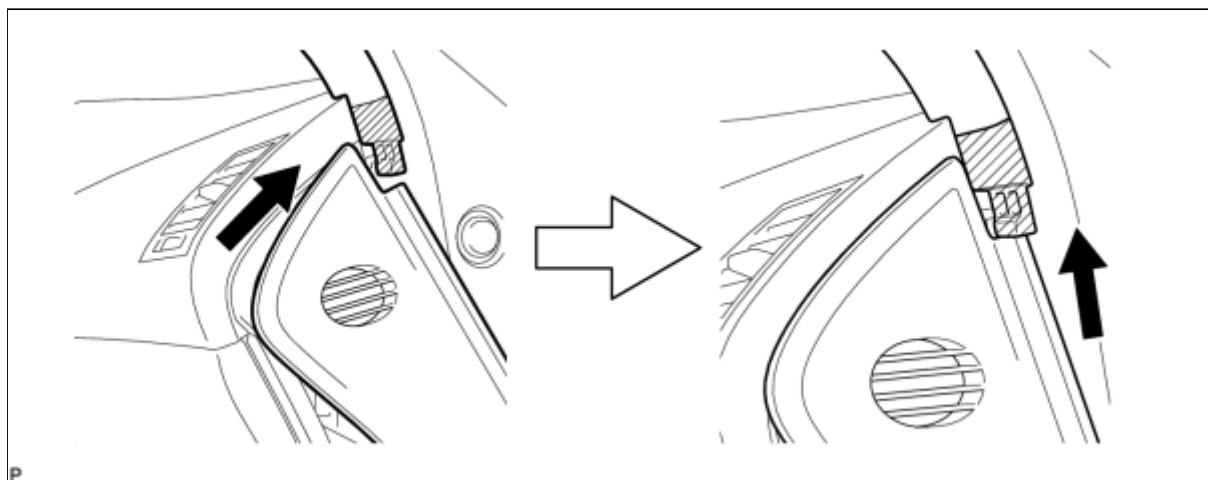

(c) Engage the 2 guides and the 3 clips to install the side instrument panel RH.

33. INSTALL NO. 2 INSTRUMENT PANEL UNDER COVER SUB-ASSEMBLY

(a) Connect the connector.

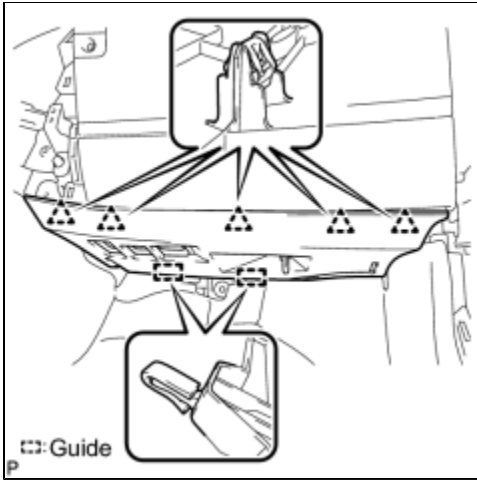

(b) Engage the 2 guides.

(c) Engage the 5 clips and install the No. 2 instrument panel under cover sub-assembly.

34. INSTALL FRONT DOOR OPENING TRIM COVER RH INFO

35. INSTALL FRONT DOOR SCUFF PLATE RH INFO

36. INSTALL INSTRUMENT PANEL FINISH PANEL END RH

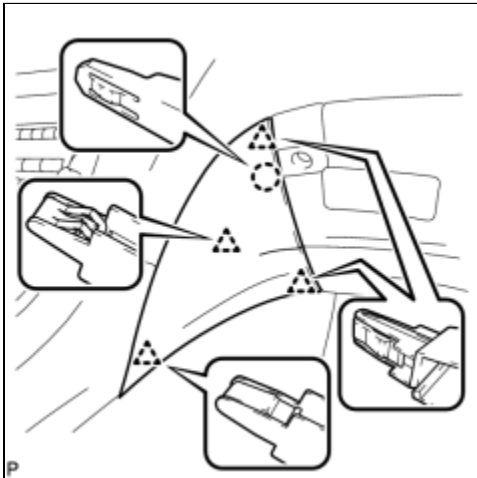

(a) Engage the claw and 4 clips to install the instrument panel finish panel end RH.

37. INSTALL NO. 1 SWITCH HOLE BASE

(a) Connect each connector.

(b) Engage the 4 clips and install the No. 1 switch hole base.



38. INSTALL COMBINATION METER ASSEMBLY

(a) Connect each connector.

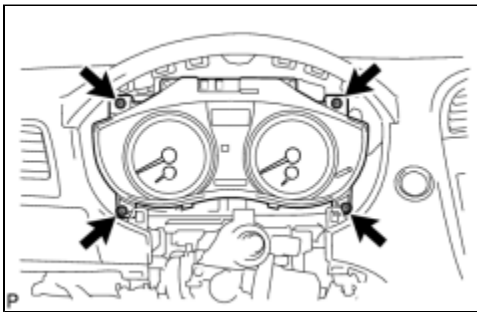

(b) Install the combination meter assembly with the 4 screws or <C>.

39. INSTALL INSTRUMENT CLUSTER FINISH PANEL SUB-ASSEMBLY

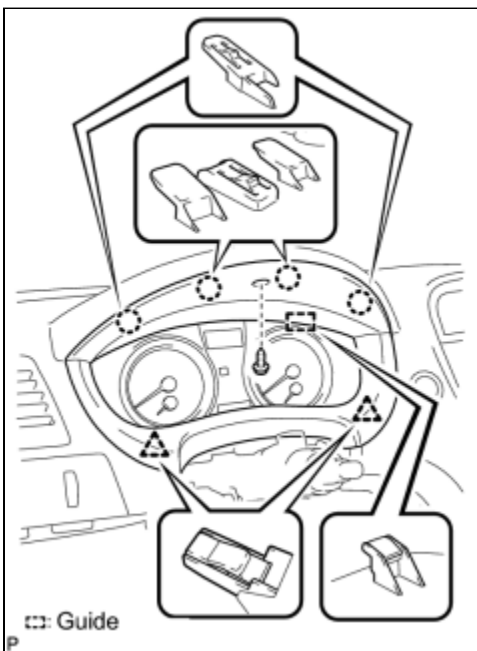

(a) Engage the guide and the 4 claws.

(b) Engage the 2 clips.

(c) Install the instrument cluster finish panel sub-assembly with the screw .

40. INSTALL TURN SIGNAL SWITCH ASSEMBLY WITH SPIRAL CABLE SUB-ASSEMBLY INFO

41. INSTALL TILT AND TELESCOPIC SWITCH INFO

42. INSTALL STEERING COLUMN COVER

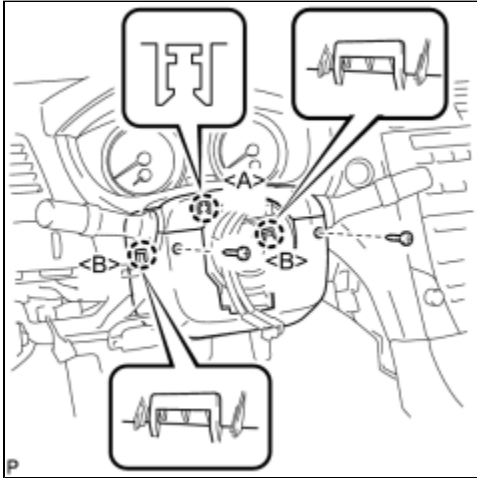

(a) Engage the claw <A> and install the upper steering column cover.

(b) Engage the 2 claws and install the lower steering column cover.

(c) Install the 2 screws <J>.

Torque: 2.0 N·m (20 kgf·cm, 18 in·lbf)

43. ADJUST SPIRAL CABLE SUB-ASSEMBLY INFO

44. INSTALL LOWER INSTRUMENT PANEL SUB-ASSEMBLY

(a) Connect each connector.

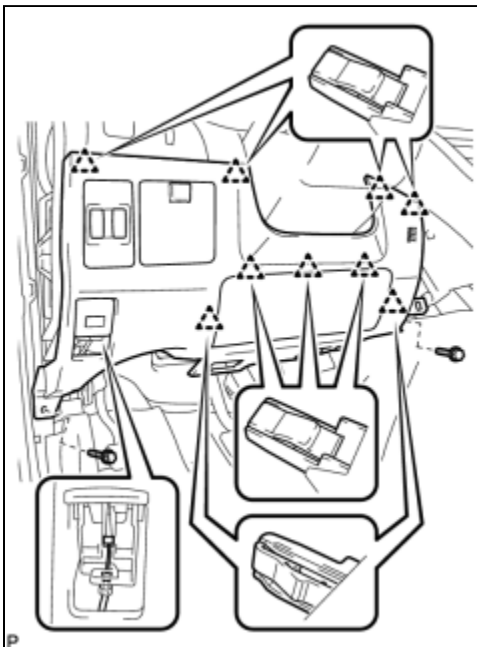

(b) Engage the 9 clips.

(c) Connect the hood lock control cable assembly.

(d) Install the lower instrument panel sub-assembly with the 2 bolts <A>.

45. INSTALL INSTRUMENT PANEL FINISH PANEL END LH

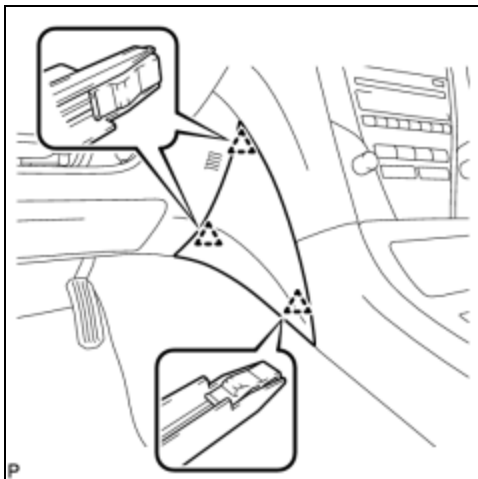

(a) Engage the 3 clips and install the instrument panel finish panel end LH.

46. INSTALL SIDE INSTRUMENT PANEL LH

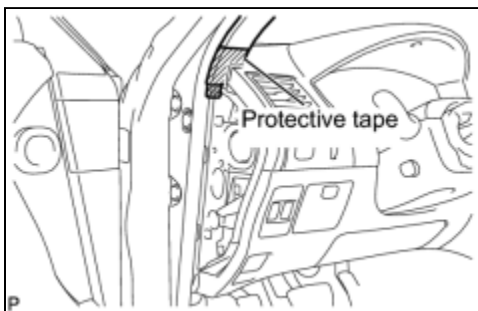

(a) Apply protective tape to the area shown in the illustration.

(b) Engage the upper end of the side instrument panel LH with the lower end of the front pillar garnish LH as shown in the illustration.



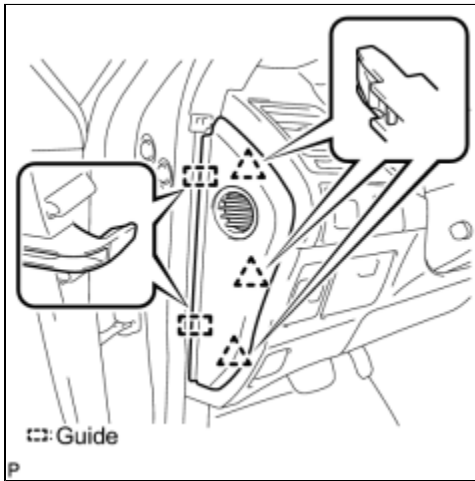

(c) Engage the 2 guides and the 3 clips to install the side instrument panel LH.

47. INSTALL FRONT DOOR OPENING TRIM COVER LH [INFO](#)

48. INSTALL FRONT DOOR SCUFF PLATE LH [INFO](#)

49. INSTALL STEERING WHEEL ASSEMBLY [INFO](#)

50. INSTALL STEERING PAD [INFO](#)

51. INSTALL LOWER NO. 3 STEERING WHEEL COVER [INFO](#)

52. INSTALL LOWER NO. 2 STEERING WHEEL COVER [INFO](#)

53. CONNECT CABLE TO NEGATIVE BATTERY TERMINAL

54. INSPECT STEERING PAD [INFO](#)

55. INSPECT FRONT PASSENGER SIDE KNEE AIRBAG ASSEMBLY [INFO](#)

56. INSPECT SRS WARNING LIGHT [INFO](#)

57. PERFORM INITIALIZATION

NOTICE:

Some systems need initialization after reconnecting the cable to the negative battery terminal [INFO](#) .

