

# Engine Control

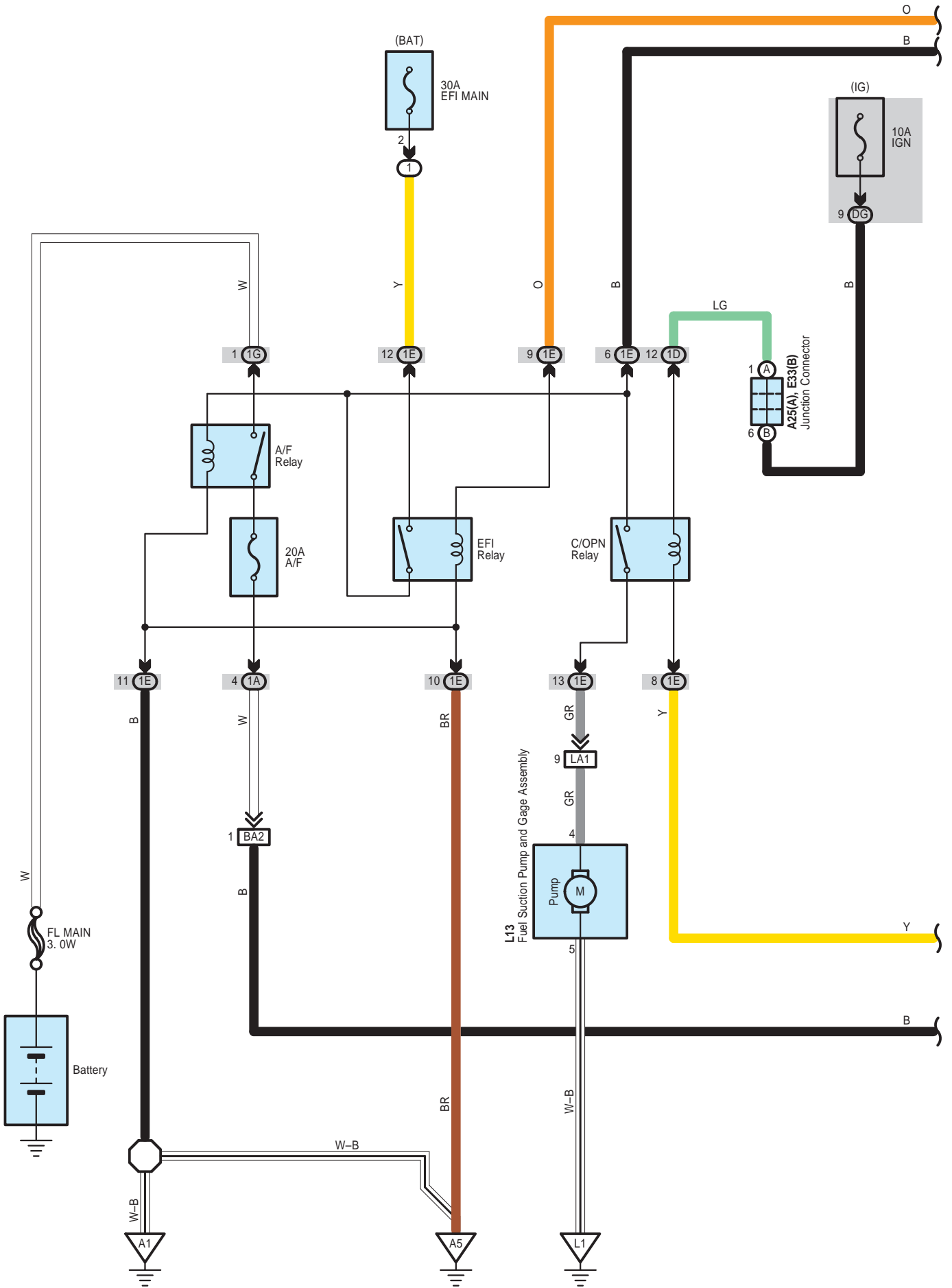

# Engine Control

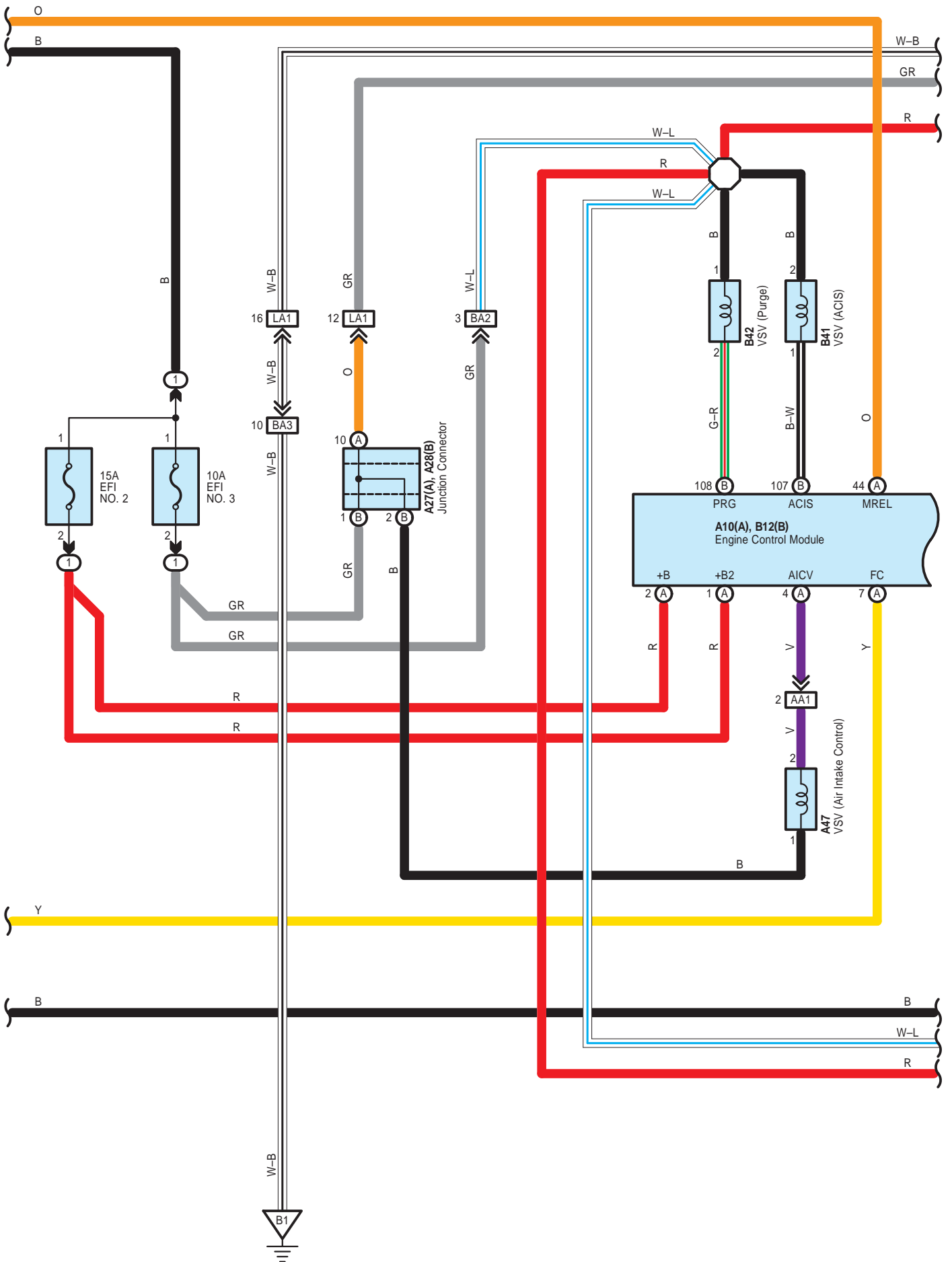

# Engine Control

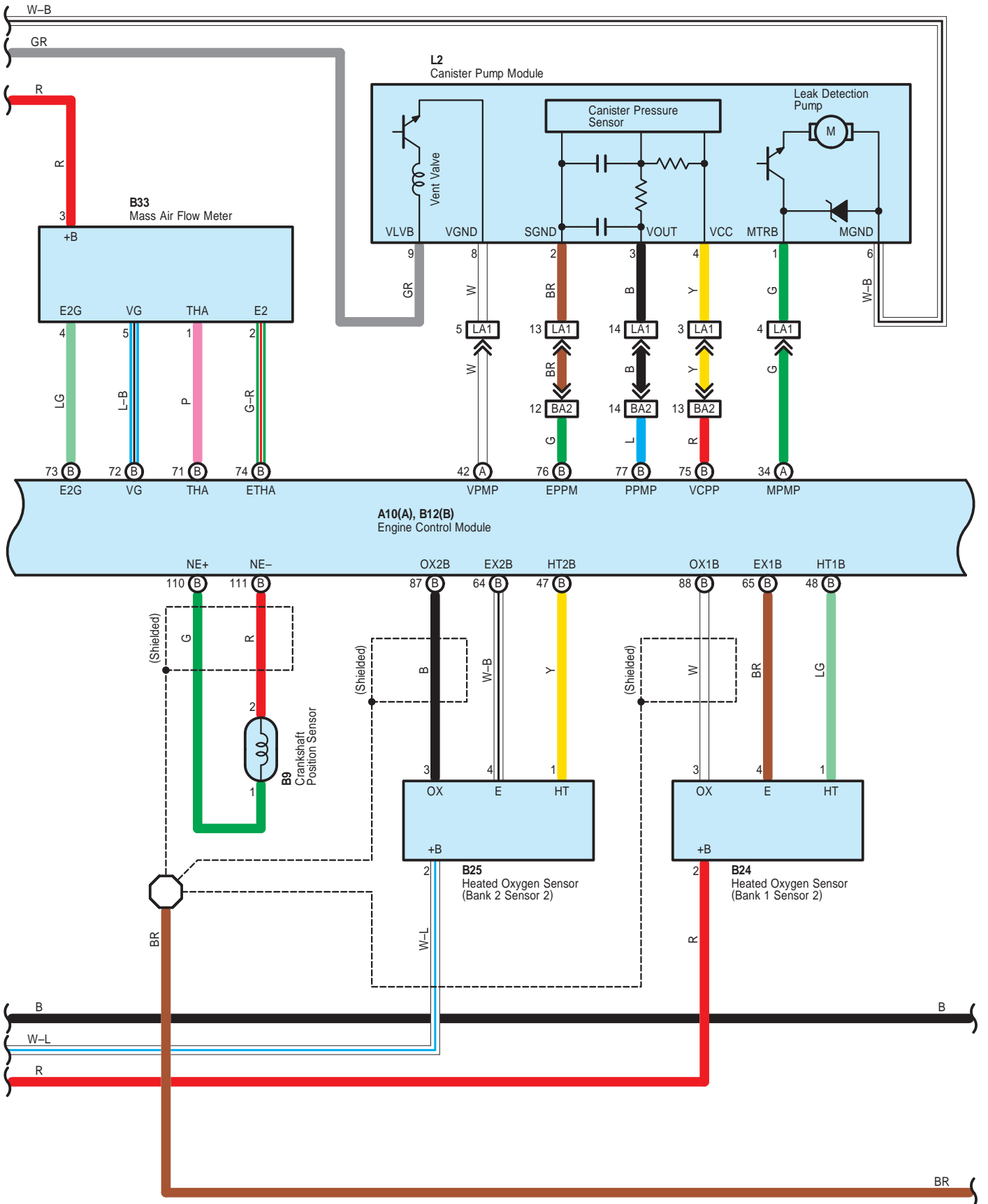

# Engine Control

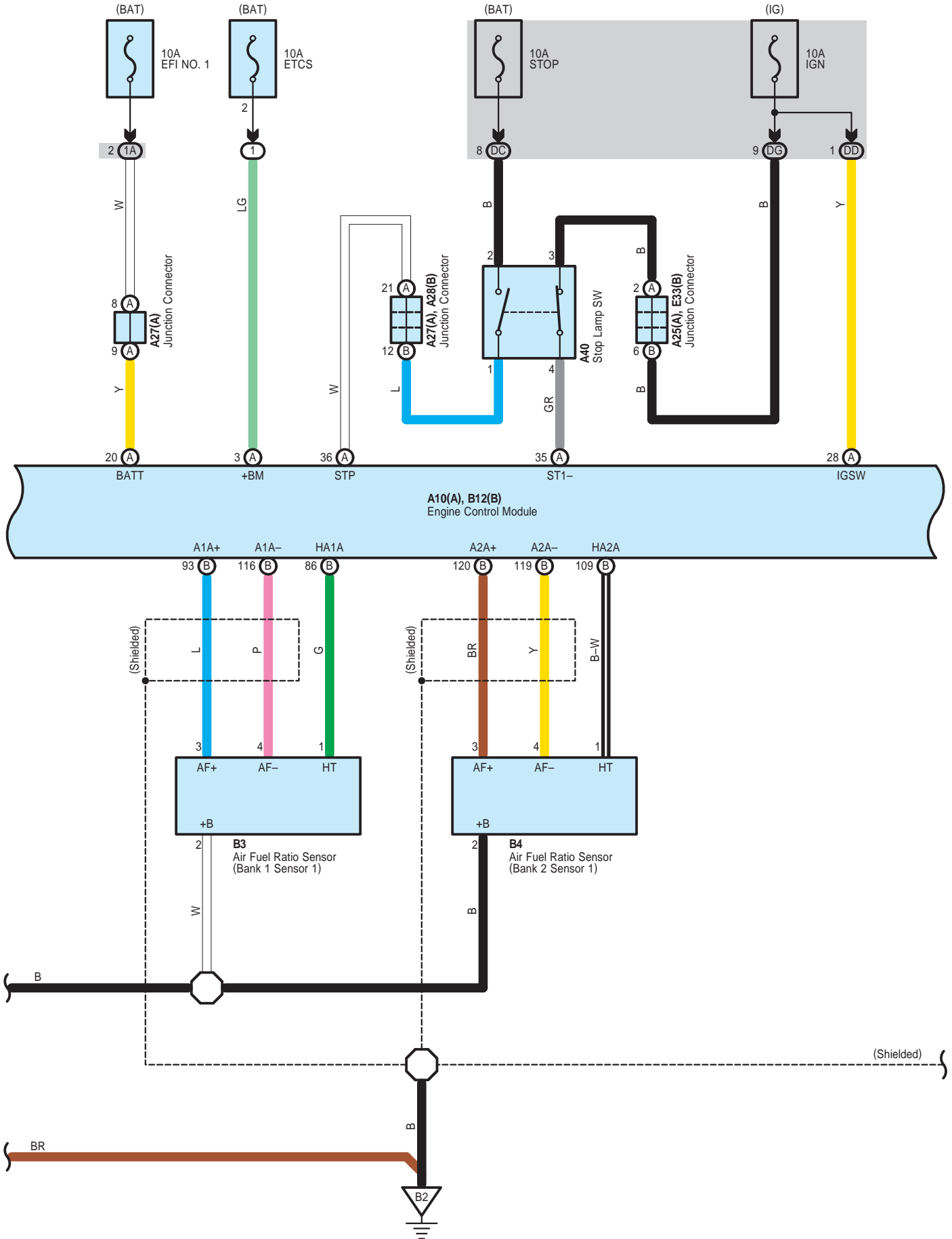

# Engine Control

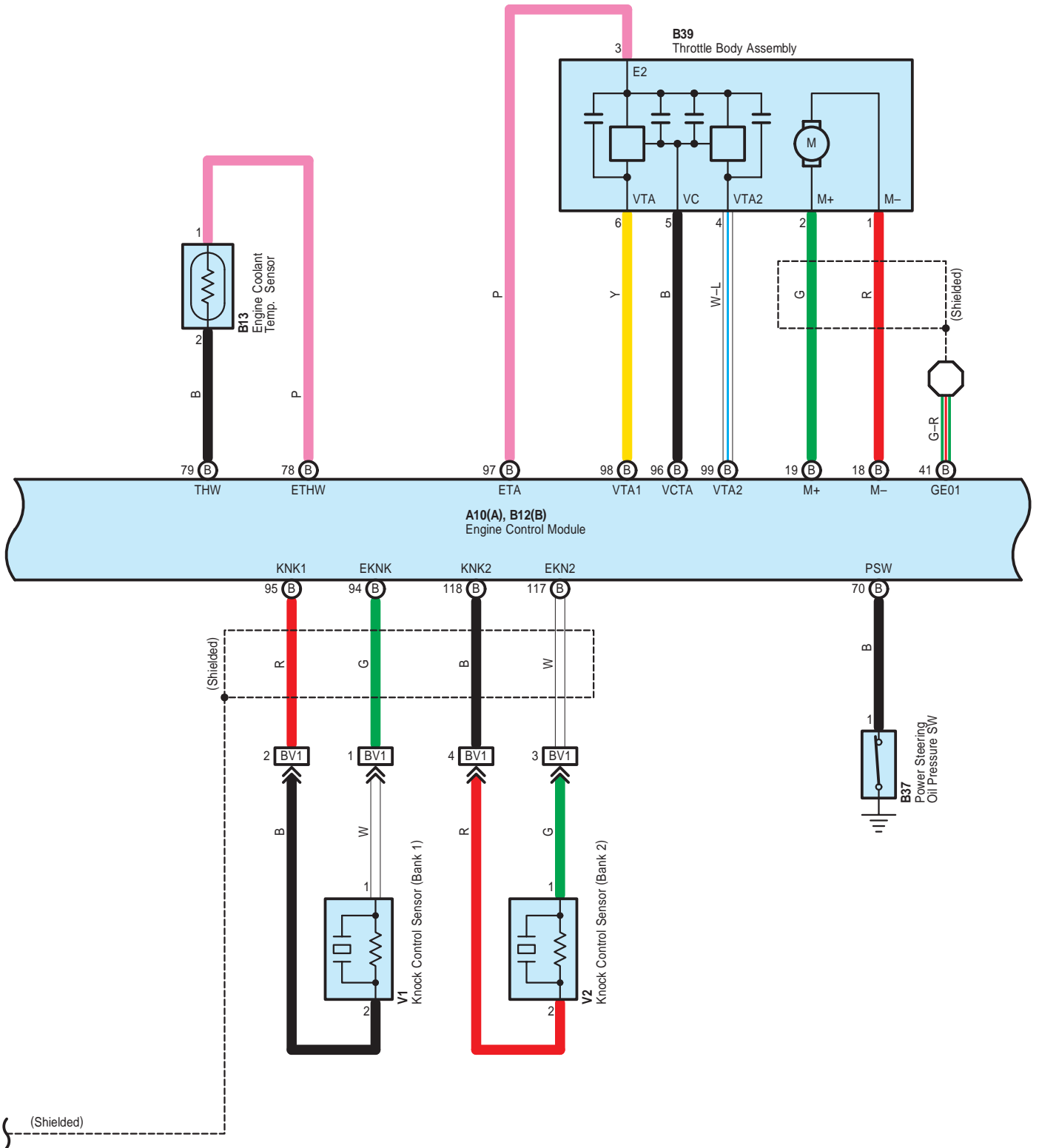

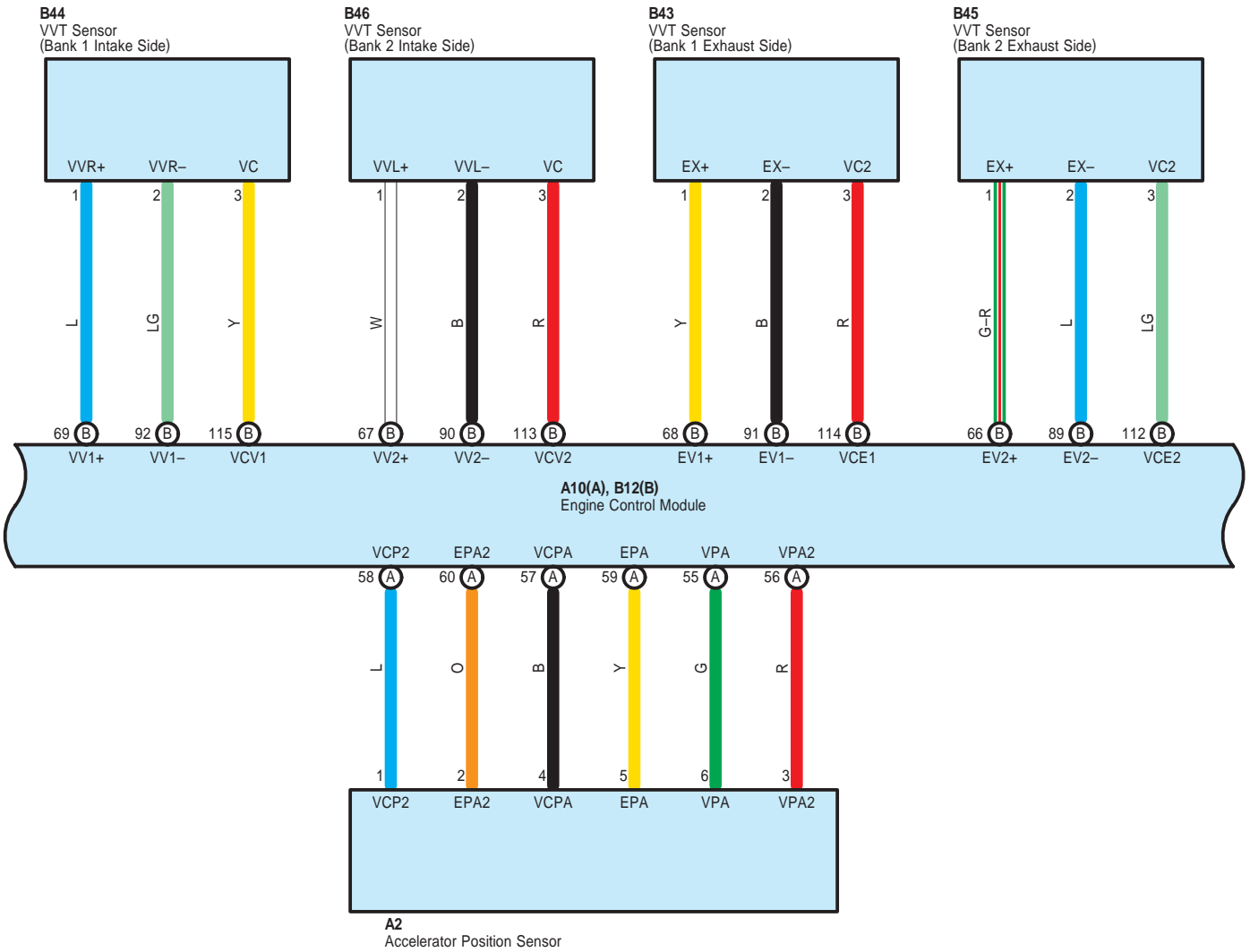

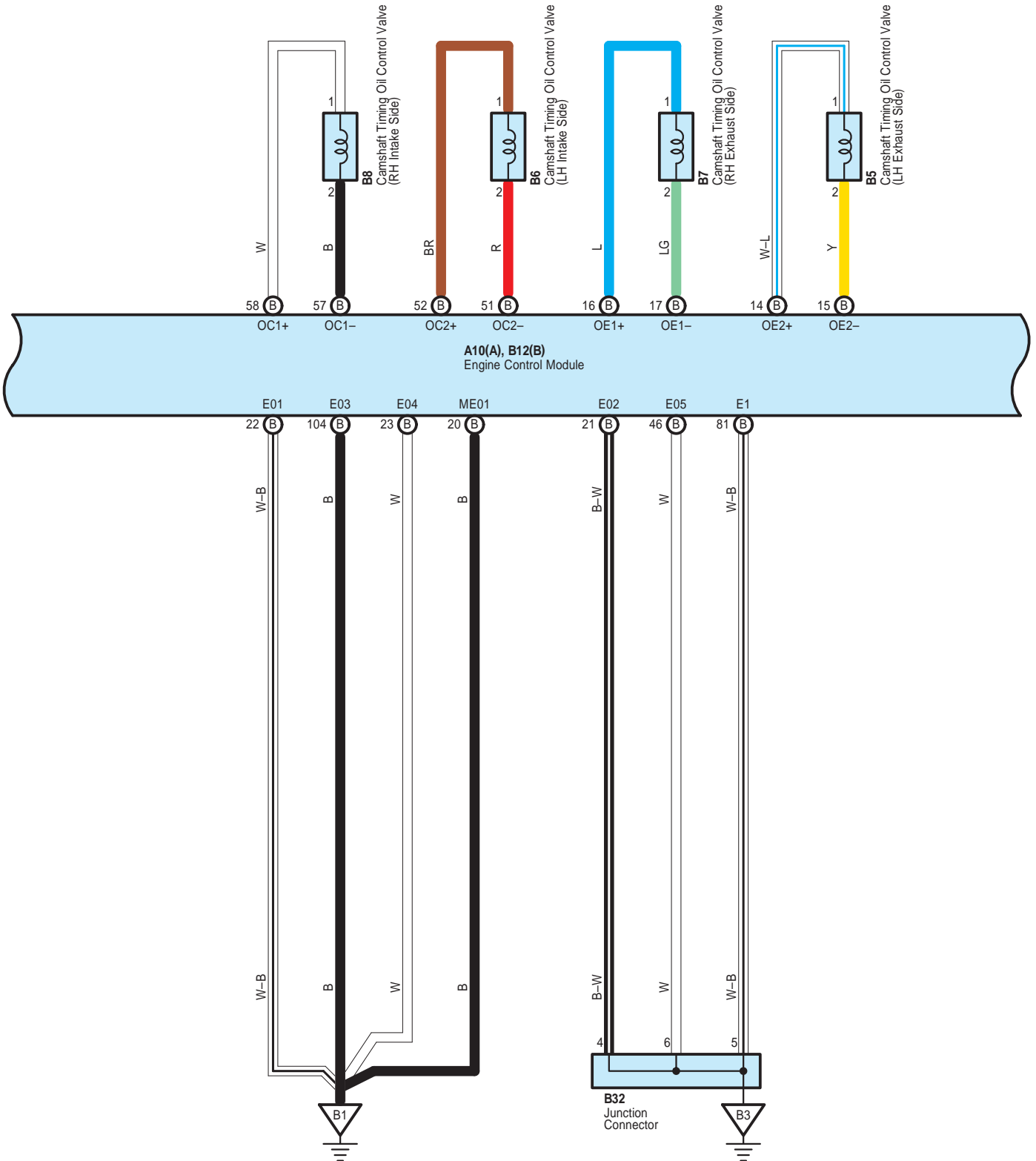

# Engine Control

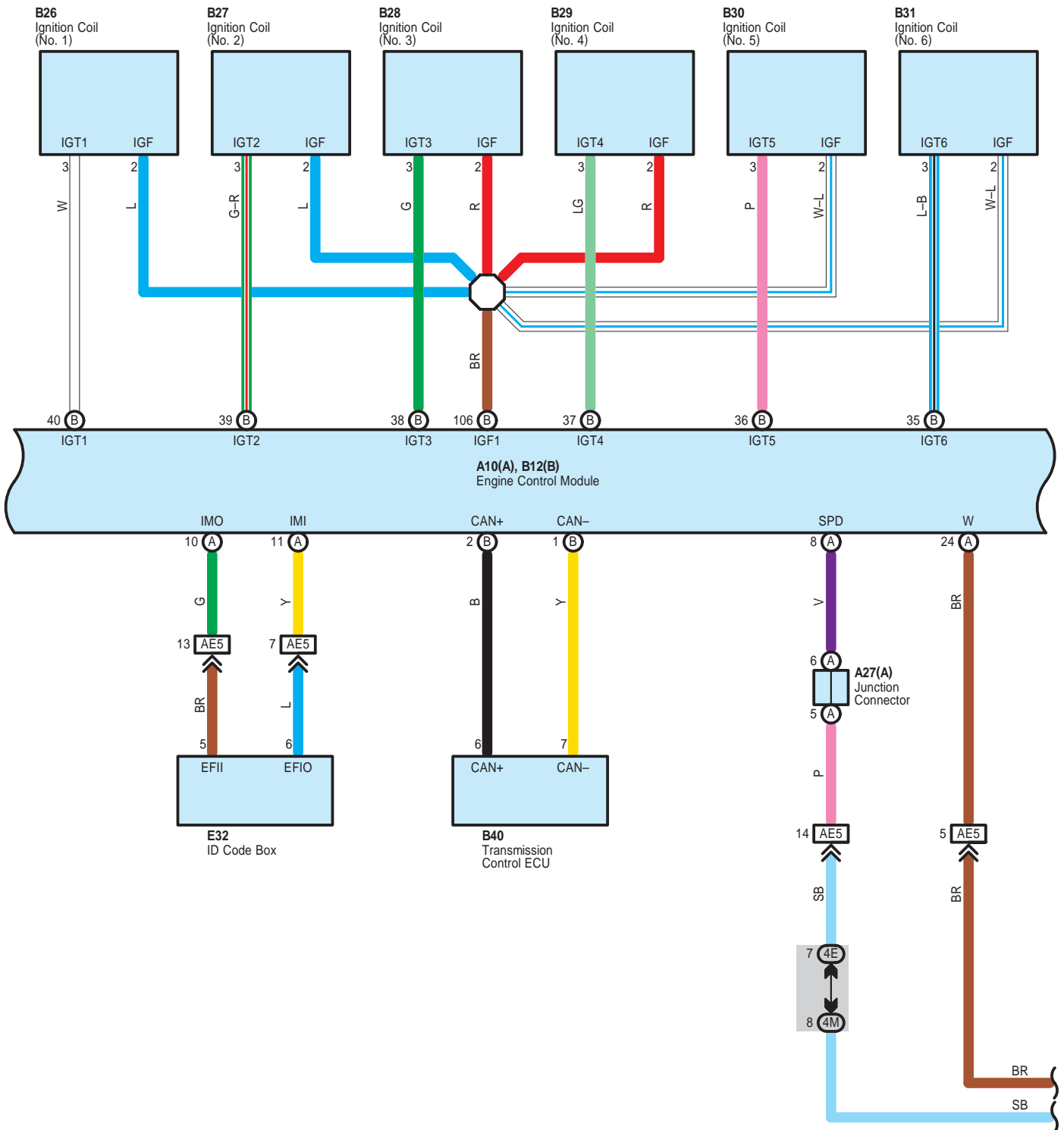



# Engine Control

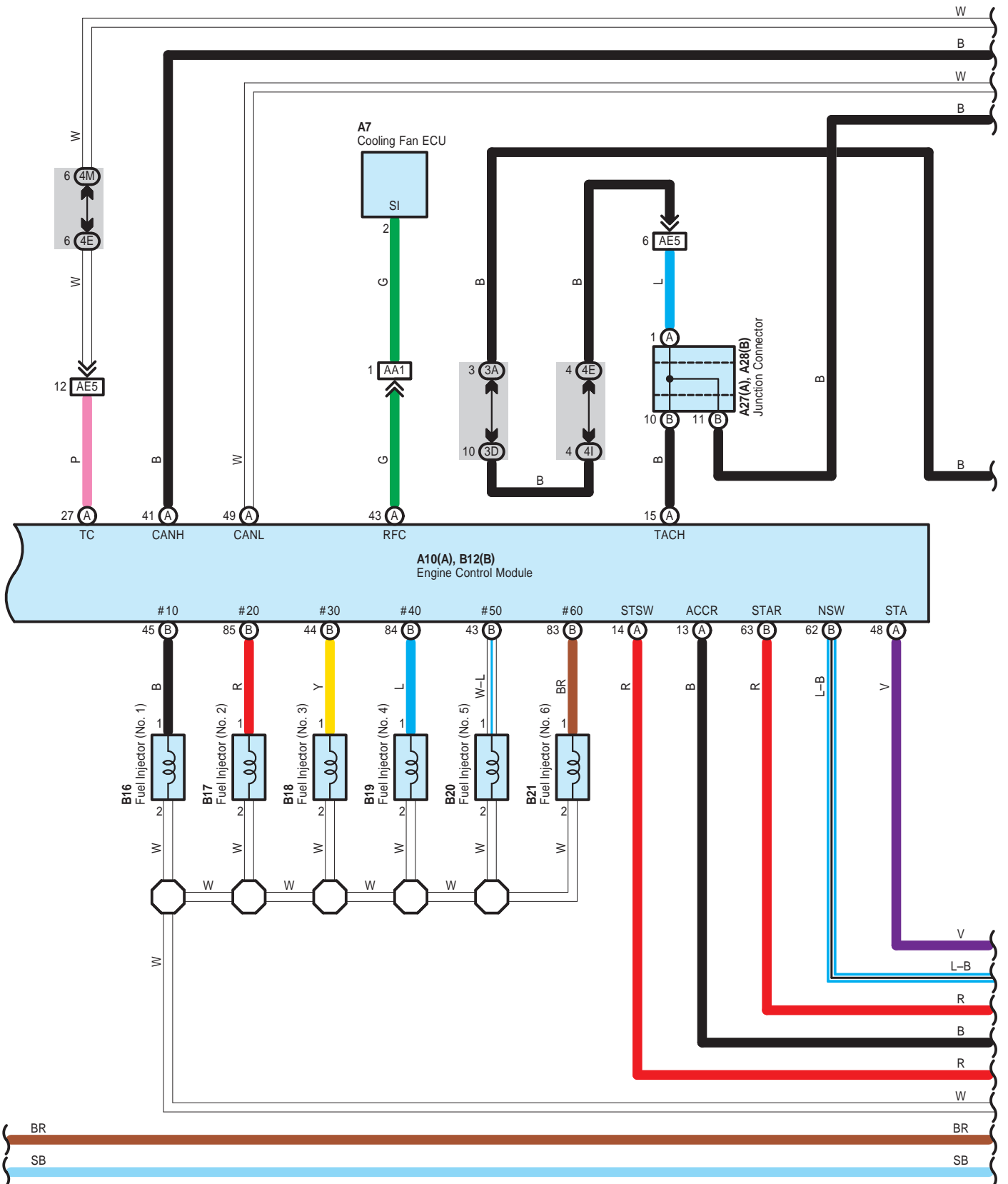

# Engine Control

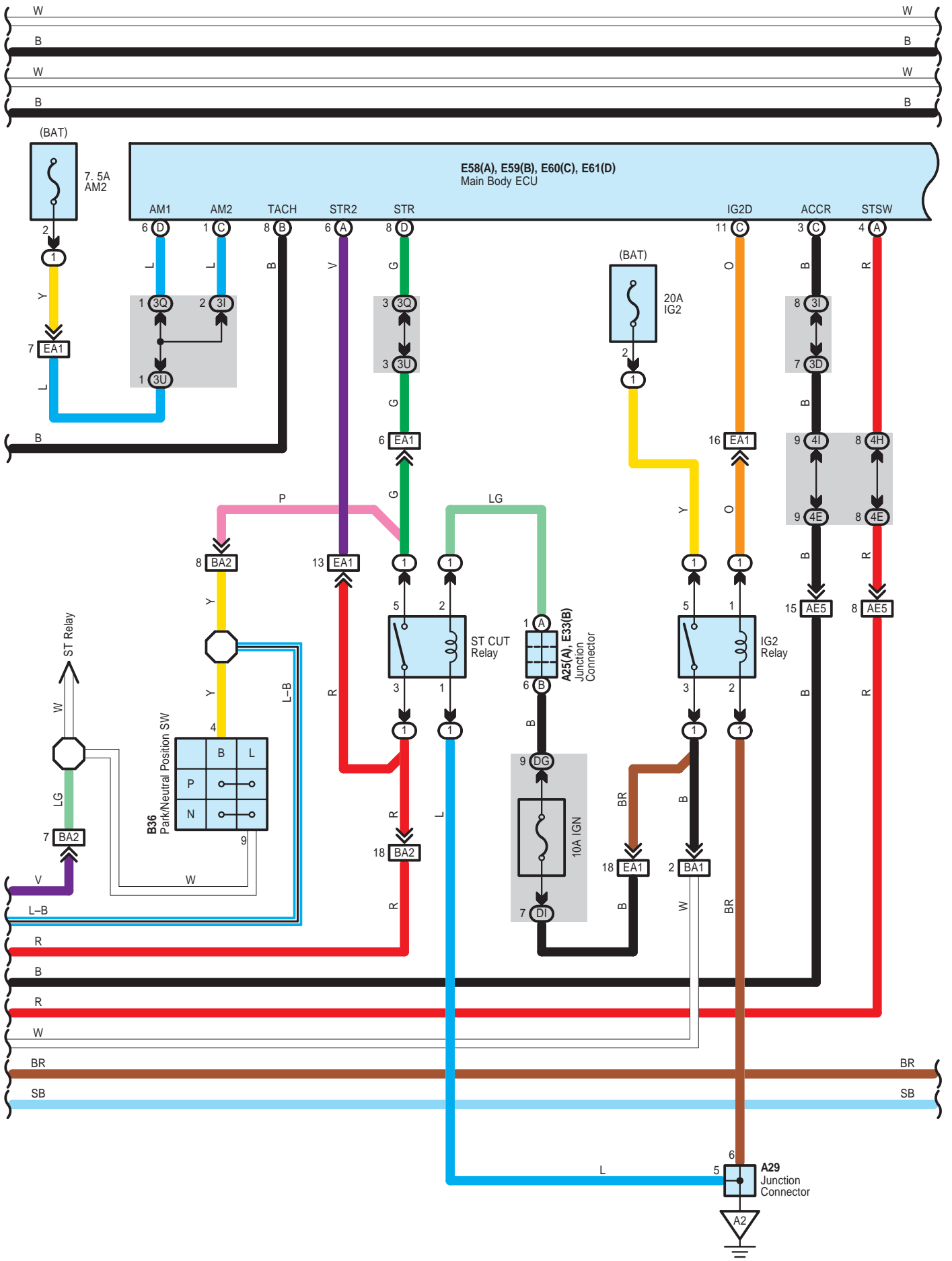

Engine Control

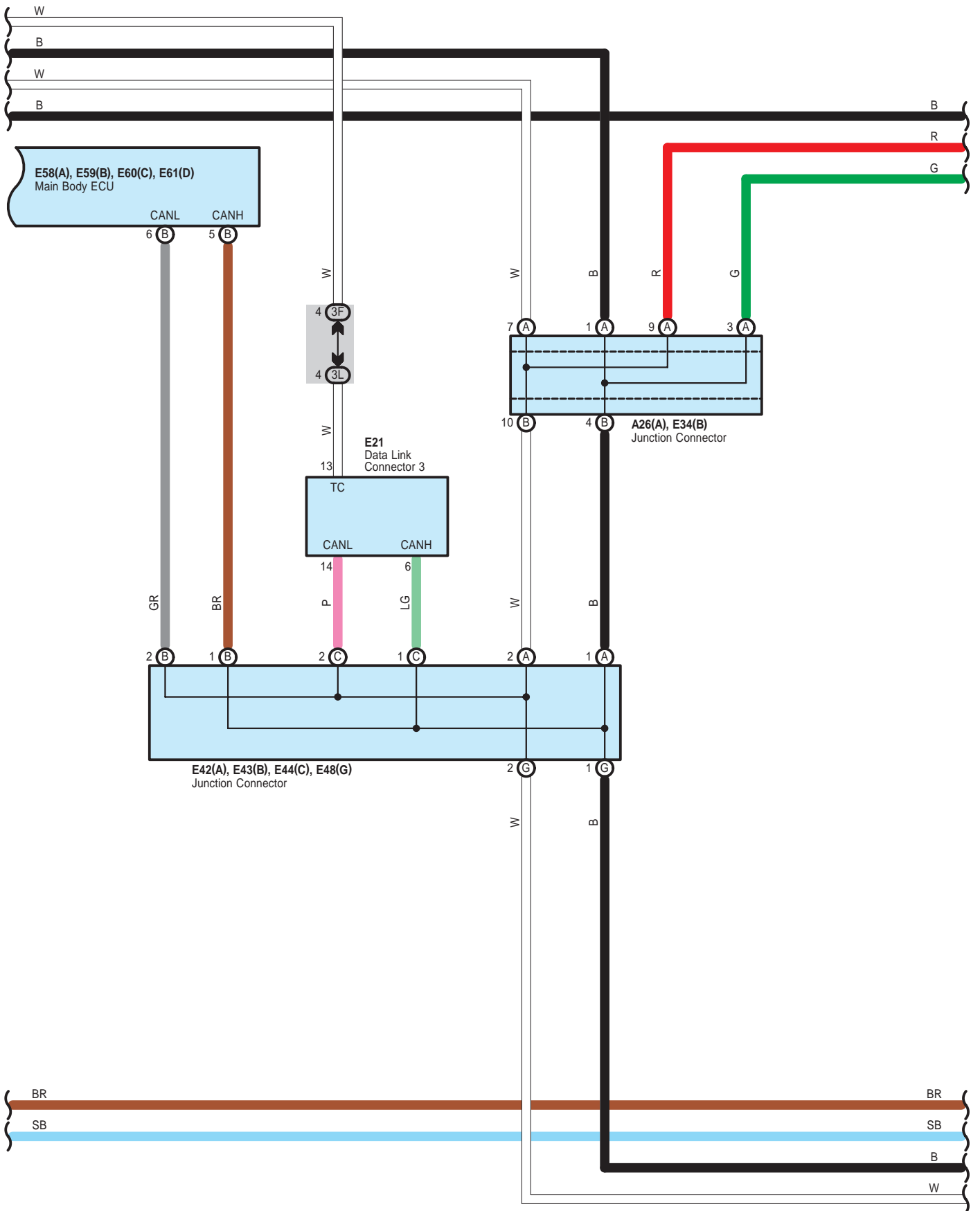

# Engine Control

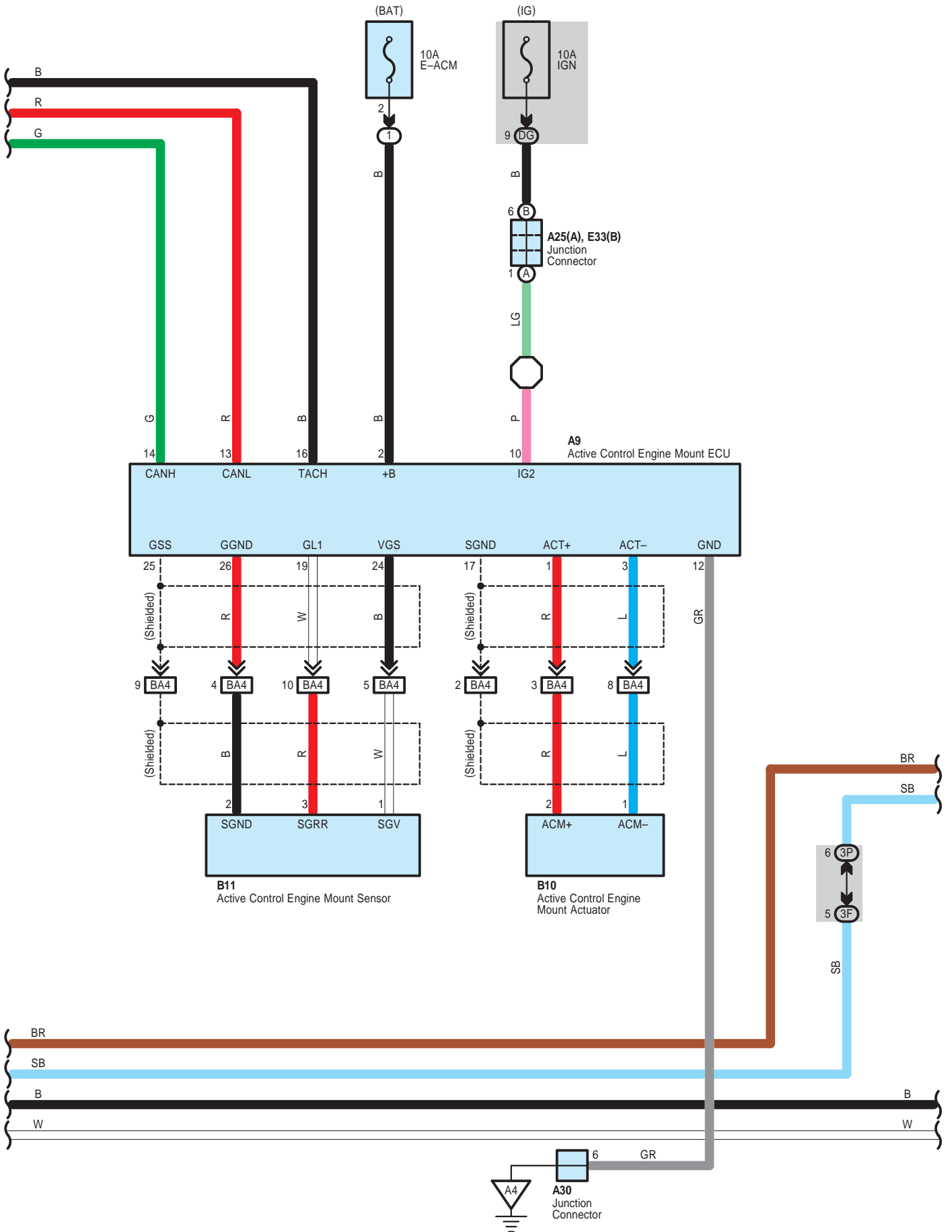

# Engine Control

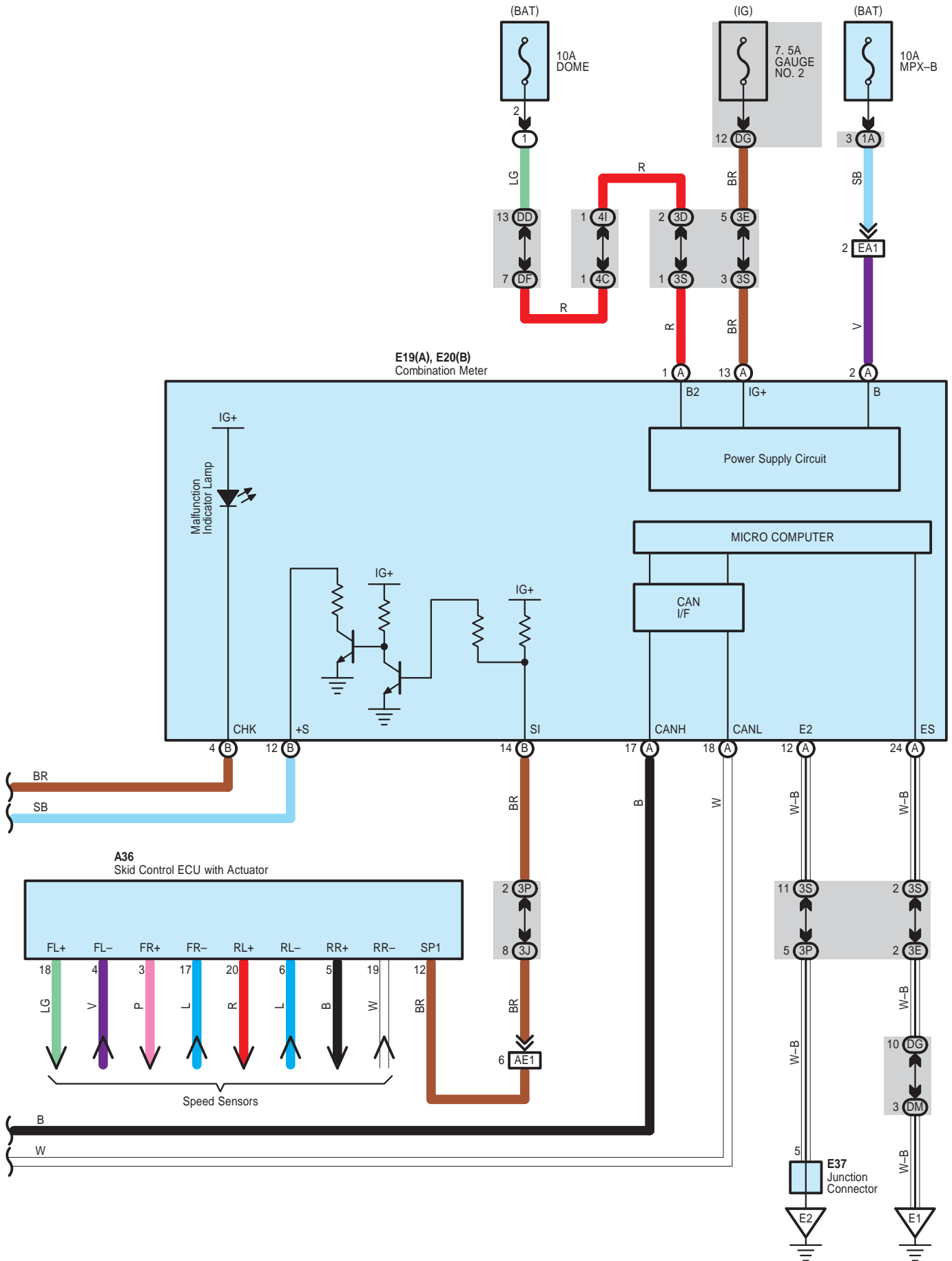

# Engine Control

A 2  
Black

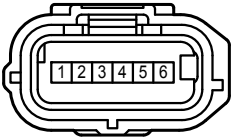

A 7  
Black

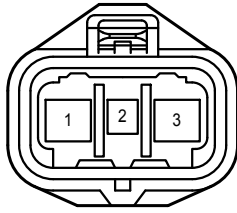

A 9  
Black

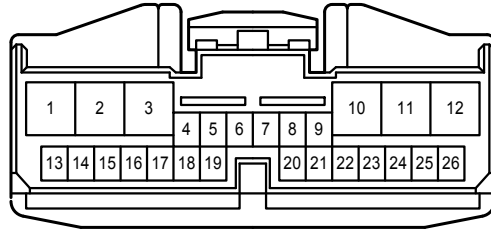

A 10  
Black

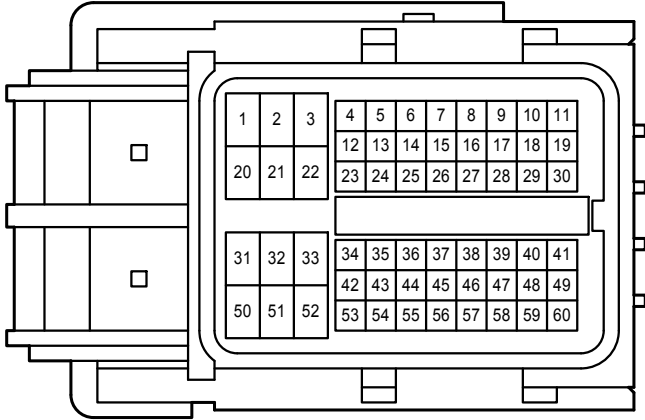

A 25  
Black

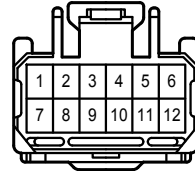

A 26  
Blue

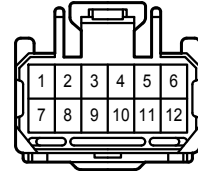

A 27  
White

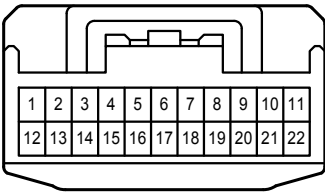

A 28  
White

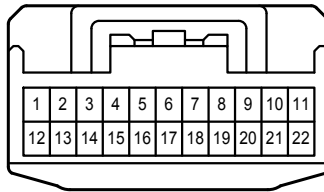

A 29  
Gray

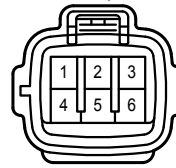

A 30  
Gray



A 36  
Black

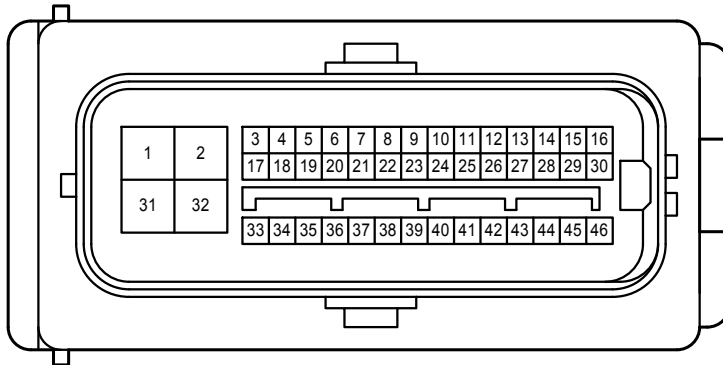

A 40  
Blue

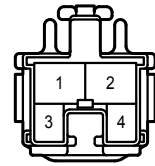

A 47  
Black

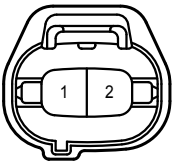

B 3  
Dark Gray



B 4  
Dark Gray



B 5  
Black



B 6  
Black



## Engine Control

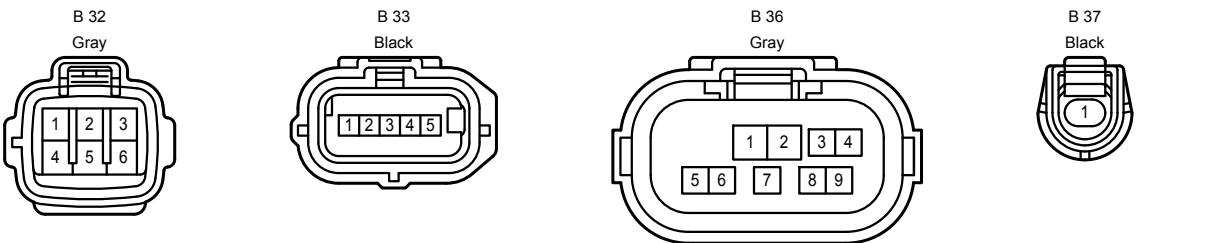
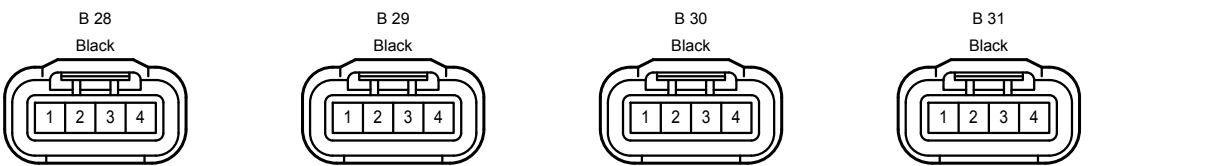
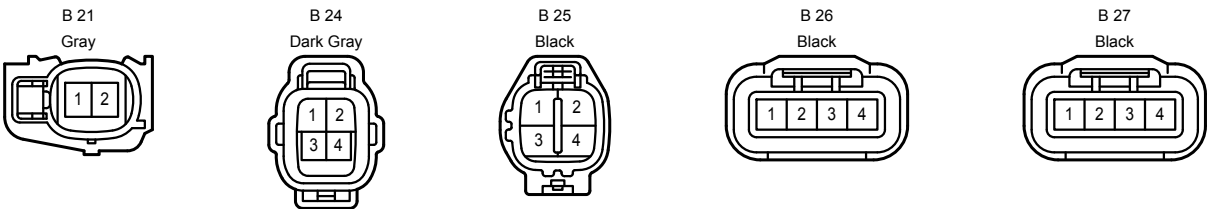
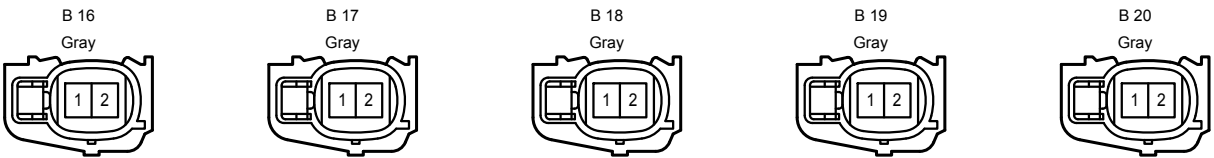
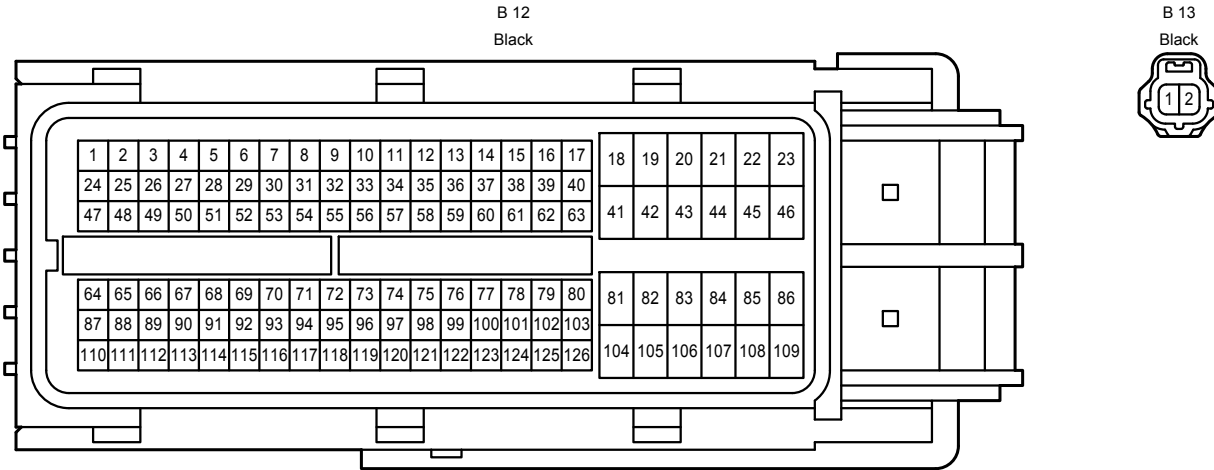
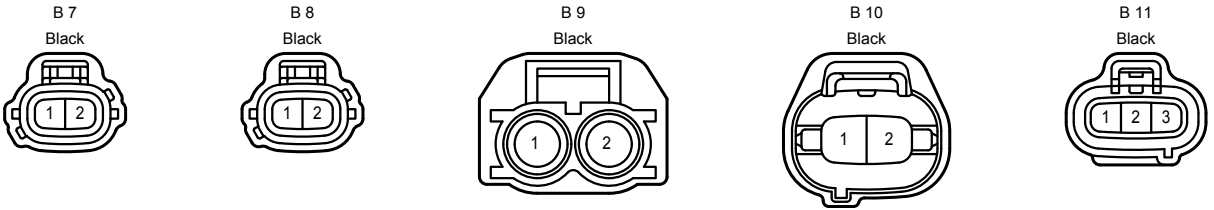

Engine Control

B 39  
Black

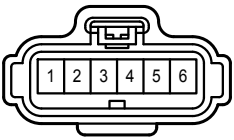

B 40  
Black

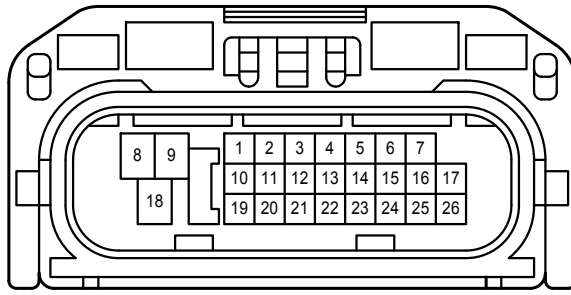

B 41  
Gray



B 42  
Black

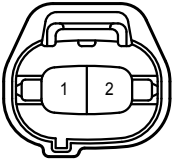

B 43  
Black

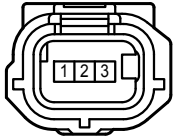

B 44  
Black

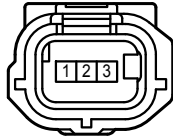

B 45  
Black

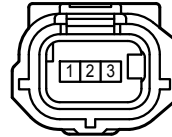

B 46  
Black

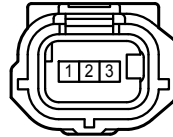

E 19  
White

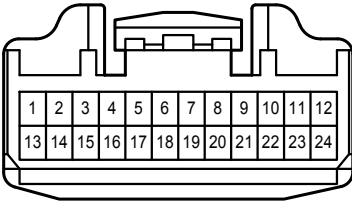

E 20  
White

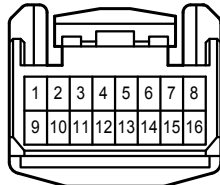

E 21  
Black

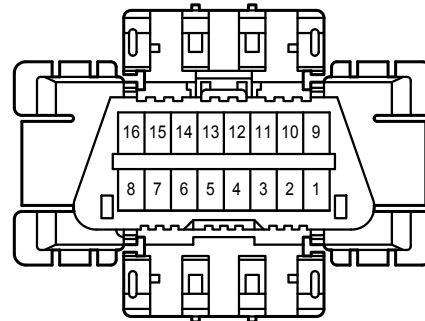

E 32  
White

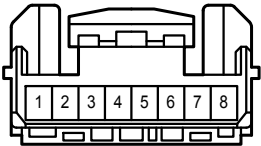

E 33  
Black

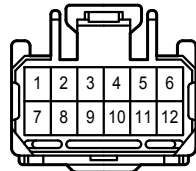

E 34  
Blue

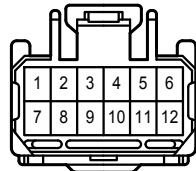

E 37  
White

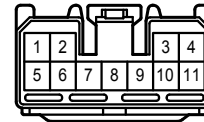

E 42  
White

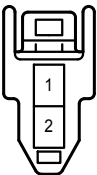

E 43  
White

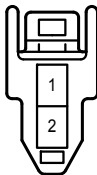

E 44  
White

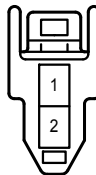

E 48  
White

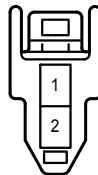

E 58  
White

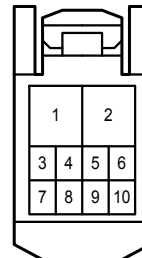

E 59  
White

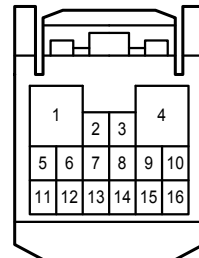



Engine Control

E 60  
White

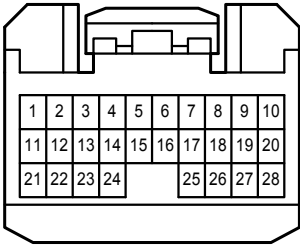

E 61  
White

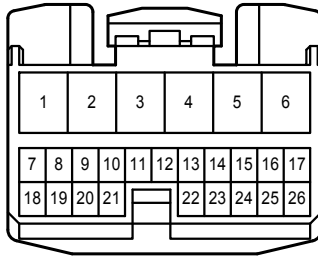

L 2  
Black

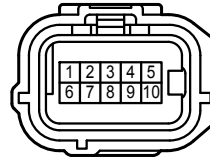

L 13  
White



V 1  
Black

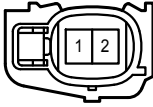

V 2  
Gray

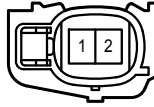

1A  
White

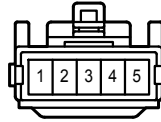

1D  
White

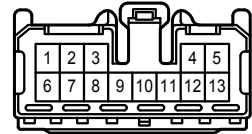

1E  
Black

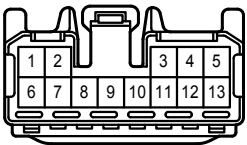

1G

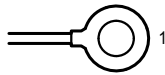

3A  
White

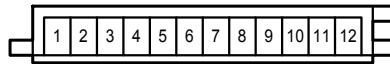

3D  
White

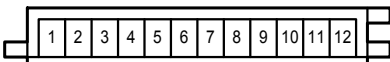

3E  
Gray

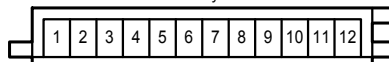

3F  
White

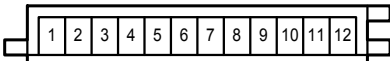

3I  
White

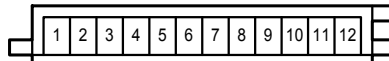

3J  
Gray

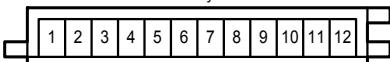

3L  
Gray

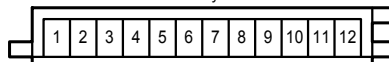

3P  
White



3Q  
Gray

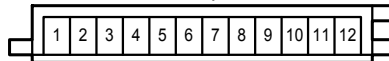

3S  
Gray

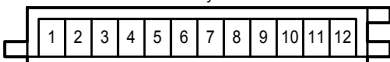

3U  
Gray

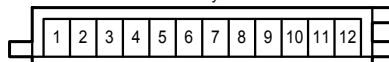

4C  
White

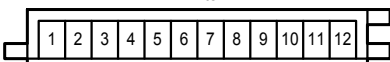

4E  
White

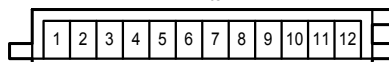

4H  
Gray

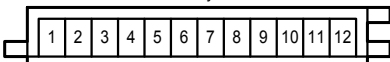

4I  
White

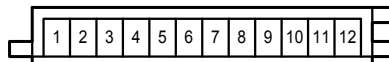

Engine Control

4M  
White

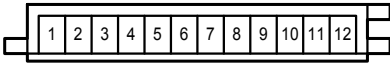

DC  
White

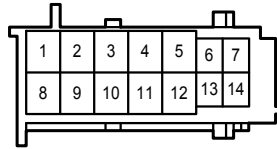

DD  
White

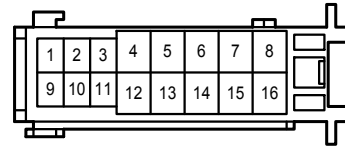

DF  
White

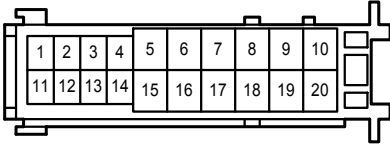

DG  
White

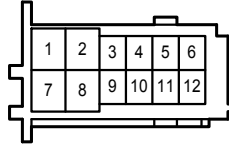

DI  
White

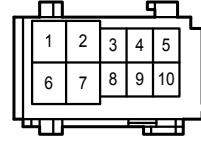

DM  
White

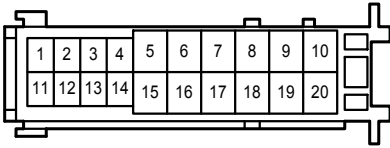

AA1  
White

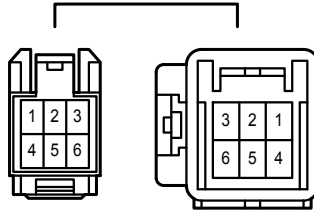

AE1  
Gray

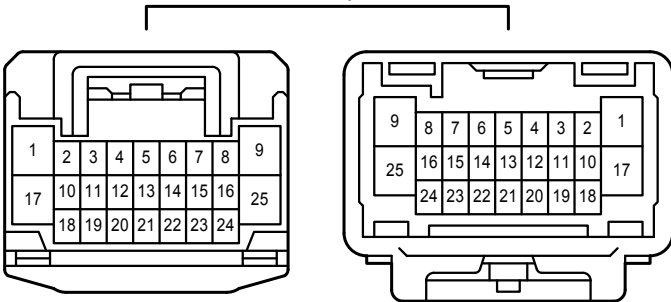

AE5  
White

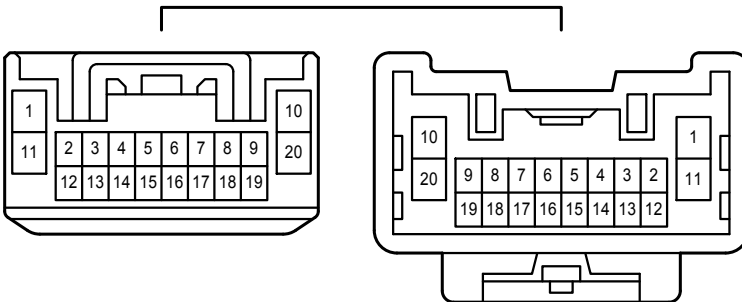

BA1  
White

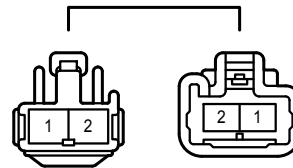

Engine Control

BA2

Black White

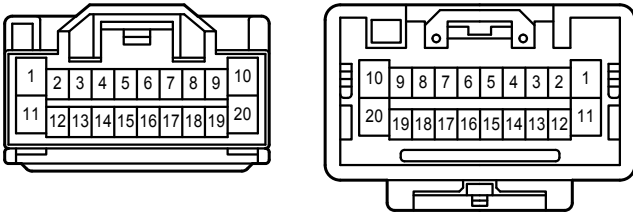

BA3

White

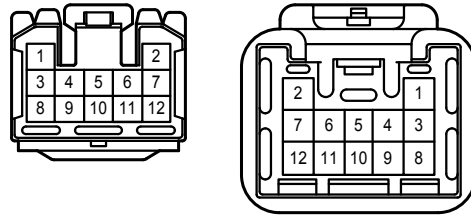

BA4

Gray White

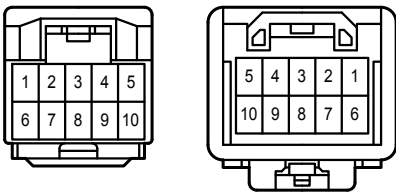

BV1

Gray

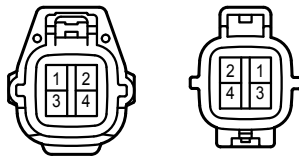

EA1

White

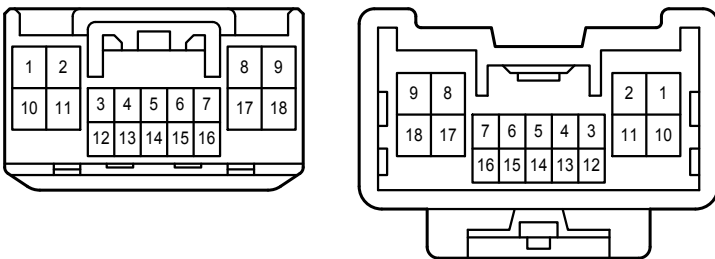

LA1

Black

