

Engine Control

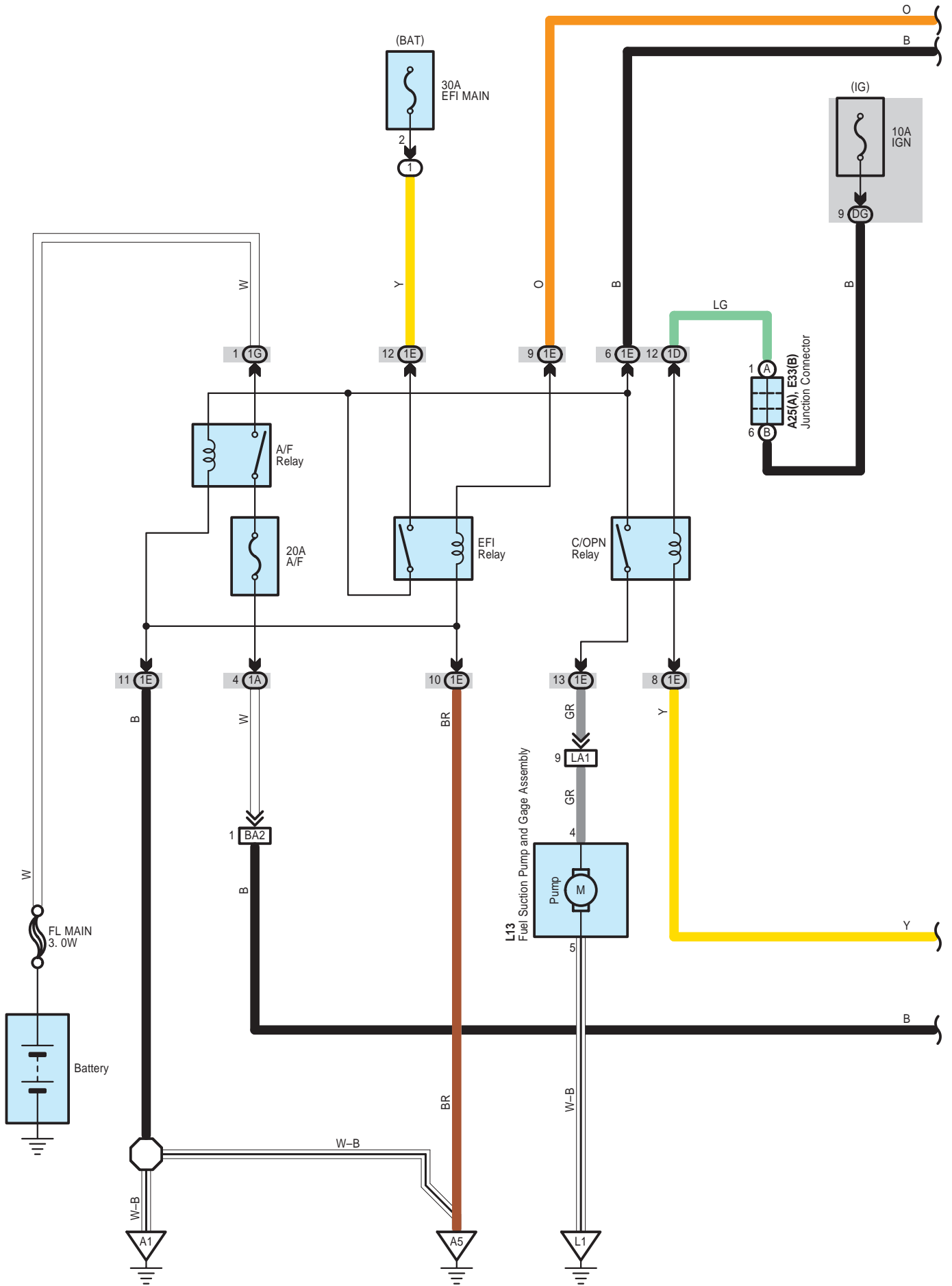

Engine Control

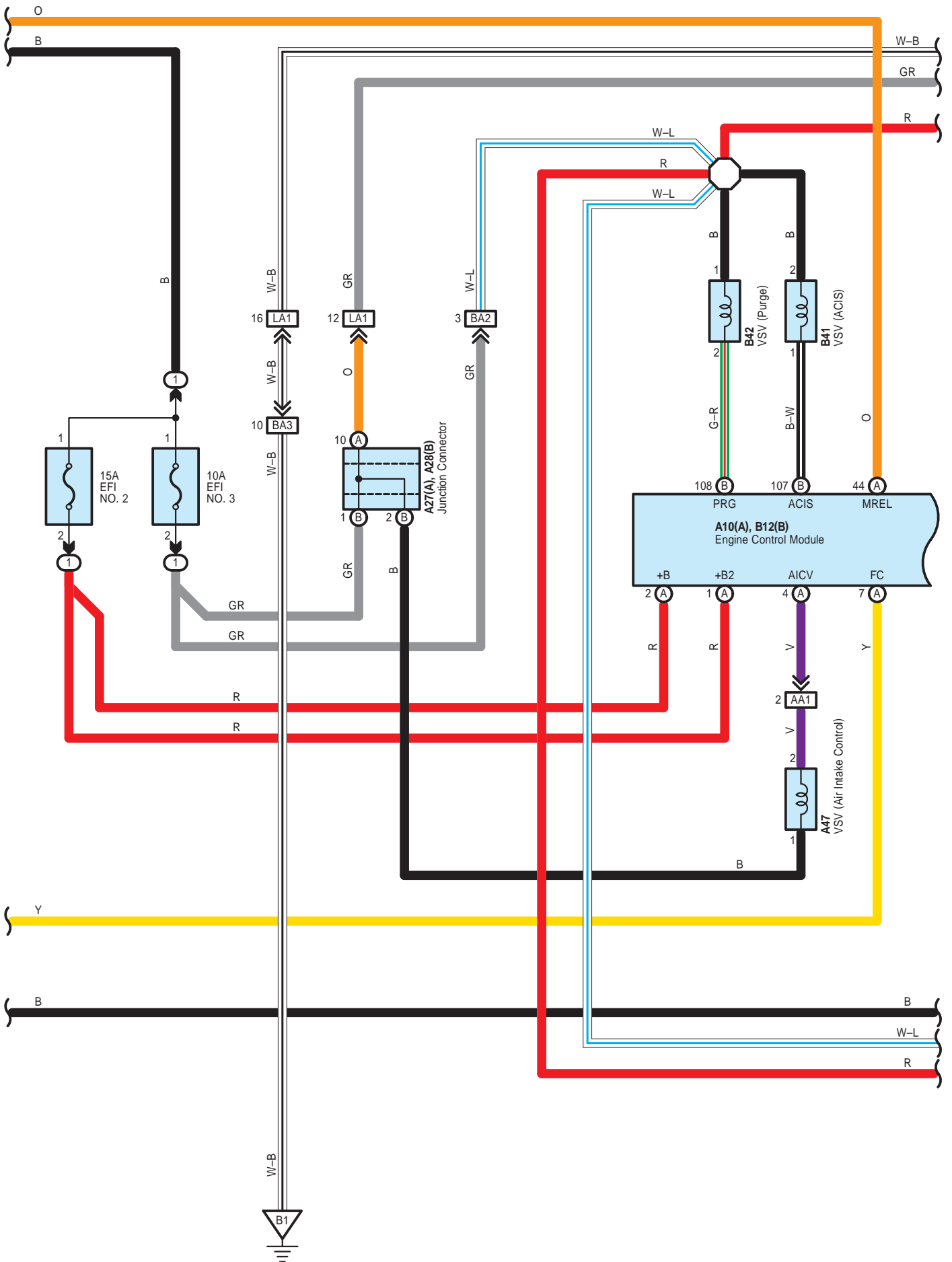

Engine Control

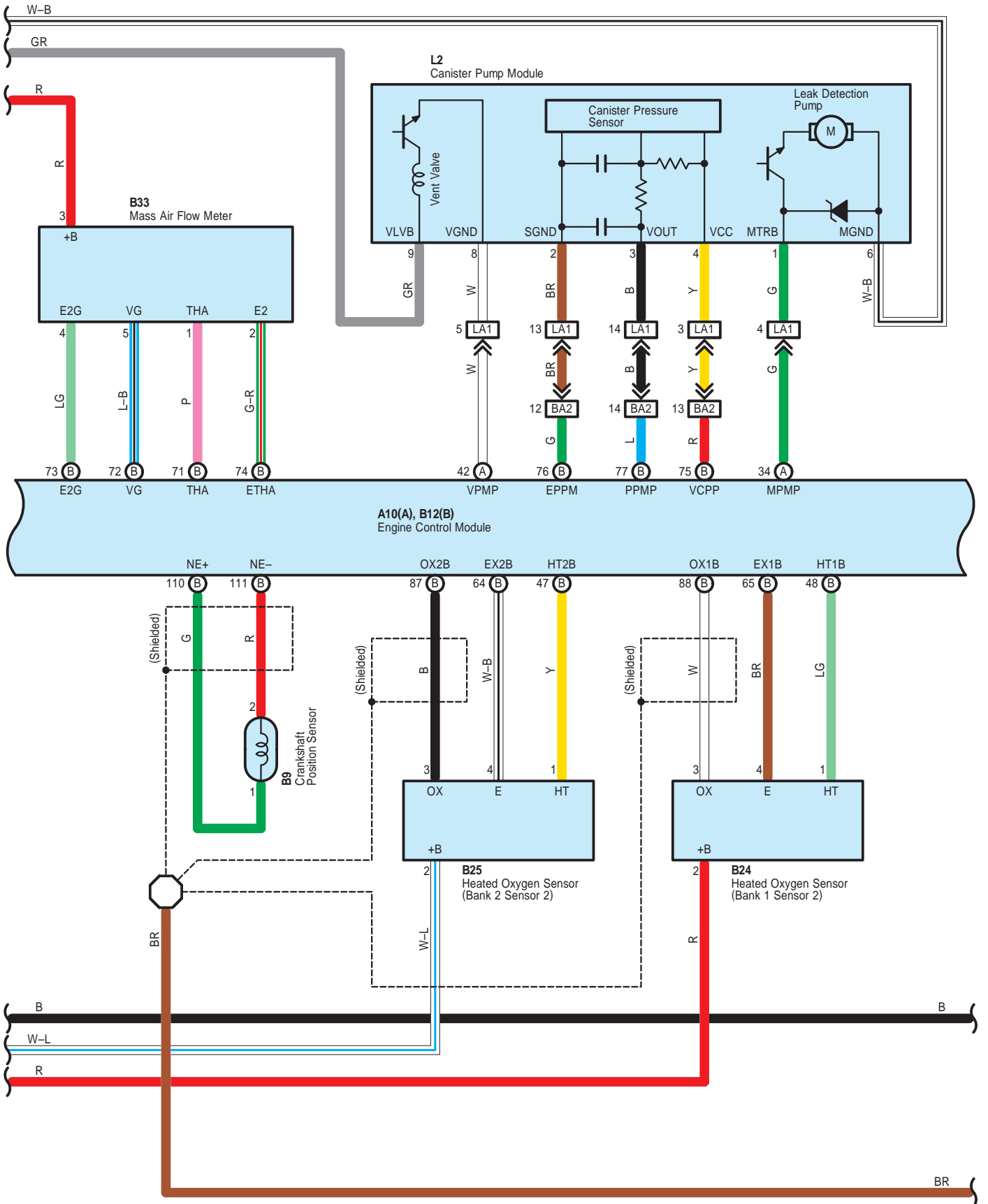

Engine Control

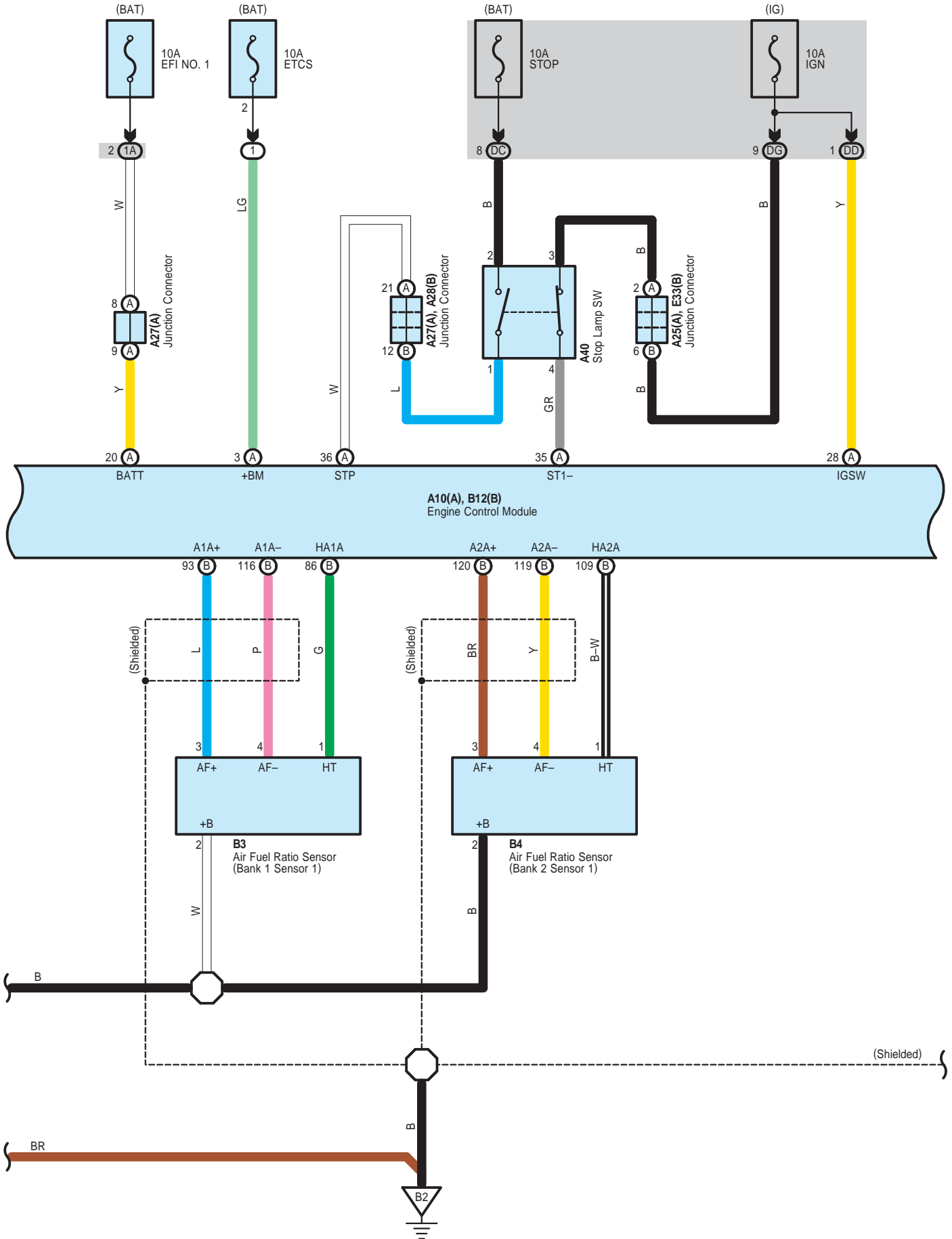

Engine Control

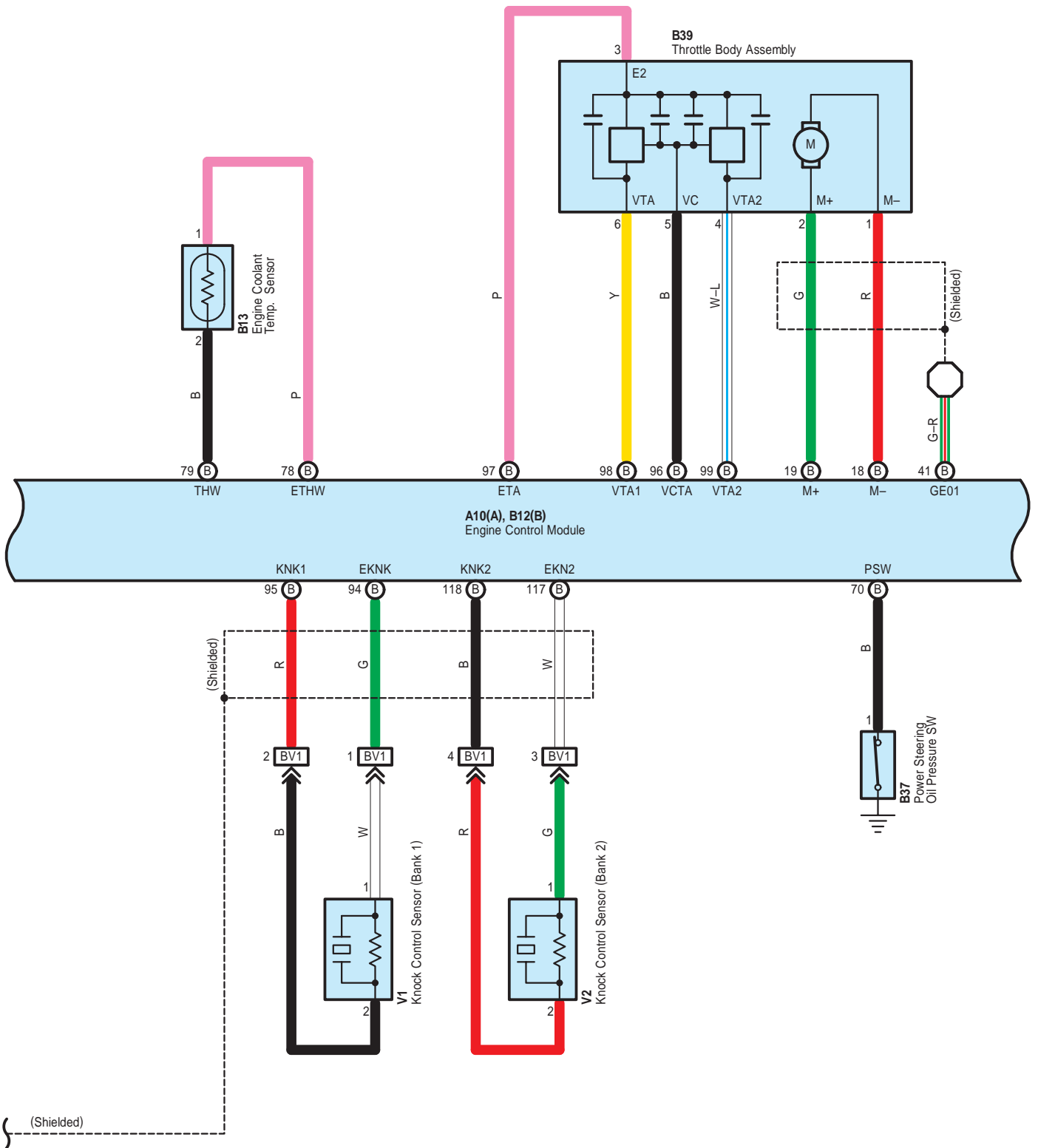

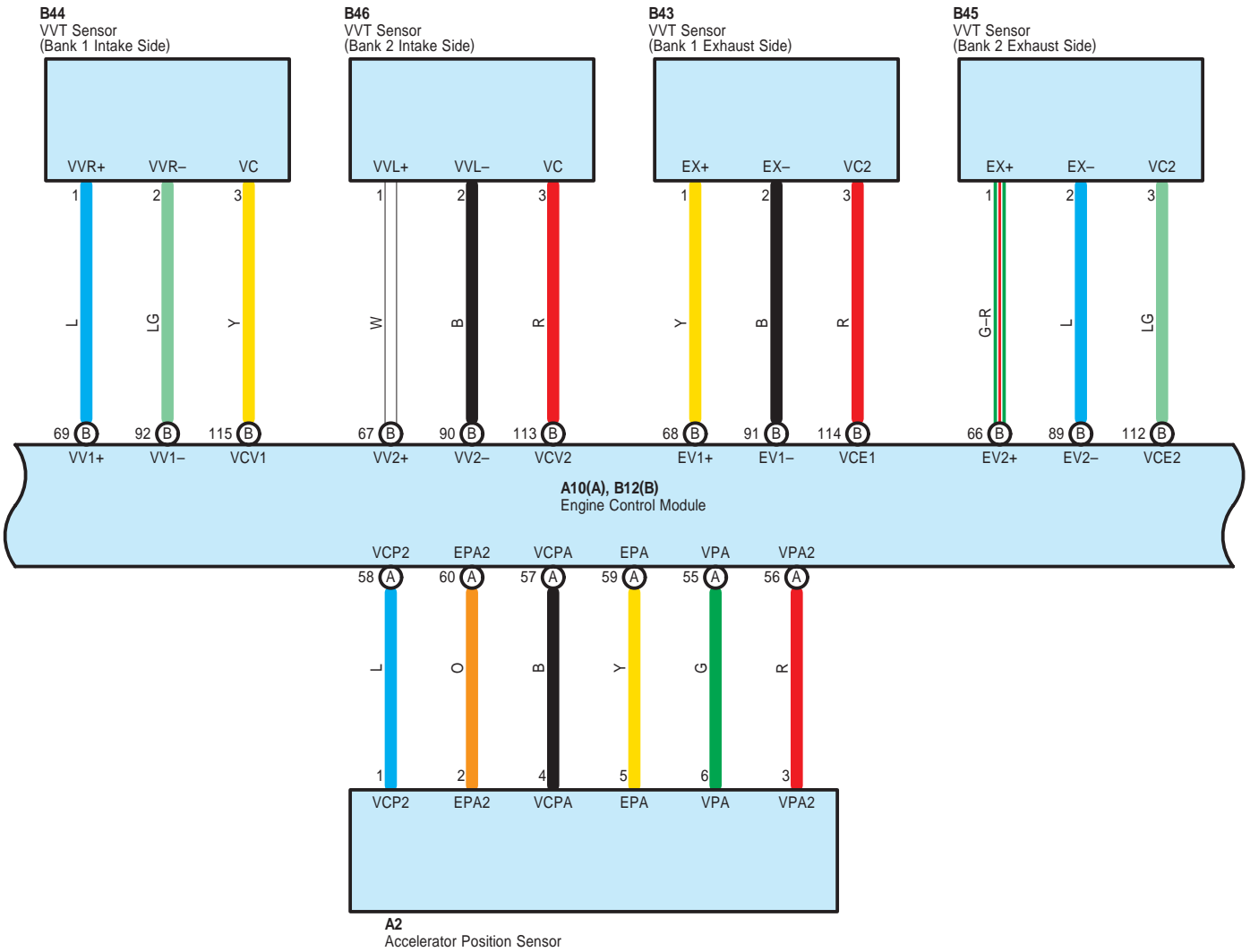

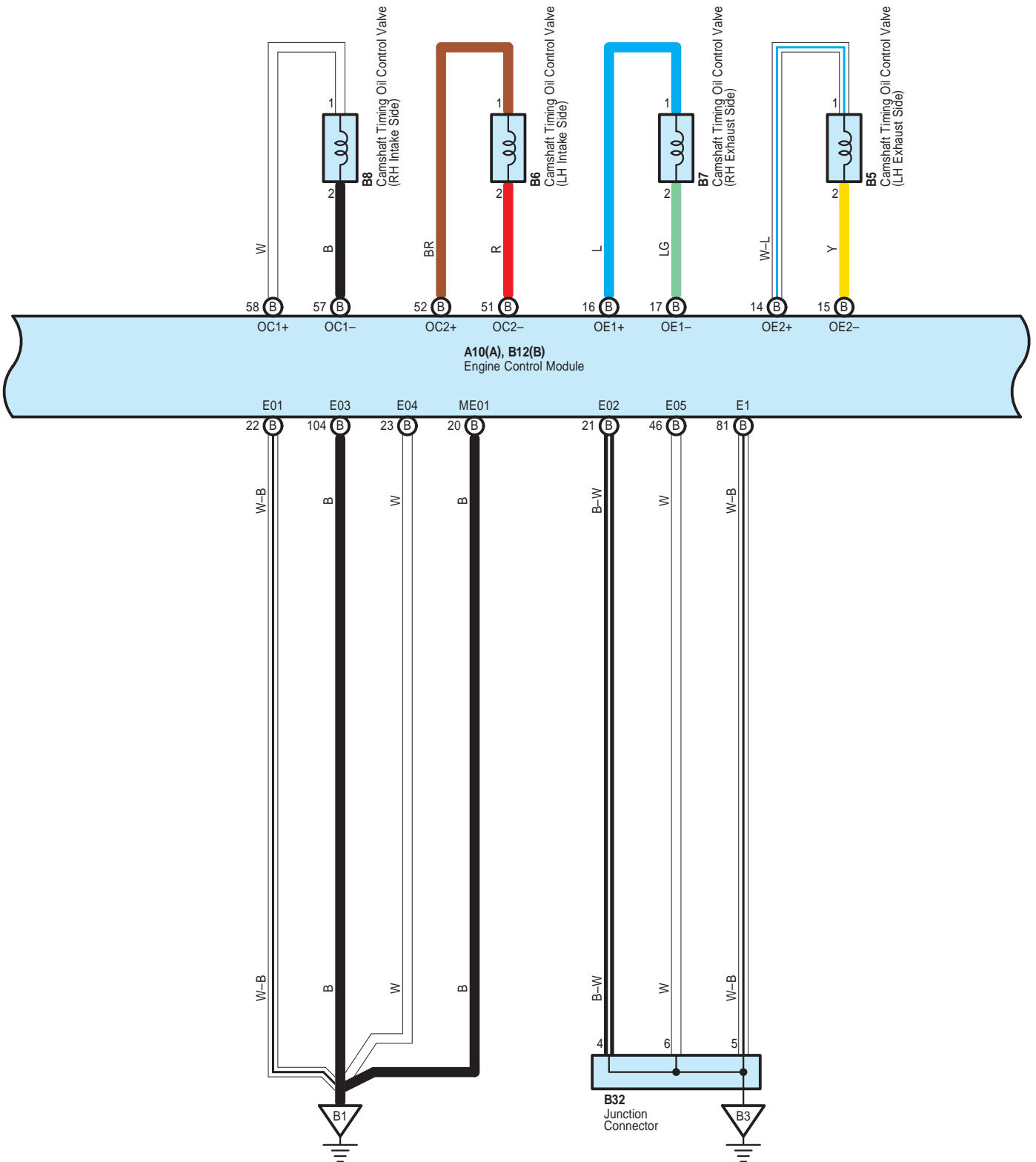

Engine Control

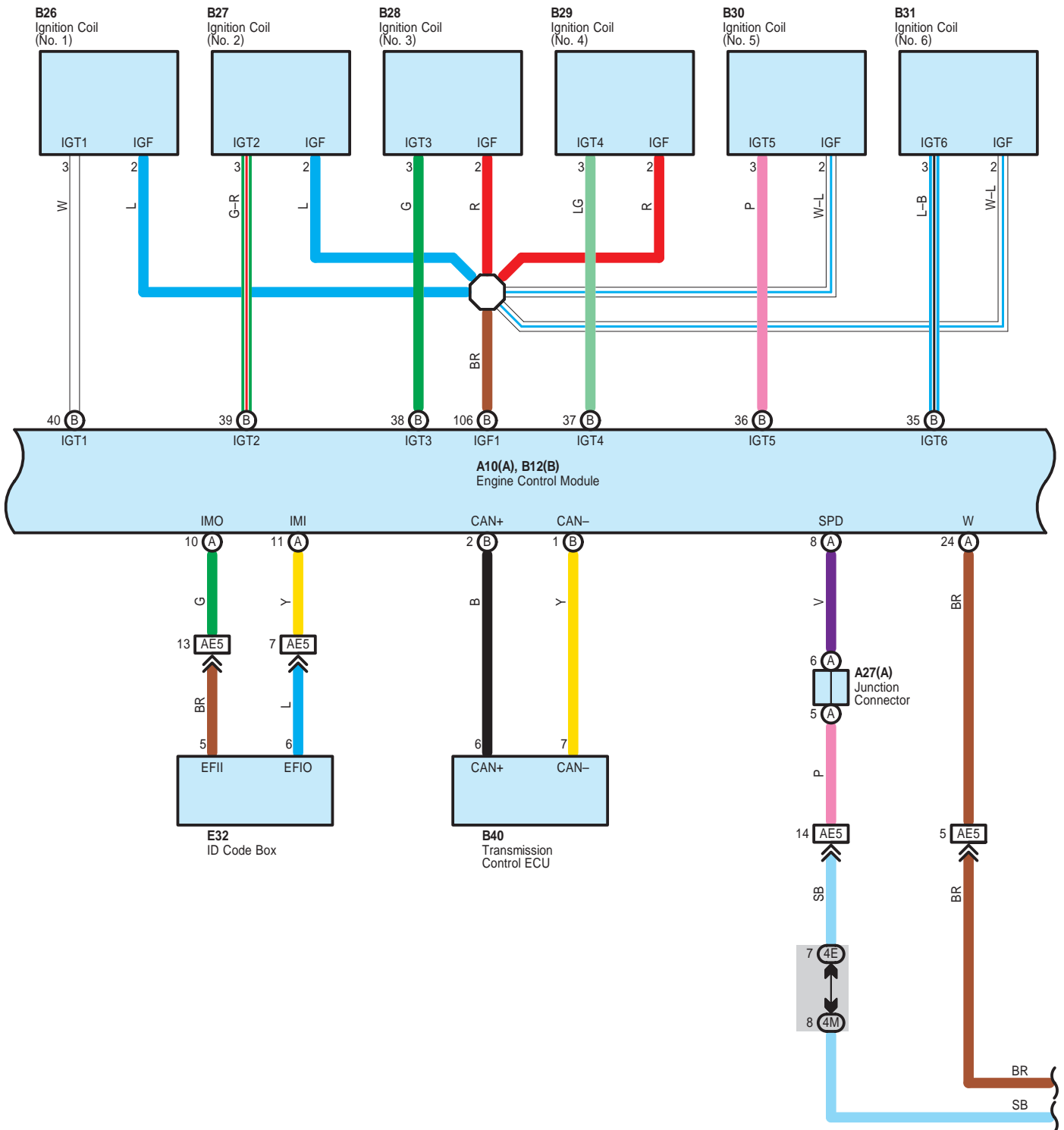

Engine Control

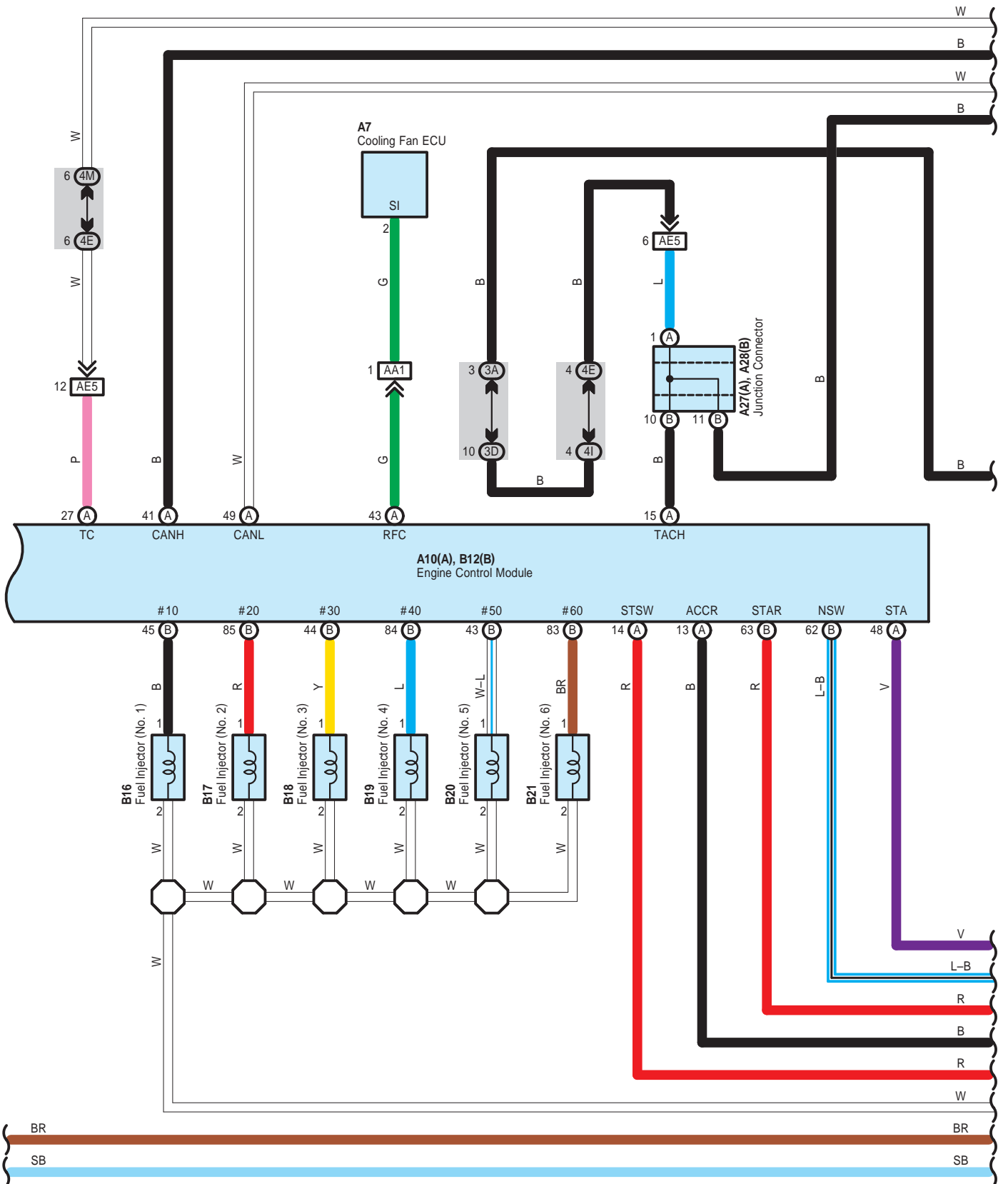

Engine Control

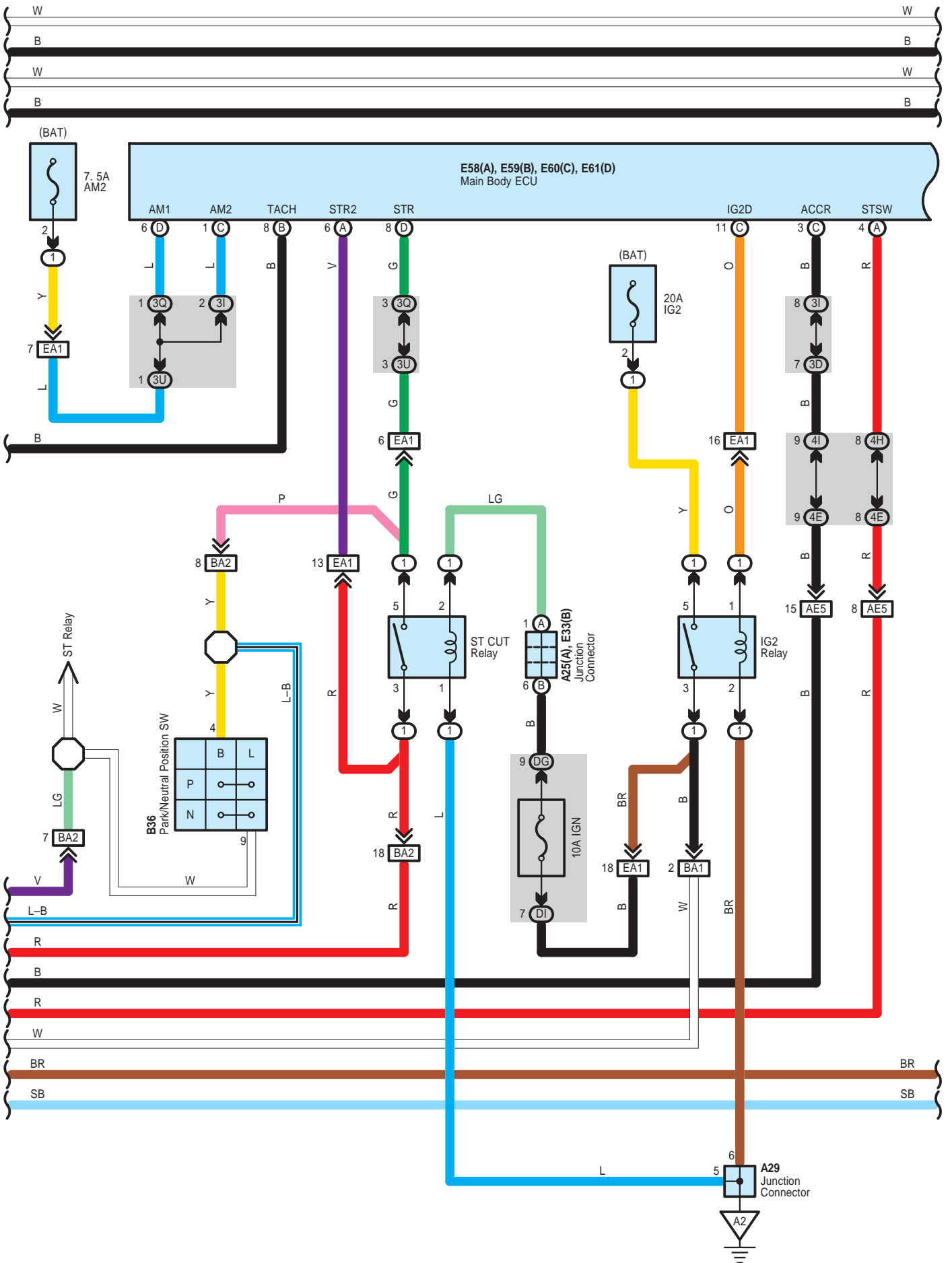

Engine Control

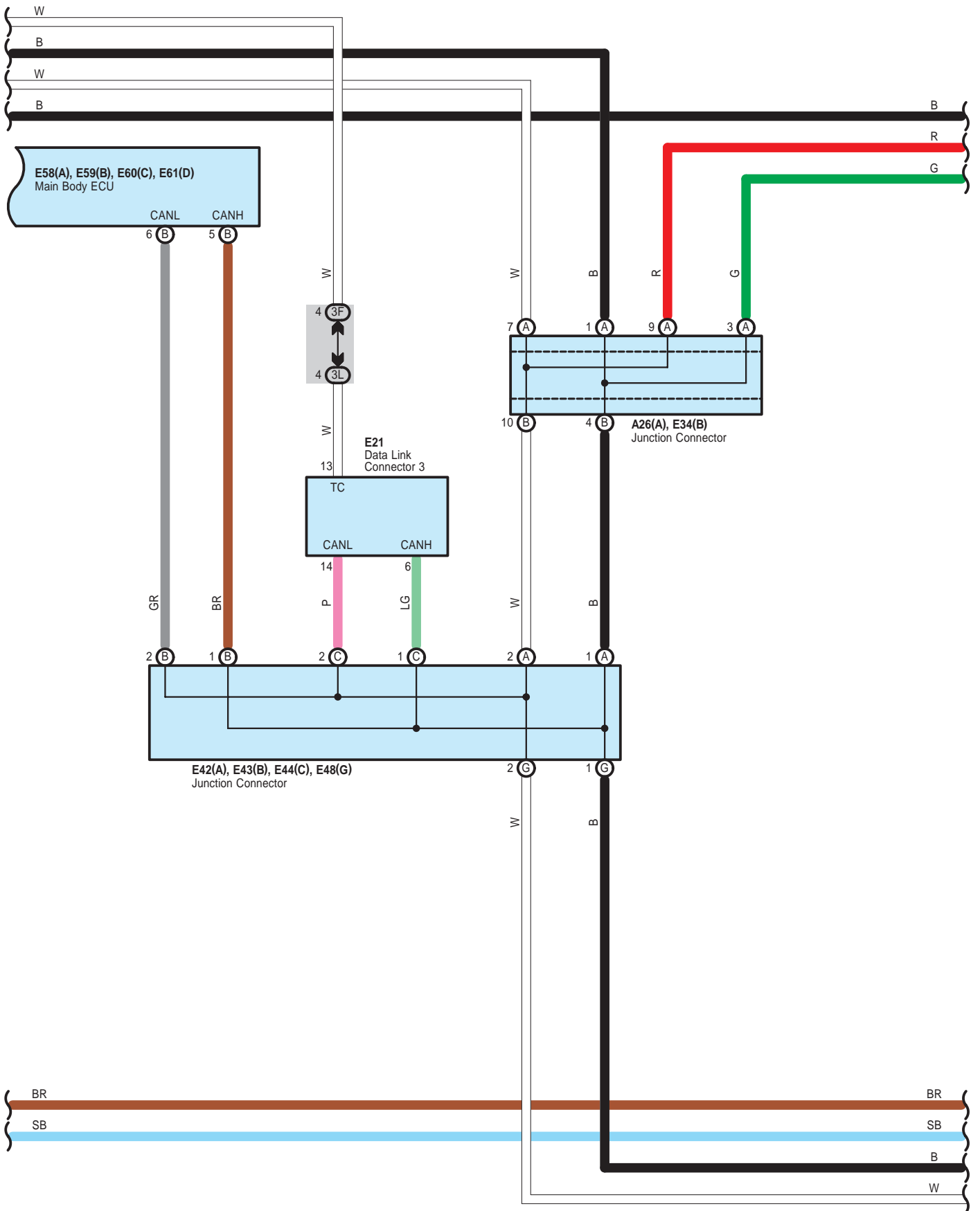

Engine Control

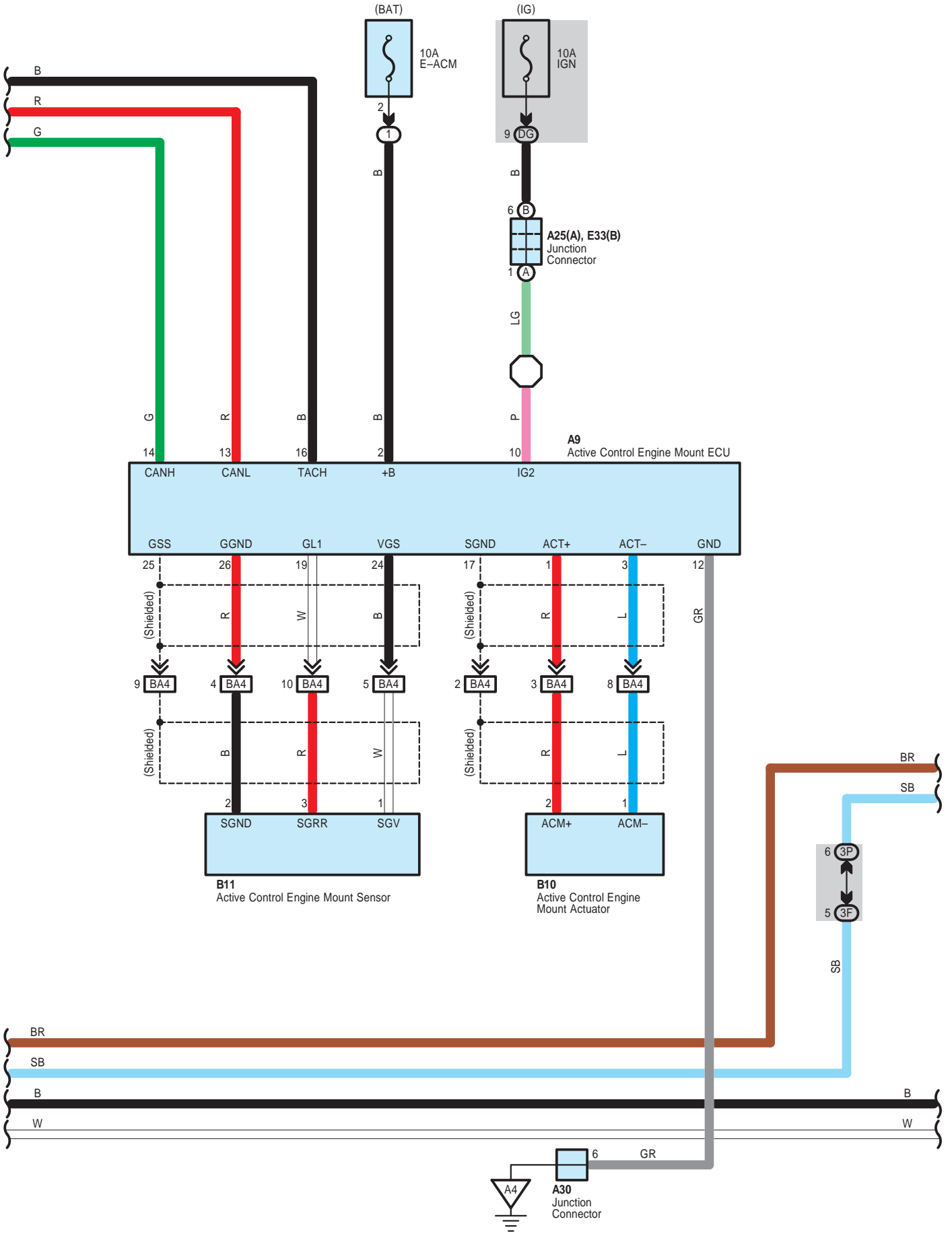

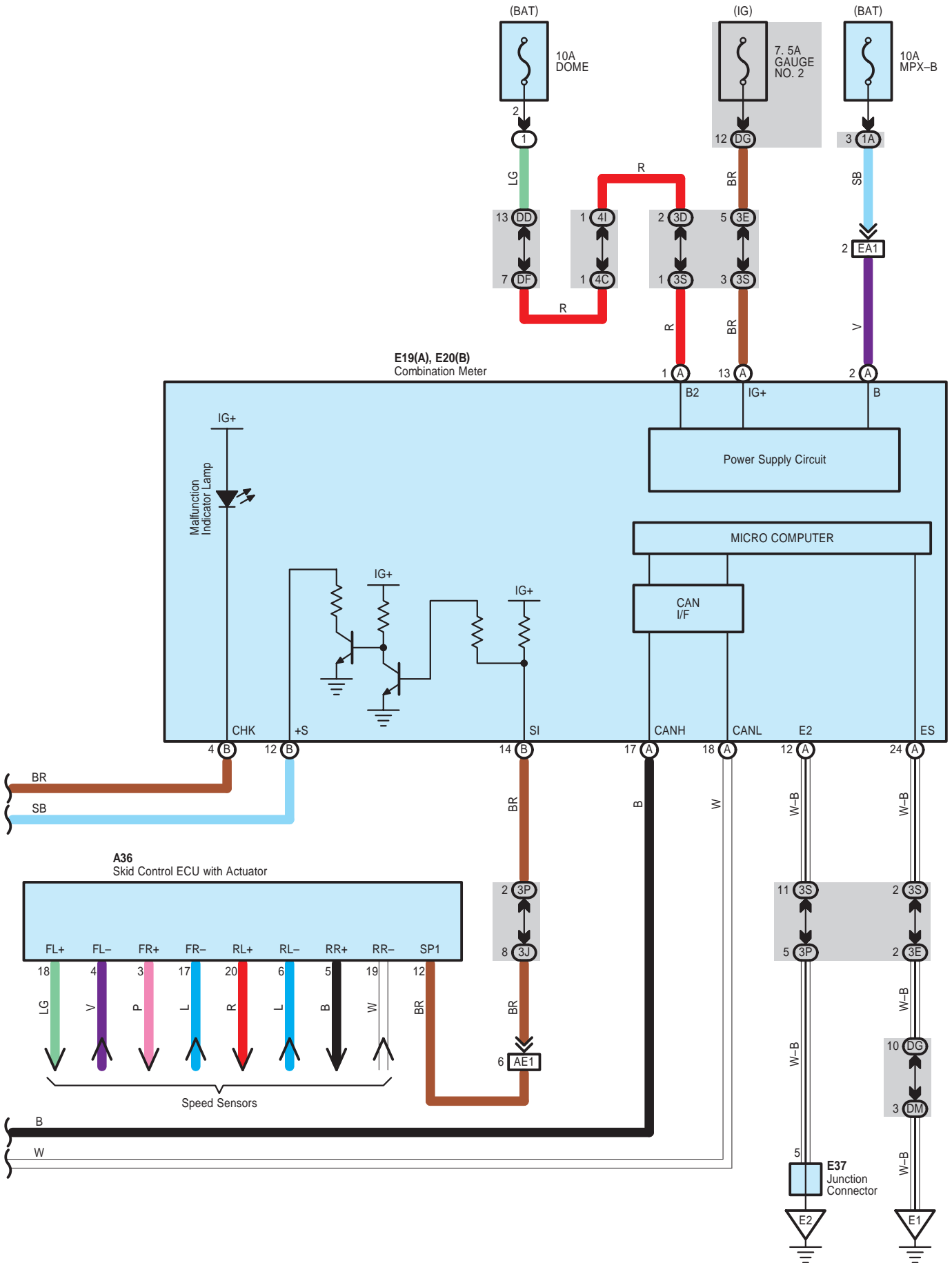

Engine Control

A 2
Black

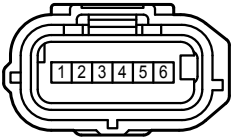

A 7
Black

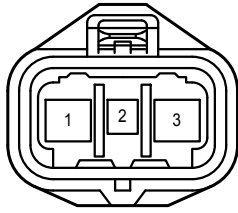

A 9
Black

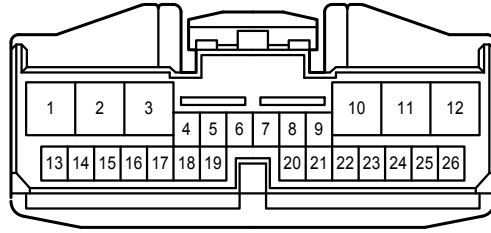

A 10
Black

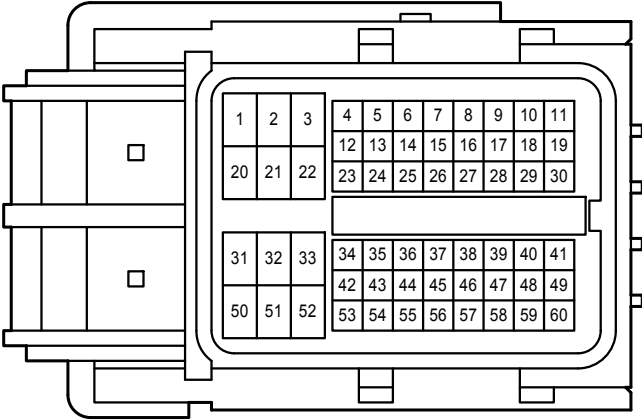

A 25
Black

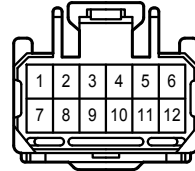

A 26
Blue

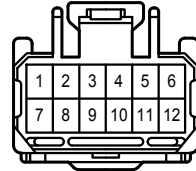

A 27
White

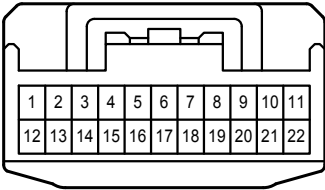

A 28
White

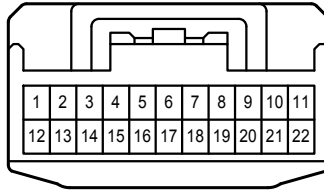

A 29
Gray



A 30
Gray



A 36
Black

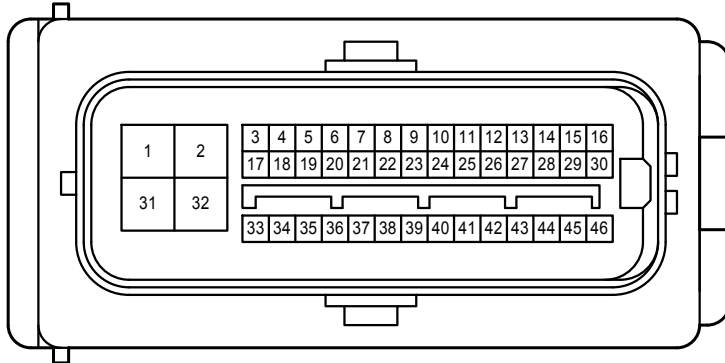

A 40
Blue

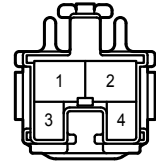

A 47
Black

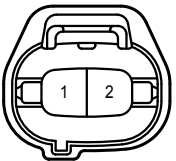

B 3
Dark Gray



B 4
Dark Gray



B 5
Black



B 6
Black



Engine Control

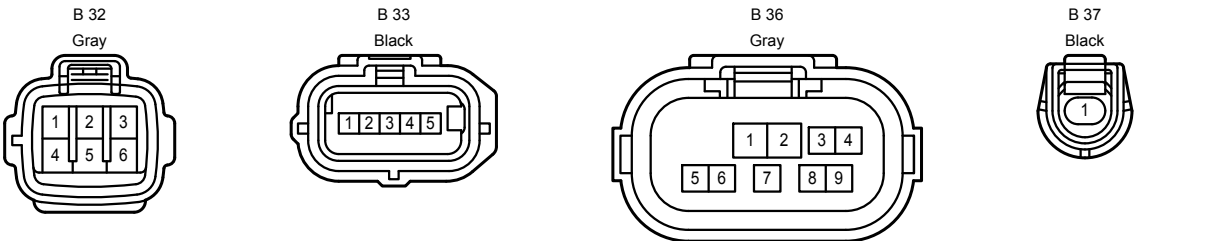
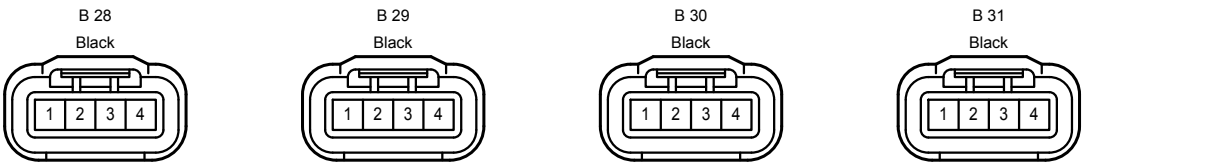
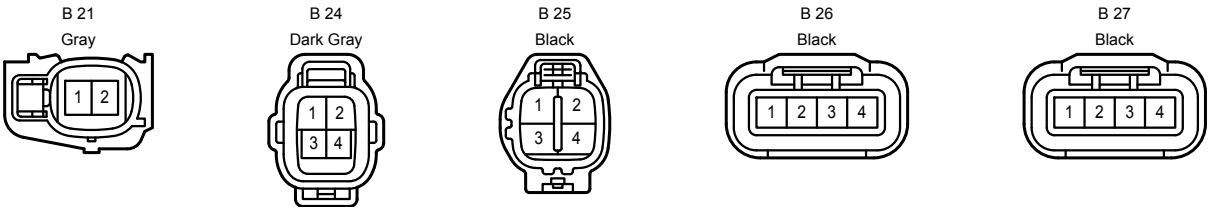
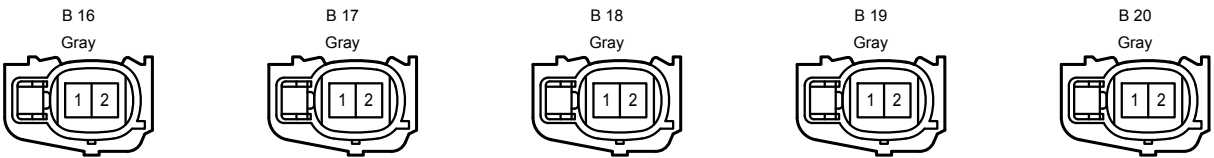
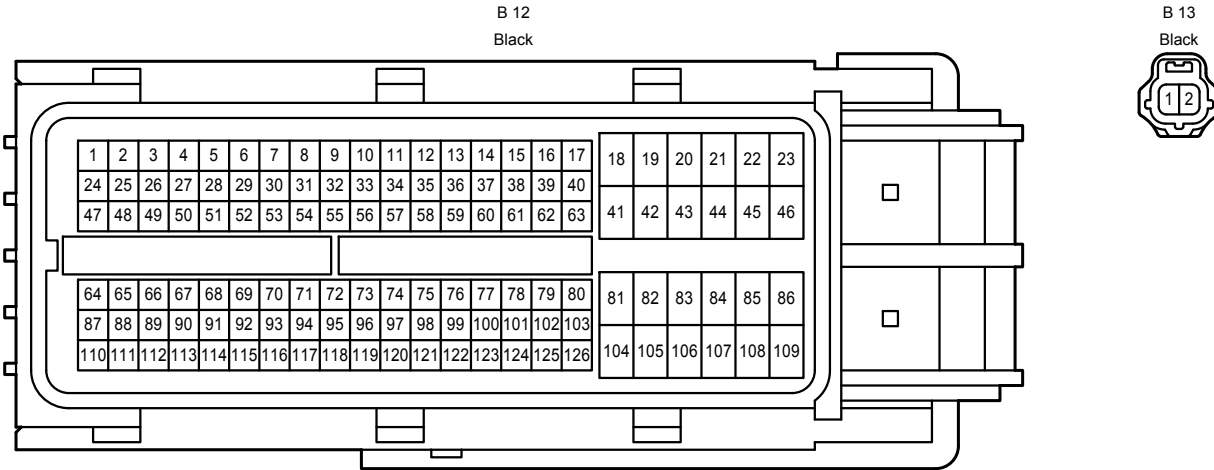
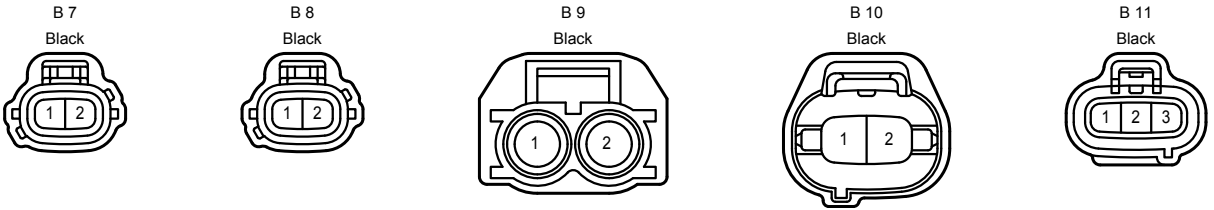

Engine Control

B 39
Black

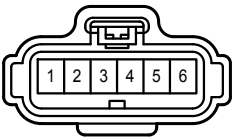

B 40
Black

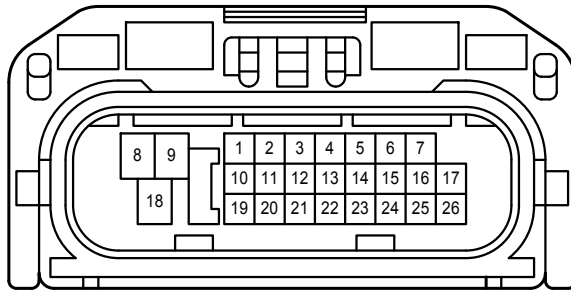

B 41
Gray



B 42
Black

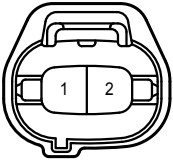

B 43
Black

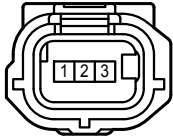

B 44
Black

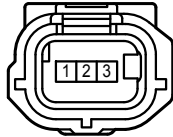

B 45
Black

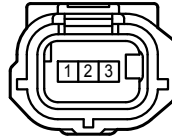

B 46
Black

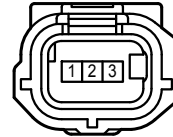

E 19
White

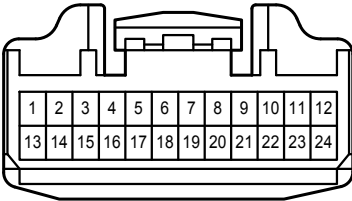

E 20
White

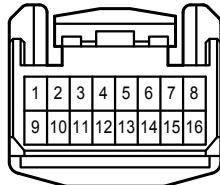

E 21
Black

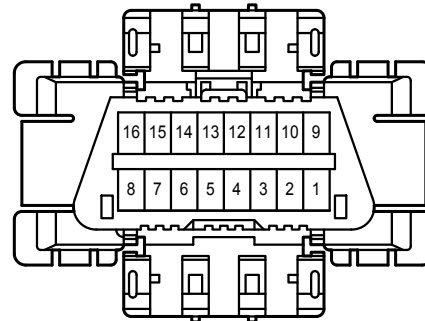

E 32
White

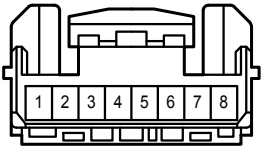

E 33
Black

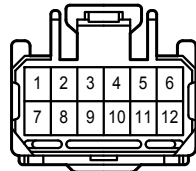

E 34
Blue

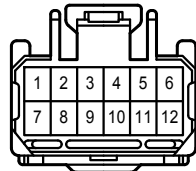

E 37
White

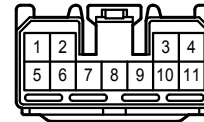

E 42
White

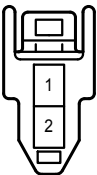

E 43
White

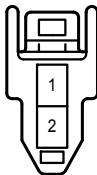

E 44
White

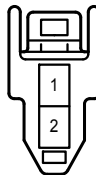

E 48
White

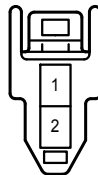

E 58
White

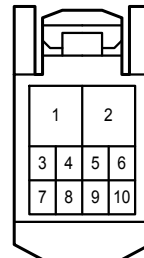

E 59
White

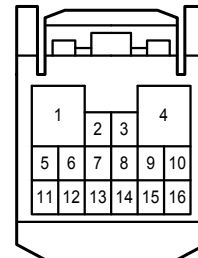

Engine Control

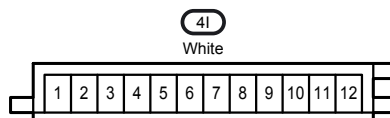
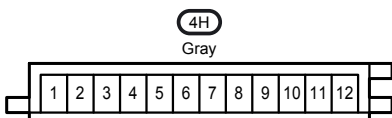
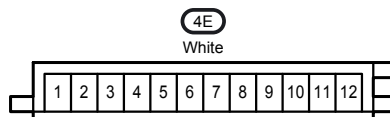
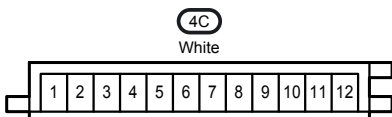
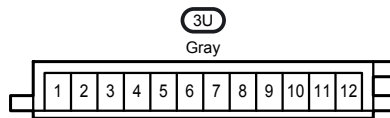
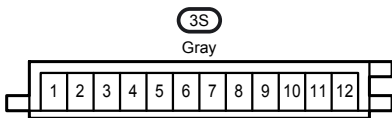
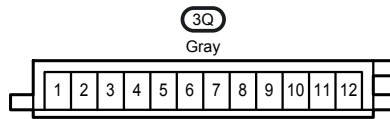
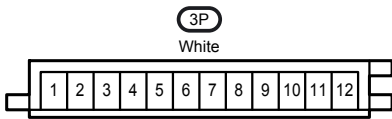
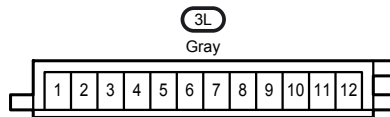
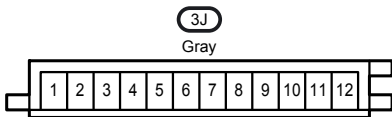
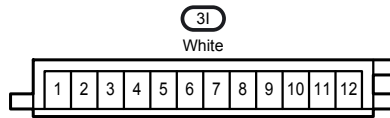
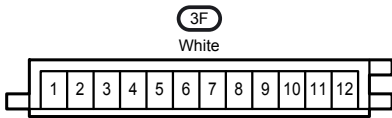
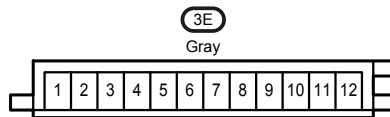
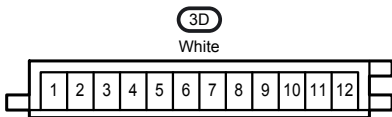
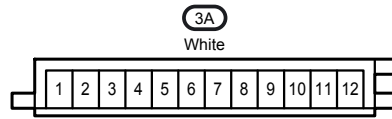
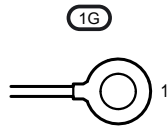
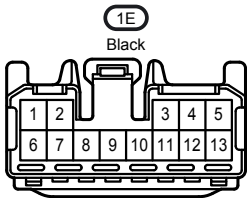
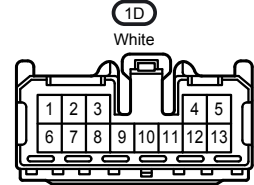
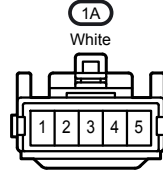
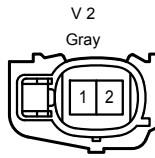
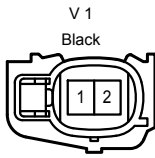
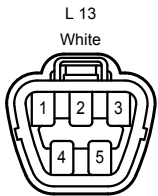
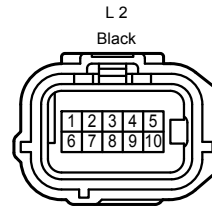
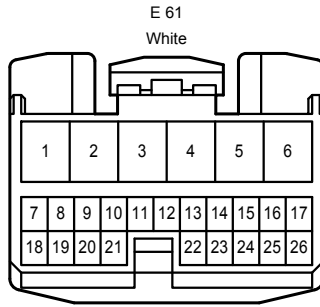
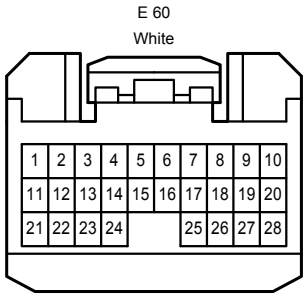

Engine Control

4M

White

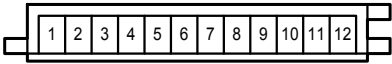

DC

White

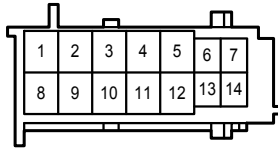

DD

White

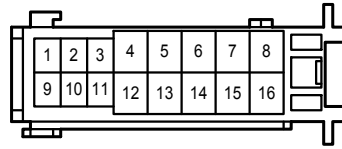

DF

White

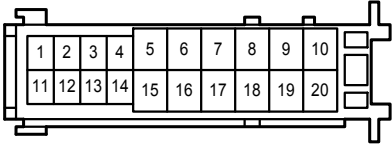

DG

White

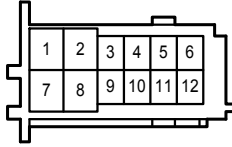

DI

White

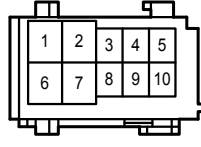

DM

White

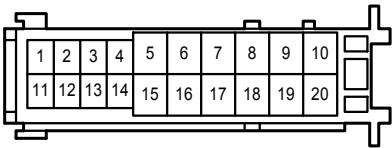

AA1

White

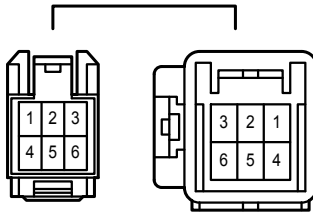

AE1

Gray

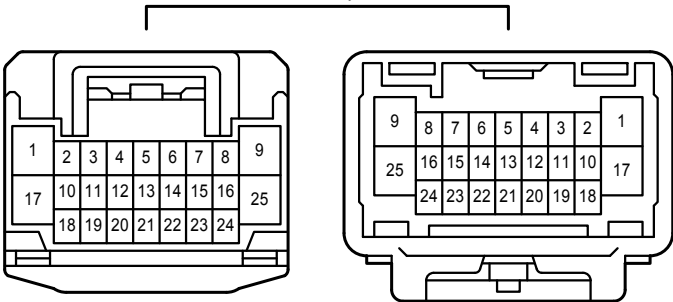

AE5

White

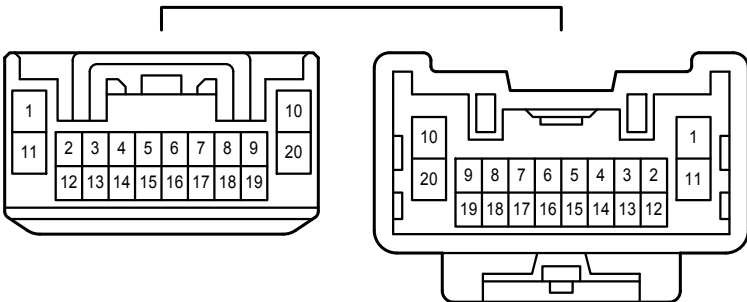

BA1

White

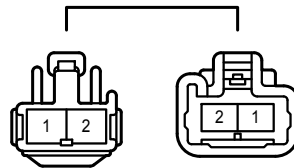

Engine Control

BA2

Black White

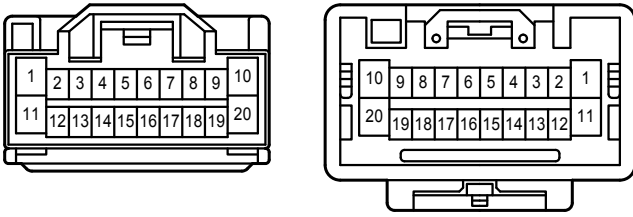

BA3

White

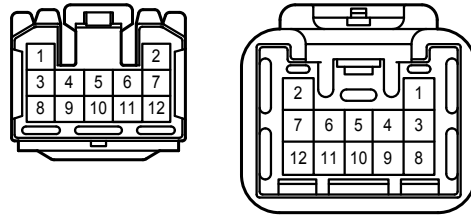

BA4

Gray White

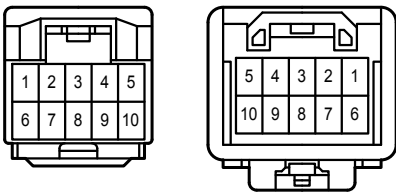

BV1

Gray

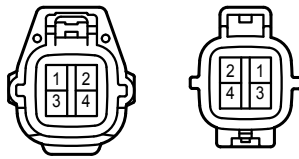

EA1

White

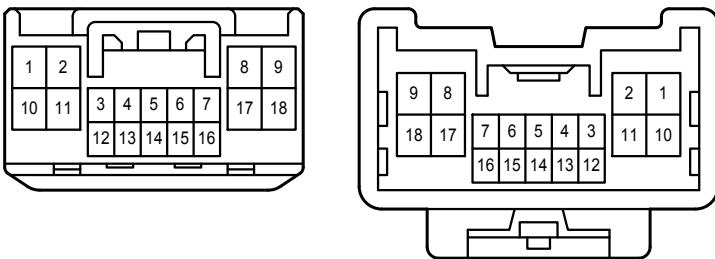

LA1

Black

