

Power Window

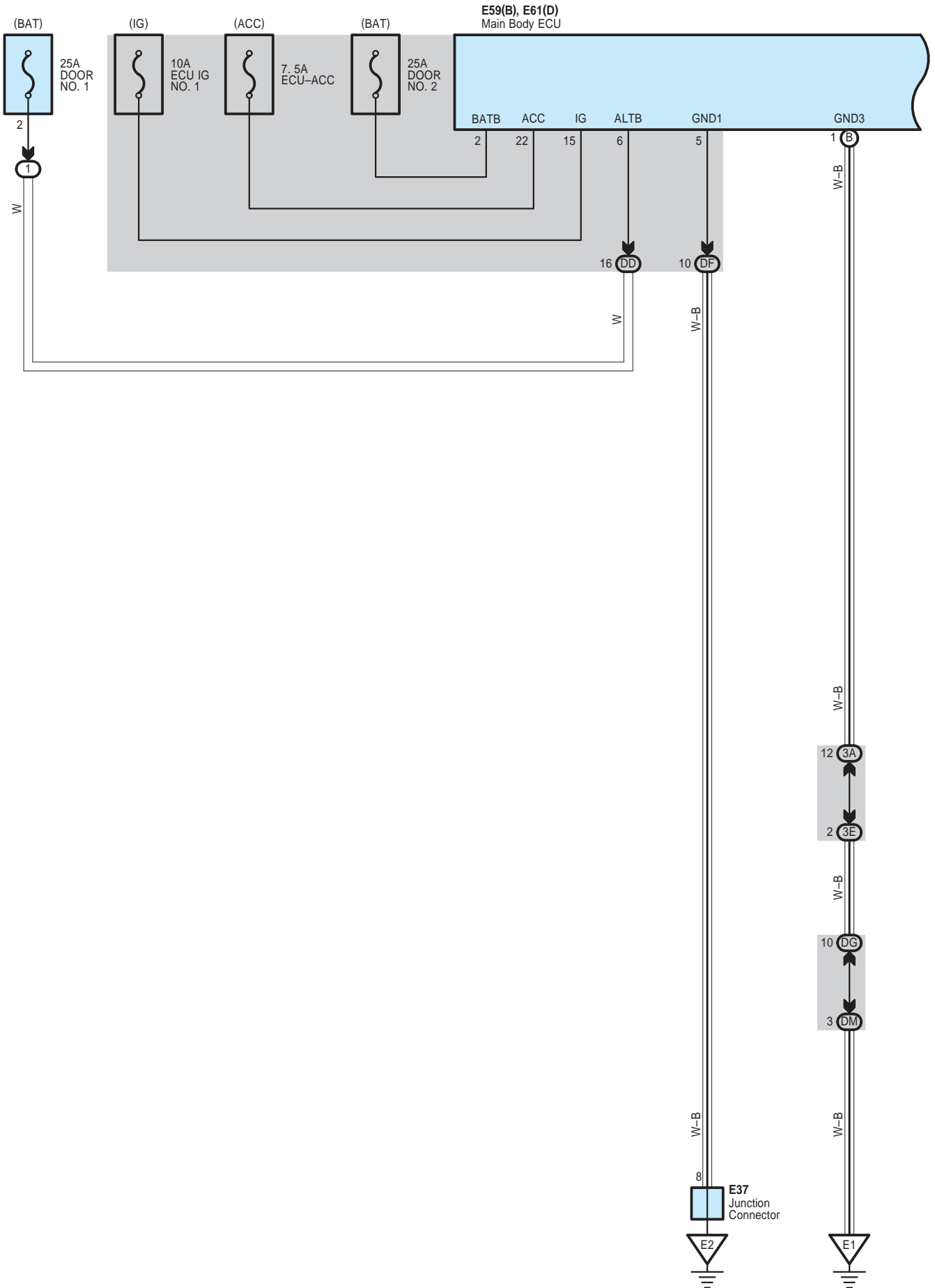

Power Window

E59(B), E61(D)
Main Body ECU

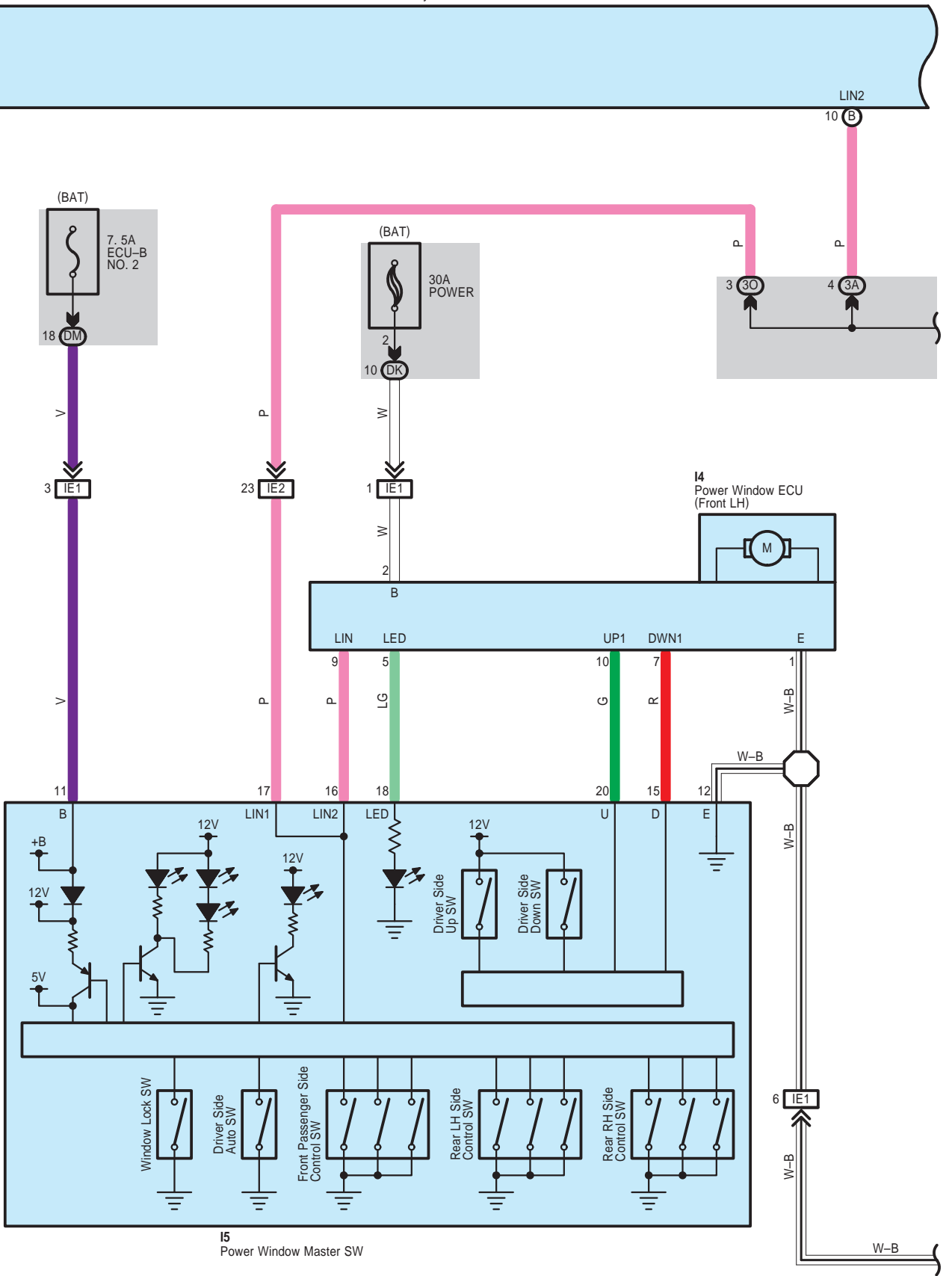

Power Window

E59(B), E61(D)
Main Body ECU

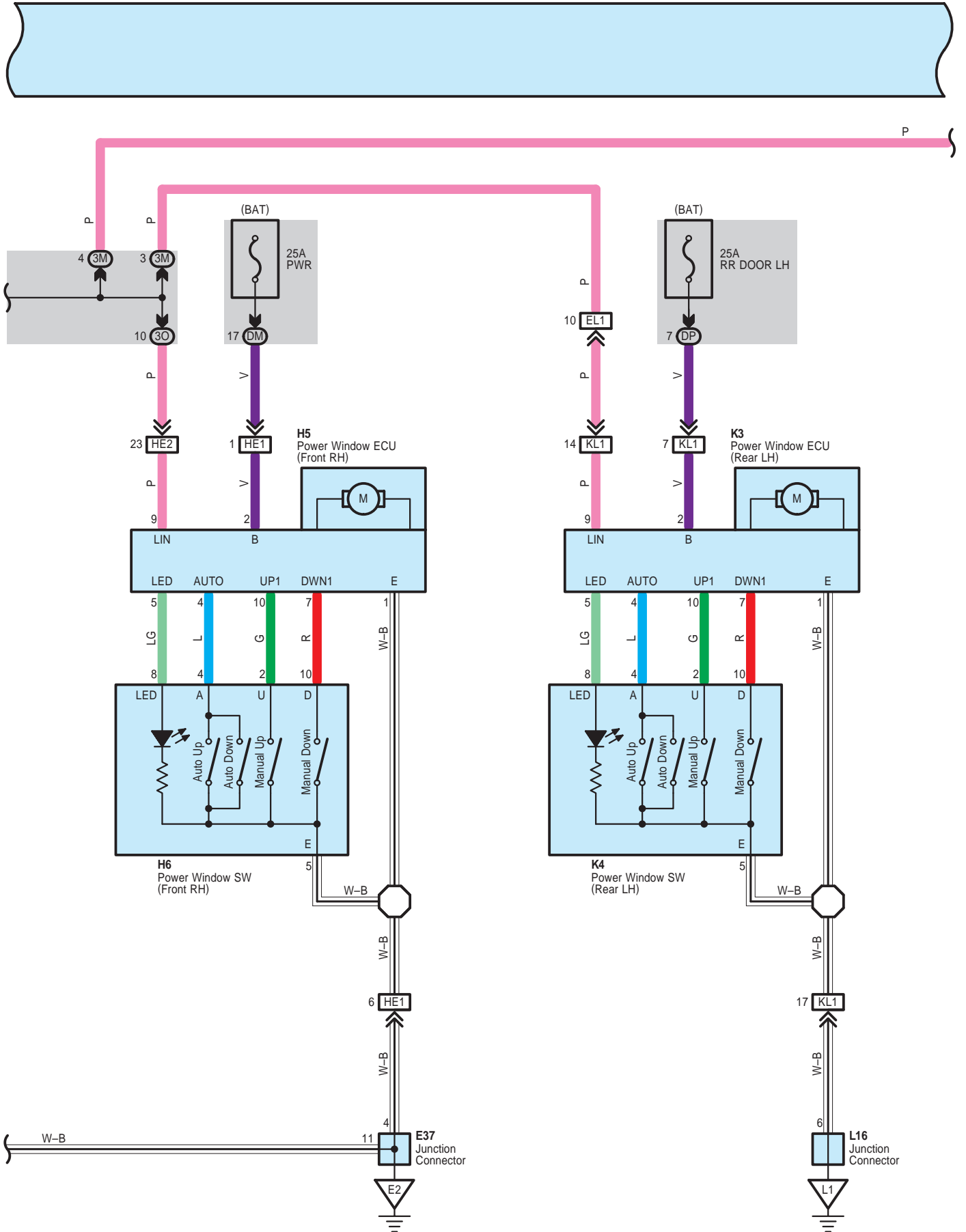

Power Window

E59(B), E61(D)
Main Body ECU

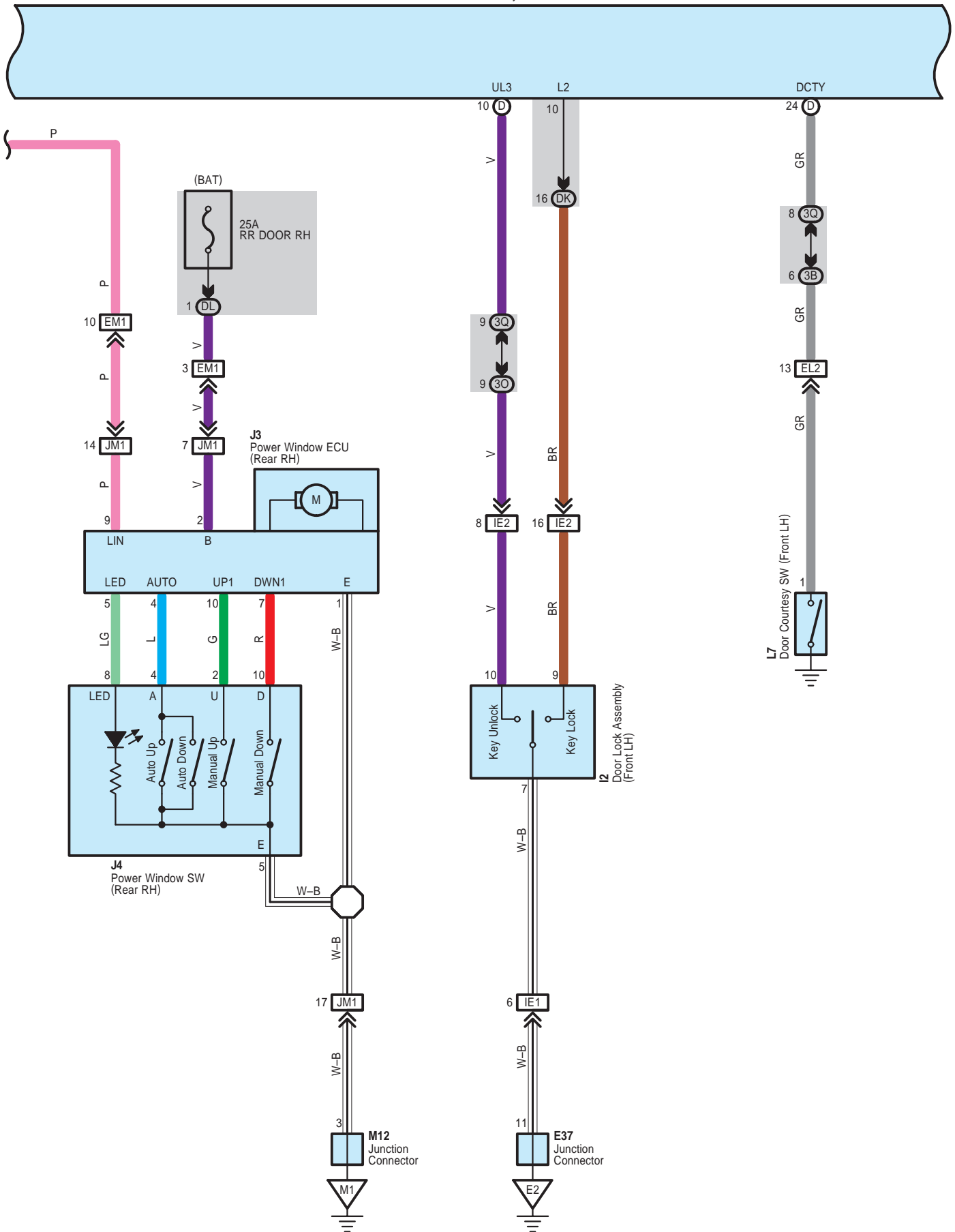

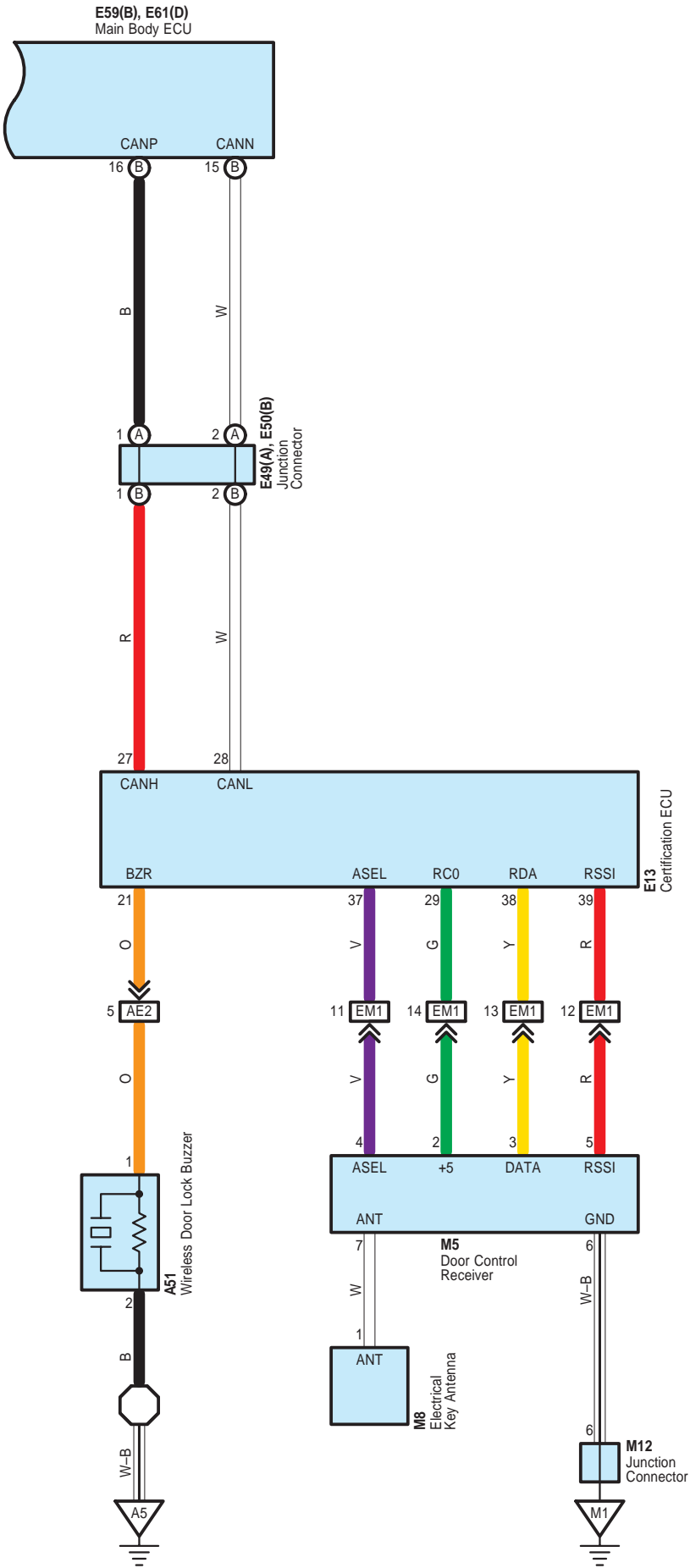

Power Window

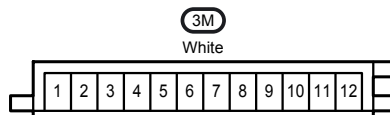
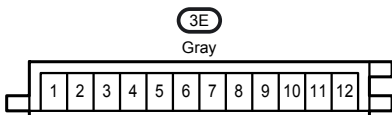
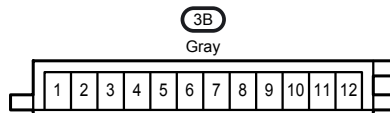
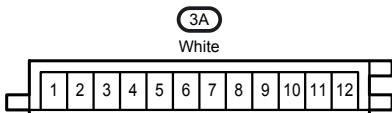
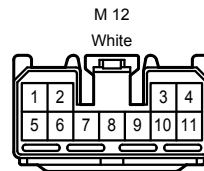
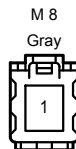
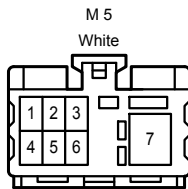
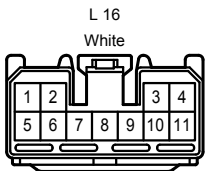
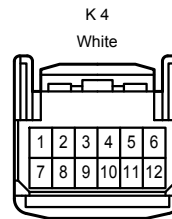
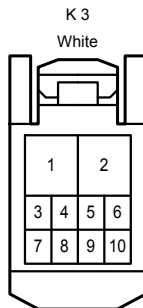
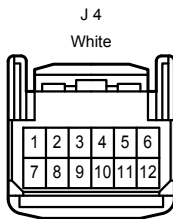
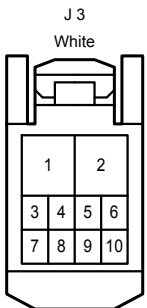
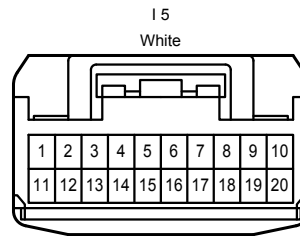
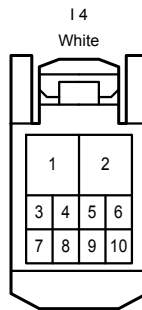
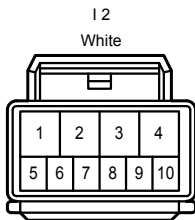
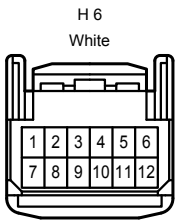
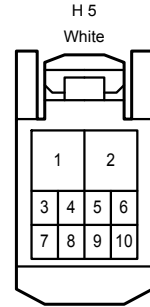
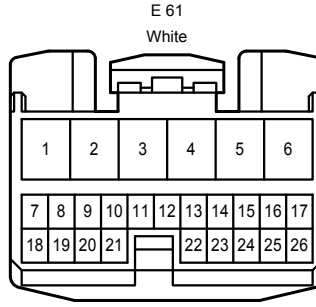
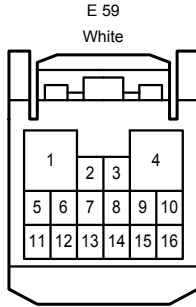
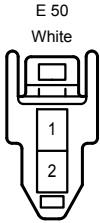
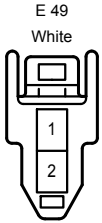
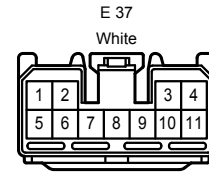
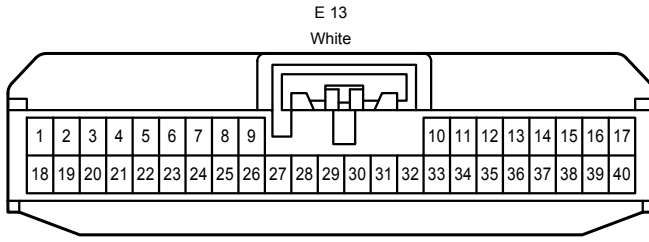
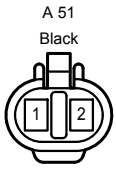

Power Window

3Q

Gray

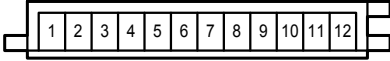

3Q

Gray

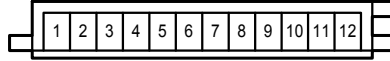

DD

White

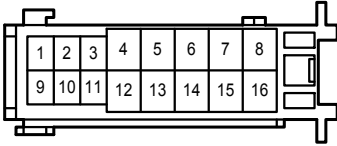

DF

White

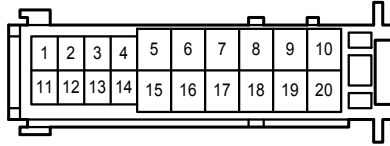

DG

White

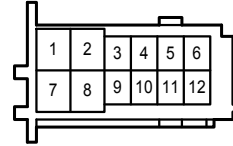

DK

White

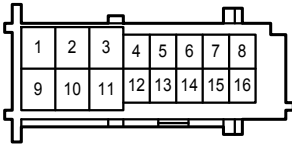

DL

White

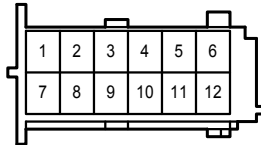

DM

White

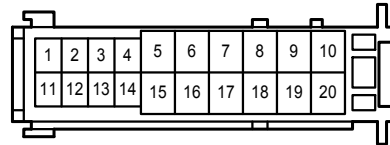

DP

White

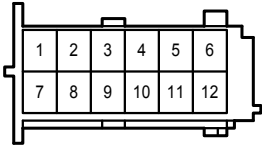

AE2

Gray

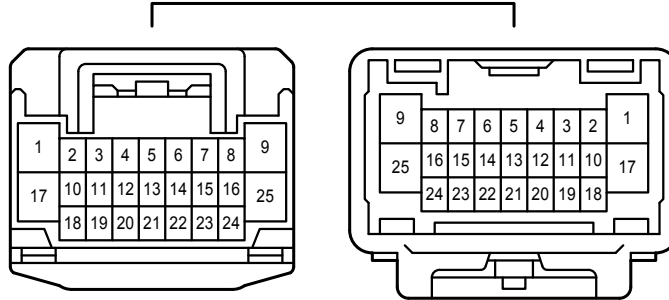

EL1

White

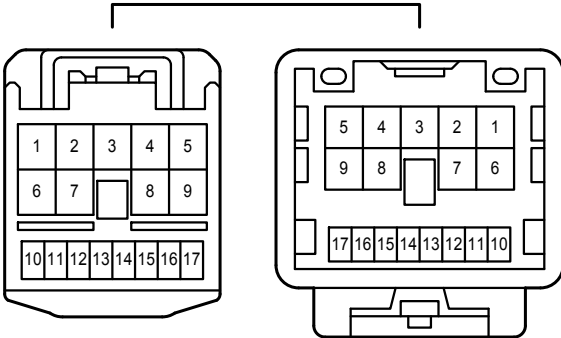

EL2

Blue

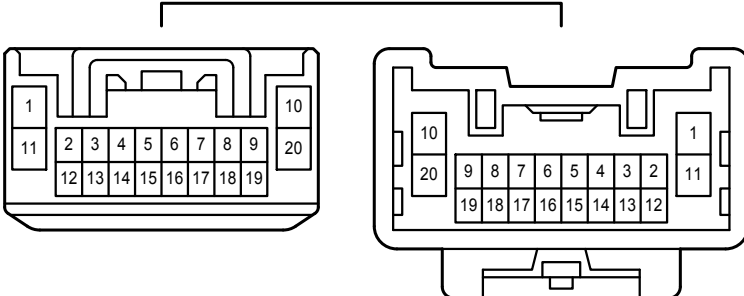

EM1
White

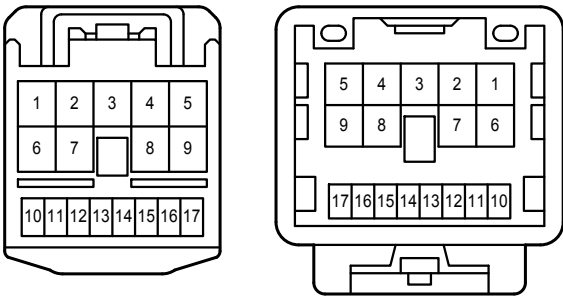

HE1
White

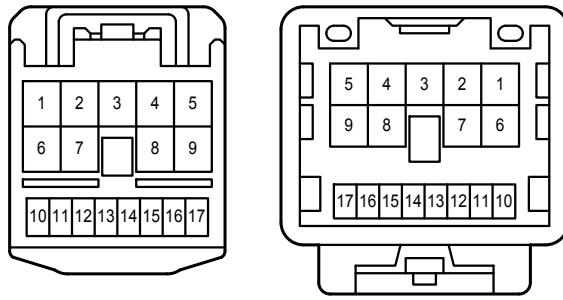

HE2
Gray

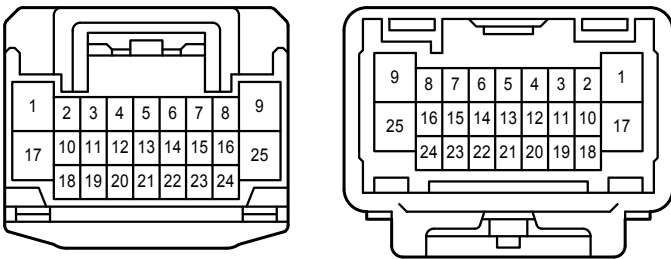

IE1
White

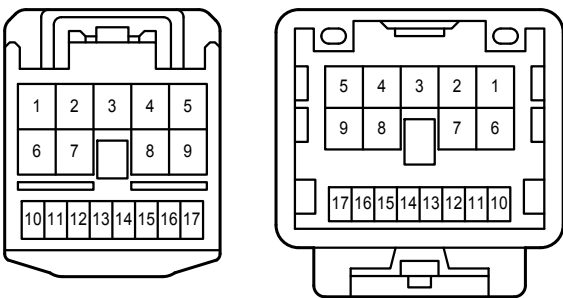

IE2
Gray

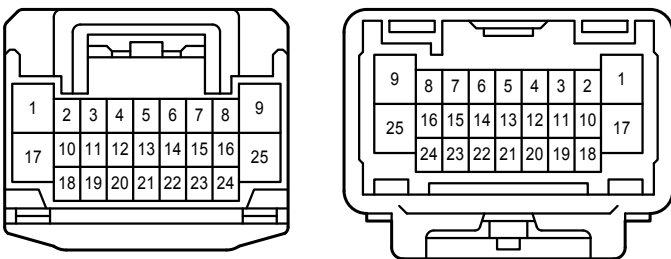

JM1
White

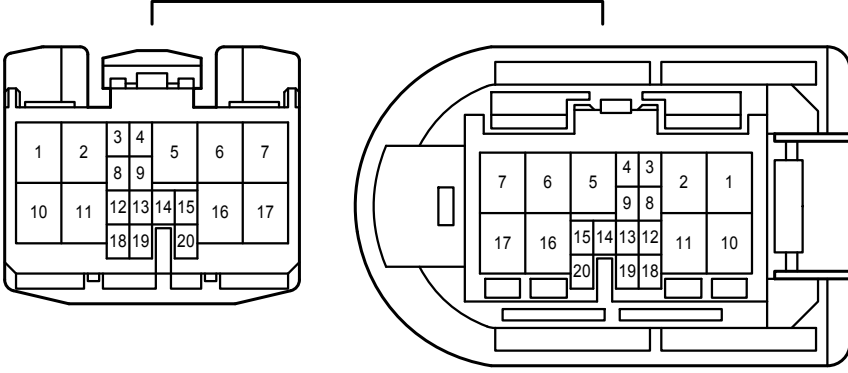

KL1
White

