

# RADIO AND PLAYER (NAKAMICHI)

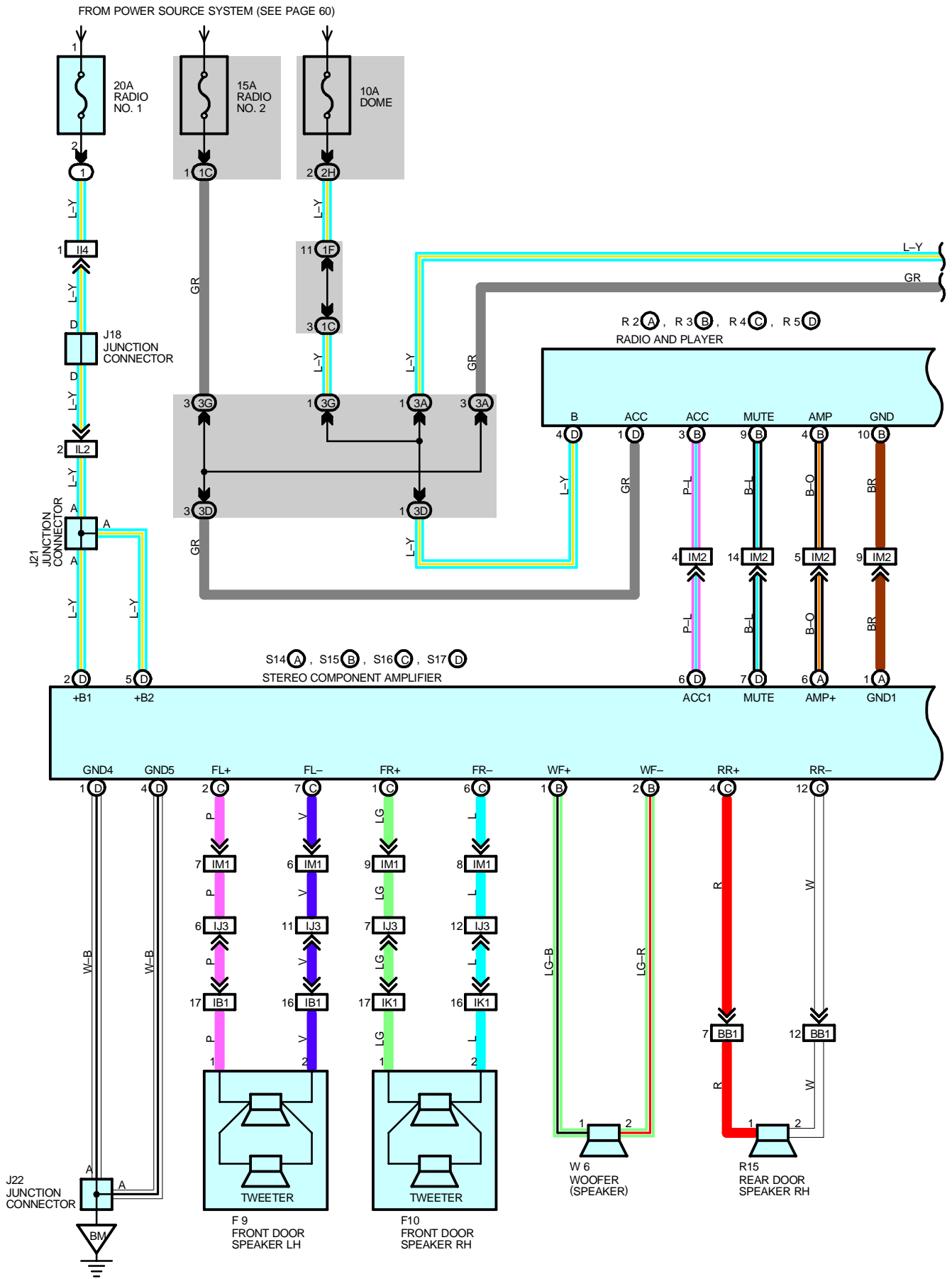

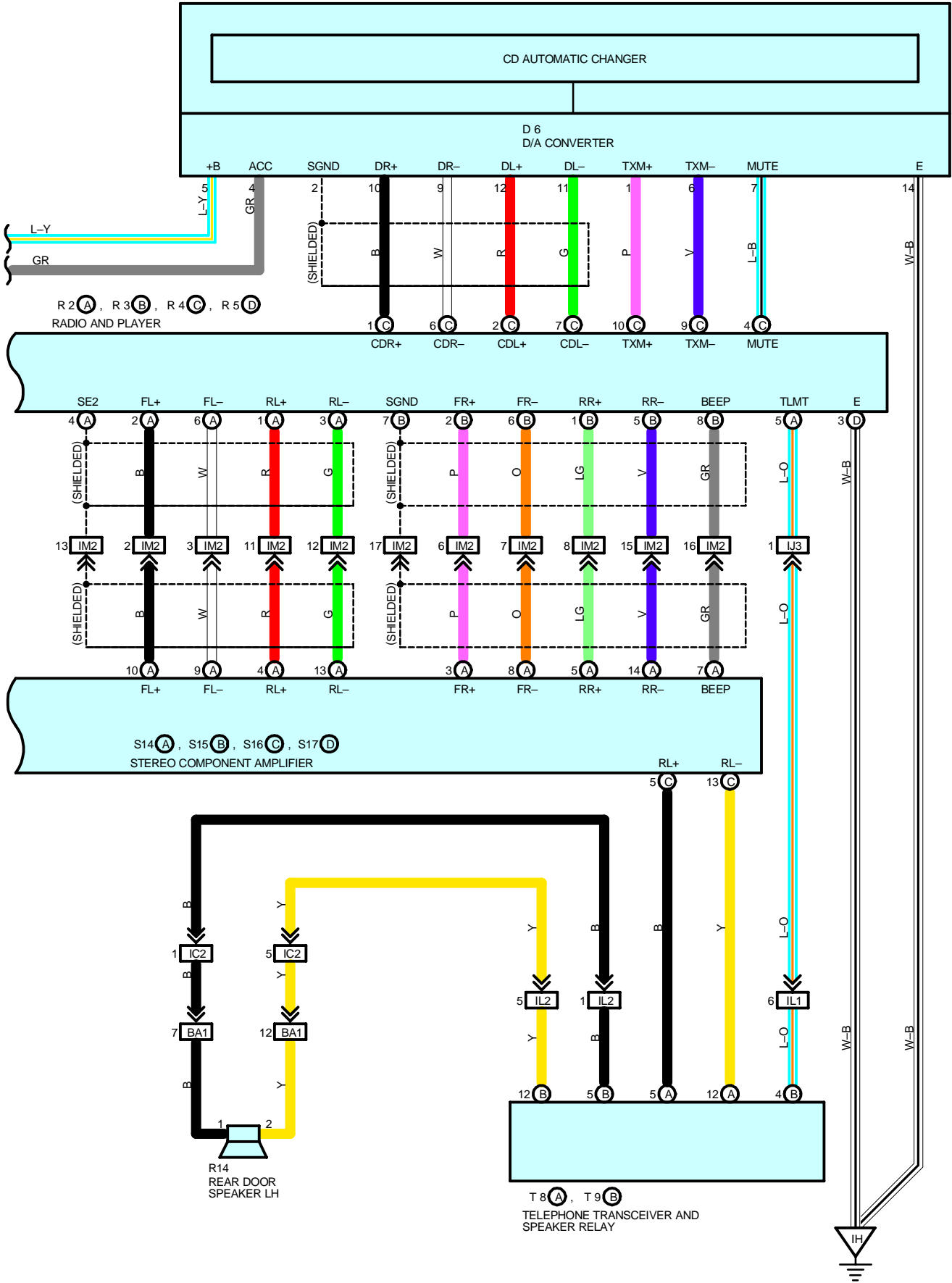

# RADIO AND PLAYER (NAKAMICHI)

## SERVICE HINTS

### R5 (D) RADIO AND PLAYER

(D) 1-GROUND : Approx. 12 volts with ignition SW at **ACC** or **ON** position

(D) 4-GROUND : Always approx. 12 volts

(D) 3-GROUND : Always continuity

### S17 (D) STEREO COMPONENT AMPLIFIER

(D) 2, (D) 5-GROUND : Always approx. 12 volts

(D) 1, (D) 4-GROUND : Always continuity

### D6 D/A CONVERTER

4-GROUND : Approx. 12 volts with ignition SW at **ACC** or **ON** position

5-GROUND : Always approx. 12 volts

## ○ : PARTS LOCATION

Code	See Page	Code	See Page	Code	See Page		
D 6	40	R3	B	41	S16	C	43
F9	42	R4	C	41	S17	D	43
F10	42	R5	D	41	T8	A	43
J18	41	R14		43	T9	B	43
J21	42	R15		43	W6		43
J22	42	S14	A	43			
R2	A	S15	B	43			

## ○ : RELAY BLOCKS

Code	See Page	Relay Blocks (Relay Block Location)
1	22	Engine Room No.1 R/B (Engine Compartment Right)

## ○ : JUNCTION BLOCK AND WIRE HARNESS CONNECTOR

Code	See Page	Junction Block and Wire Harness (Connector Location)
1C	26	Instrument Panel Wire and Driver Side J/B (Left Kick Panel)
1F	26	Cowl Wire and Driver Side J/B (Left Kick Panel)
2H	29	Cowl Wire and Passenger Side J/B (Right Kick Panel)
3A	30	Instrument Panel Wire and Instrument Panel J/B (Instrument Panel Reinforcement Center)
3D		
3G		

## □ : CONNECTOR JOINING WIRE HARNESS AND WIRE HARNESS

Code	See Page	Joining Wire Harness and Wire Harness (Connector Location)
IB1	50	Front Door LH Wire and Cowl Wire (Left Kick Panel)
IC2	50	Floor No.2 Wire and Cowl Wire (Left Kick Panel)
II4	52	Engine Room Main Wire and Cowl Wire (Near the Passenger Side R/B)
IJ3	52	Instrument Panel Wire and Cowl Wire (Left Side of the Blower Unit)
IK1	52	Front Door RH Wire and Cowl Wire (Right Kick Panel)
IL1	52	Floor No.1 Wire and Cowl Wire (Right Kick Panel)
IL2		
IM1	52	Instrument Panel Wire and Floor No.1 Wire (Front RH Side of the Shift Lever)
IM2		
BA1	54	Rear Door LH Wire and Floor No.2 Wire (Under the Center Pillar LH)
BB1	54	Rear Door RH Wire and Floor No.1 Wire (Under the Center Pillar RH)

## ▽ : GROUND POINTS

Code	See Page	Ground Points Location
IH	50	Instrument Panel Brace RH
BM	54	Quarter Panel RH

**D6**

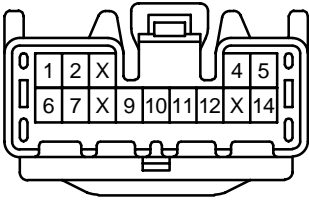

**F9**



**F10**



**J18**  
BLUE

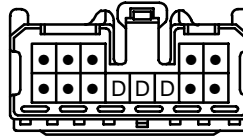

(Hint : See Page 7)

**J21**  
BLACK



(Hint : See Page 7)

**J22**

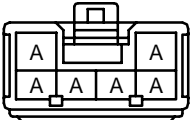

(Hint : See Page 7)

**R2 (A)**

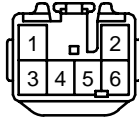

**R3 (B)**

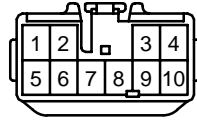

**R4 (C)**

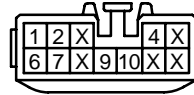

**R5 (D)**  
ORANGE

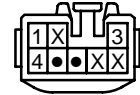

**R14**



**R15**



**S14 (A)**

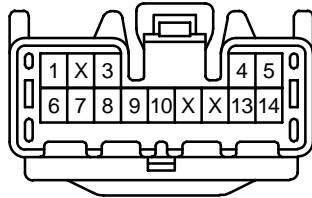

**S15 (B)**  
GRAY

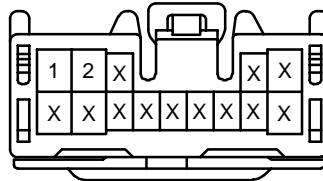

**S16 (C)**  
GREEN

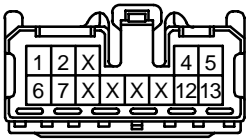

**S17 (D)**  
ORANGE

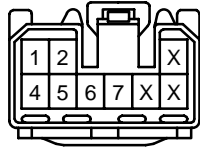

**T8 (A)**

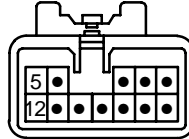

**T9 (B)**

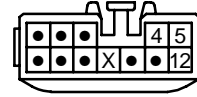

**W6**

