

PRE-CHECK

1. DIAGNOSIS SYSTEM

- (a) Check the warning lights and buzzer.
 - (1) Release parking brake pedal.
 - (2) When the ignition switch is turned ON, check that the ABS and BRAKE warning lights goes on for 3 seconds.
 - (3) When depressing the brake pedal repeatedly it may turn on the warning lights and buzzer.

HINT:

If the indicator check result is not normal, proceed to troubleshooting for the ABS warning light circuit (See page [DI-484](#)).

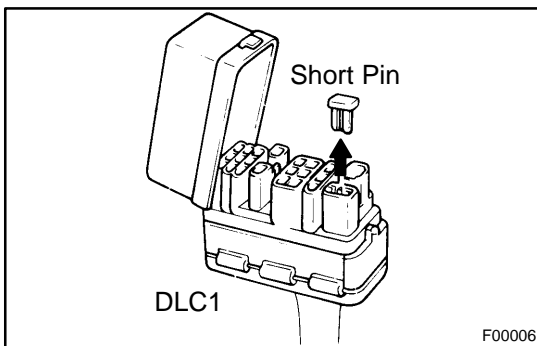

- (b) In case of not using LEXUS hand-held tester :
Check the DTC.
 - (1) Disconnect the short pin from DLC1.

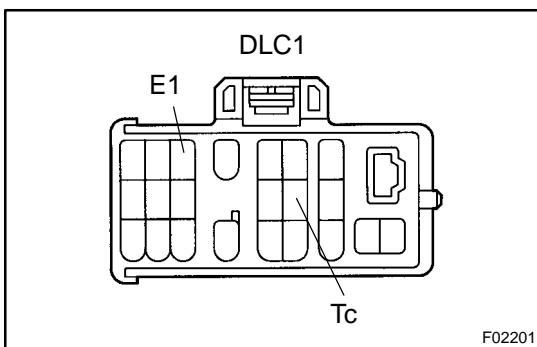

- (2) Using SST, connect terminals Tc and E₁ of DLC1.
SST 09843 – 18020
- (3) Turn the ignition switch ON.
- (4) Read the DTC from the ABS warning light on the combination meter.

HINT:

- If no code appears, inspect the diagnostic circuit or ABS warning light circuit (See page [DI-493](#) or [DI-484](#)).

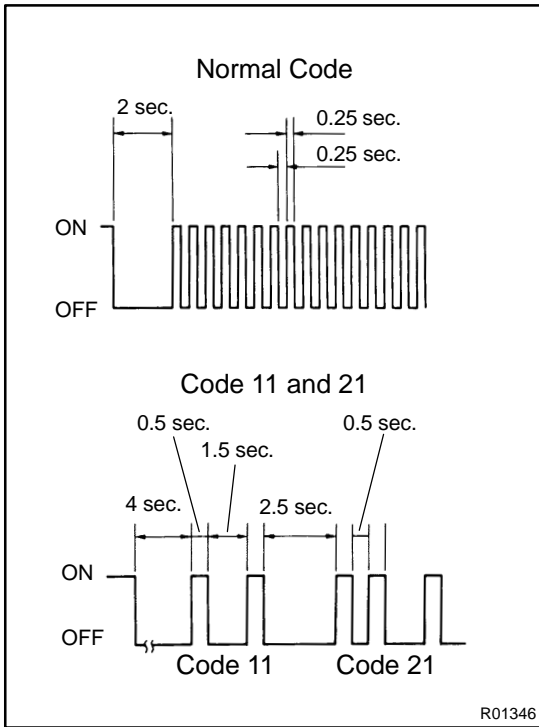

- As an example, the blinking patterns for normal code and codes 11 and 21 are shown on the left.
- (5) Codes are explained in the code table on page [DI-418](#).
- (6) After completing the check, disconnect terminals Tc and E₁, and turn off the display.

If 2 or more malfunctions are indicated at the same time the lowest numbered DTC will be displayed 1st.

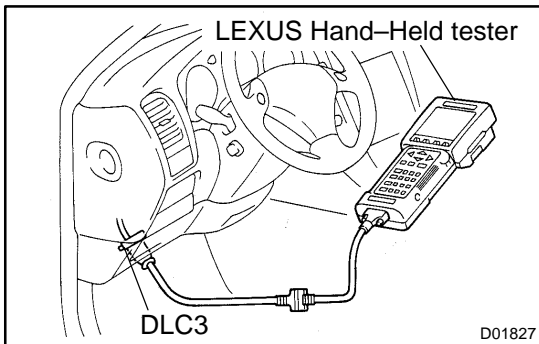

- (c) In case of not using LEXUS hand-held tester :
Check the DTC.

- Hook up the LEXUS hand-held tester to the DLC3.
- Read the DTC by following the prompts on the tester screen.

HINT:

Please refer to the LEXUS hand-held tester operator's manual for further details.

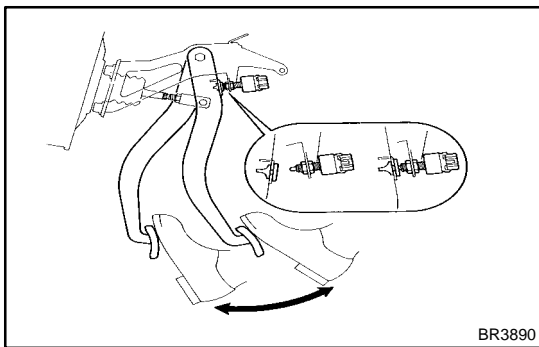

- (d) In case of not using LEXUS hand-held tester :
Clear the DTC.

- Using SST, connect terminals Tc and E₁ of DLC1 and remove the short pin from DLC1.

SST 09843 – 18020

- Turn the ignition switch ON.
- Clear the DTC stored in ECU by depressing the brake pedal 8 or more times within 5 seconds.
- Check that the warning light shows the normal code.

- Remove the SST from the terminals of DLC1.

SST 09843 – 18020

- Connect the short pin to DLC1.

HINT:

Disconnecting the battery cable during repairs will not erase the DTC in the ECU.

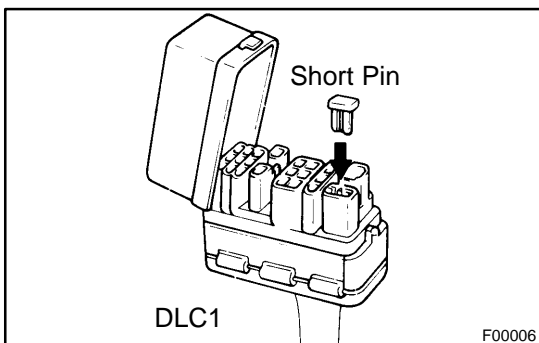

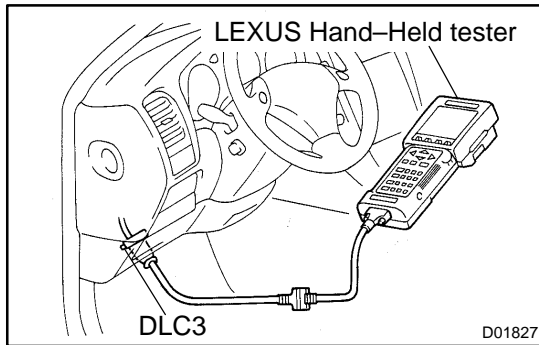

- (e) In case of using LEXUS hand-held tester :
- Clear the DTC.
- (1) Hook up the LEXUS hand-held tester to the DLC3.
 - (2) Turn the ignition switch ON.
 - (3) Operate the LEXUS hand-held tester to erase the codes.
- (See LEXUS hand-held tester operator's manual.)

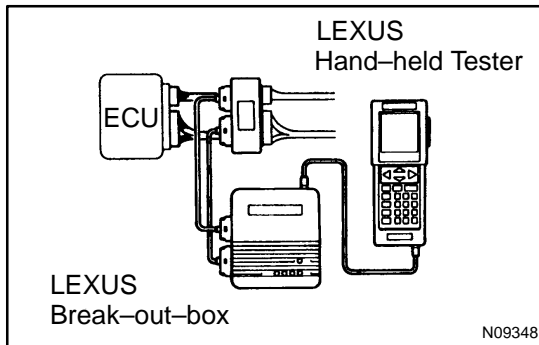

- (f) (Reference):
- Using LEXUS break-out-box and LEXUS hand-held tester, measure the ECU terminal values.
- (1) Turn the ignition switch OFF.
 - (2) Hook up the LEXUS break-out-box and LEXUS hand-held tester to the vehicle.
 - (3) Turn the ignition switch ON.
 - (4) Read the ECU input/output values by following the prompts on the tester screen.

HINT:

- LEXUS hand-held tester has a "Snapshot" function. This records the measured values and is effective in the diagnosis of intermittent problems.
- Please refer to the LEXUS hand-held tester/LEXUS break-out-box operator's manual for further details.

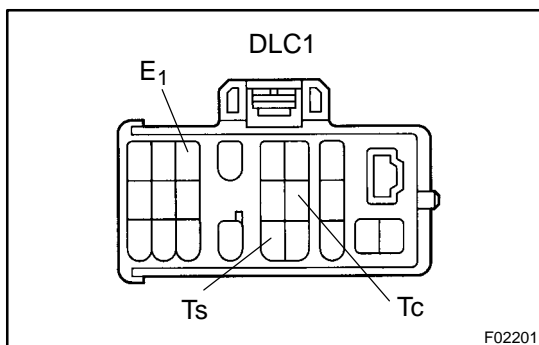

2. SENSOR SIGNAL CHECK (TEST MODE)

HINT:

If the ignition switch is turned from ON to ACC or LOCK during test mode, DTC will be erased.

- (a) In case of not using LEXUS hand-held tester:
- Check the sensor signal.
- (1) Turn the ignition switch OFF.
 - (2) Using SST, connect terminals Ts and E₁ of DLC1.
- SST 09843 – 18020
- (3) Start the engine.
 - (4) Check that the ABS warning light blinks.

HINT:

If the ABS warning light does not blink, inspect the ABS warning light circuit and Ts circuit (See page [DI-484](#), [DI-495](#)).

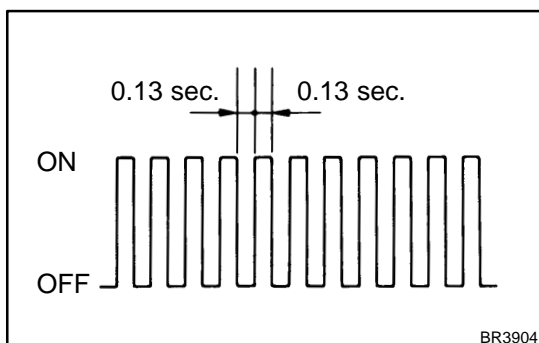

- (5) Keep the vehicle in the stationary condition on the flat place for 1 sec. or more.
- (6) Leaving the vehicle in the stationary condition and the brake pedal in free condition for 1 sec. or more, continue to depress the brake pedal with 98 N (10 kgf, 22 lbf) of force or more for 1 sec. or more.

- (7) Leaving the vehicle in the stationary condition, depress the brake pedal with 980 N (100 kgf, 221 lbf) of force or more quickly.

HINT:

At this time, the ABS warning light comes on for 3 sec.

- (8) Drive vehicle straight forward.
When driving the vehicle with the speed faster than 45 km/h (28 mph) for several seconds, check that the ABS warning light comes off.

HINT:

There is a case that the sensor check is not completed if the vehicle has its rear wheels spun or its steering wheel steered during this check.

- (9) Stop the vehicle.
- (10) Using SST, connect terminals Tc and E₁ of DLC1.
SST 09843 – 18020
- (11) Read the number of blinks of the ABS warning light.

HINT:

- See the list of DTC on step (C).
 - If every sensor is normal, a normal code is output (A cycle of 0.25 sec. ON and 0.25 sec. OFF is repeated).
 - If 2 or more malfunctions are indicated at the same time, the lowest numbered code will be displayed 1st.
- (12) After doing the check, disconnect terminals Ts and E₁, Tc and E₁ of DLC1, and turn the ignition switch OFF.

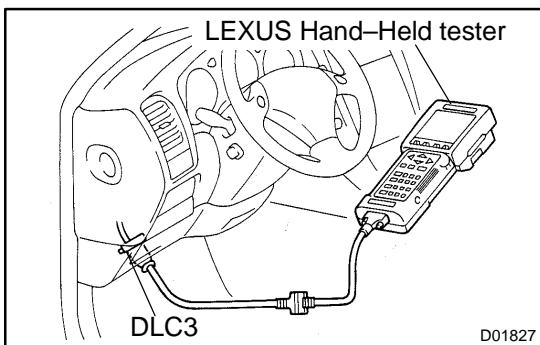
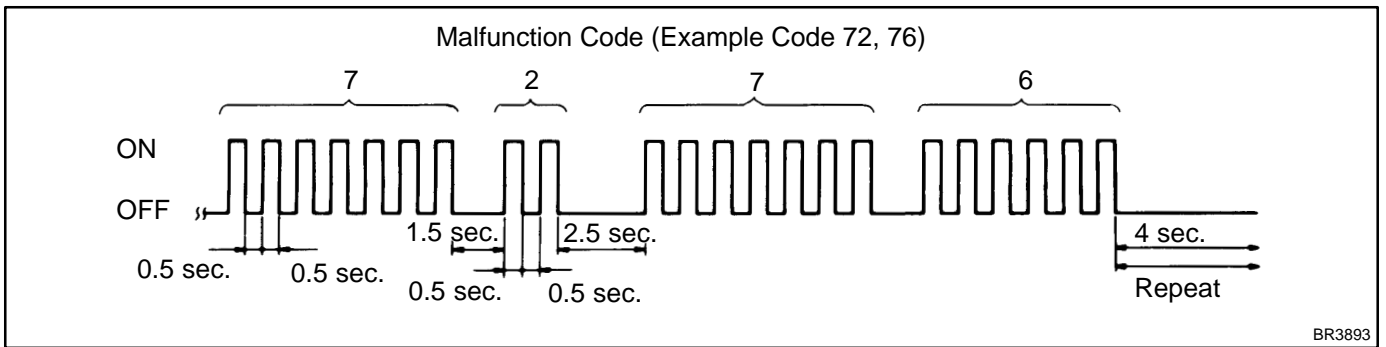

- (b) In case of using LEXUS hand-held tester :
Check the sensor signal.

 - (1) Hook up the LEXUS hand-held tester to the DLC3.
 - (2) Do step (3) to (9) on the previous page.
 - (3) Read the DTC by following the prompts on the tester screen.

HINT:

Please refer to the LEXUS hand-held tester operator's manual for further details.

(c) Check the DTC of the sensor function.

Code No.	Diagnosis	Trouble Area
C1271 / 71	Low output voltage of right front speed sensor	<ul style="list-style-type: none"> • Right front speed sensor • Sensor installation • Sensor rotor
C1272 / 72	Low output voltage of left front speed sensor	<ul style="list-style-type: none"> • Left front speed sensor • Sensor installation • Sensor rotor
C1273 / 73	Low output voltage of right rear speed sensor	<ul style="list-style-type: none"> • Right rear speed sensor • Sensor installation • Sensor rotor
C1274 / 74	Low output voltage of left rear speed sensor	<ul style="list-style-type: none"> • Left rear speed sensor • Sensor installation • Sensor rotor
C1275 / 75	Abnormal change in output voltage of right front speed sensor	<ul style="list-style-type: none"> • Right front speed sensor rotor
C1276 / 76	Abnormal change in output voltage of left front speed sensor	<ul style="list-style-type: none"> • Left front speed sensor rotor
C1277 / 77	Abnormal change in output voltage of right rear speed sensor	<ul style="list-style-type: none"> • Right rear speed sensor rotor
C1278 / 78	Abnormal change in output voltage of left rear speed sensor	<ul style="list-style-type: none"> • Left rear speed sensor rotor
C1279 / 79	Deceleration sensor is faulty	<ul style="list-style-type: none"> • Deceleration sensor • Sensor installation
C1281 / 81	Master cylinder pressure sensor output signal is faulty	<ul style="list-style-type: none"> • Master cylinder pressure sensor

**3. DECELERATION SENSOR OPERATION DIAGNOSIS
SYSTEM****CAUTION:**

While checking the deceleration sensor operating diagnosis system, ABS does not work and brake system works as a conventional brake system.

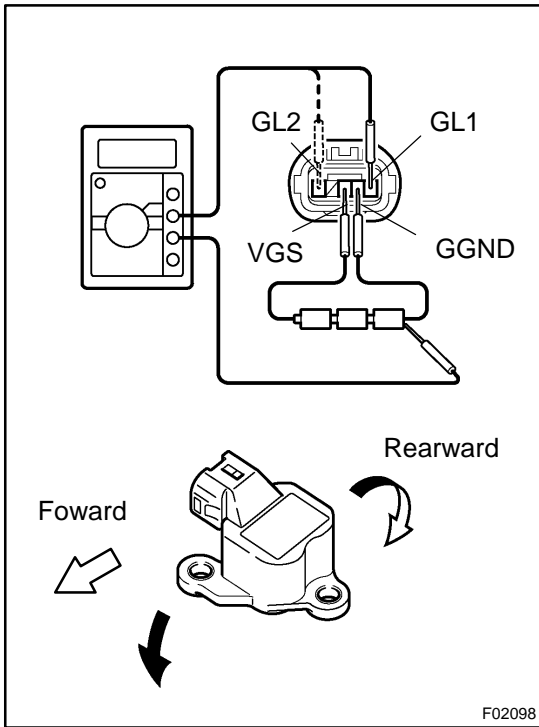

4. DECELERATION SENSOR CHECK

- (a) Connect 3 dry batteries of 1.5 V in series.
- (b) Connect VGS terminal to the batteries' positive (+) terminal, and GGND terminal to the batteries' negative (-) terminal, apply about 4.5 V between VGS and GGND terminals.

NOTICE:

Do not apply voltage of 6 V or more to terminals VGS and GGND.

- (c) Check the output voltage of GL1 and GL2 terminals.

Symbols	Condition	Standard Value
GL1	Horizontal	About 2.3 V
GL1	Lean forward	0.4 V – about 2.3 V
GL1	Lean rearward	About 2.3 V – 4.1 V
GL2	Horizontal	About 2.3 V
GL2	Lean forward	About 2.3 V – 4.1 v
GL2	Lean rearward	0.4 V – about 2.3 V

HINT:

- If the sensor is tilted too much it may show the wrong value.
- If dropped, the sensor should be replaced with a new one.
- The sensor removed from the vehicle should not be placed upside down.