

# Navigation Installation Guide

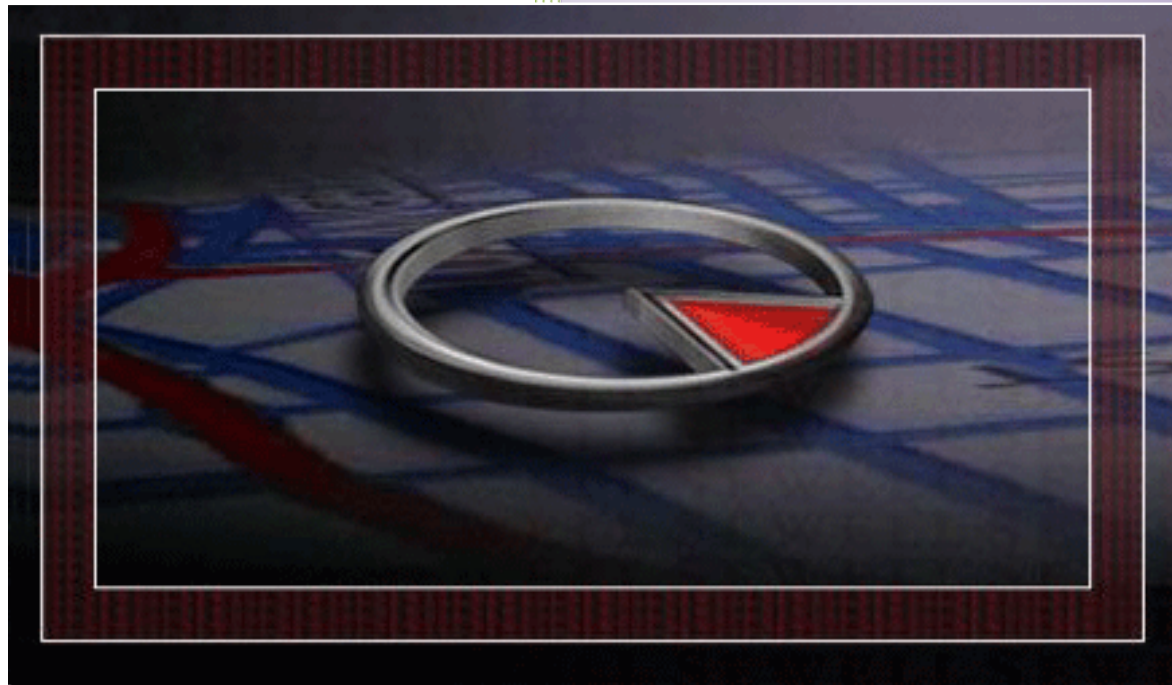

# ES 330

ES 330

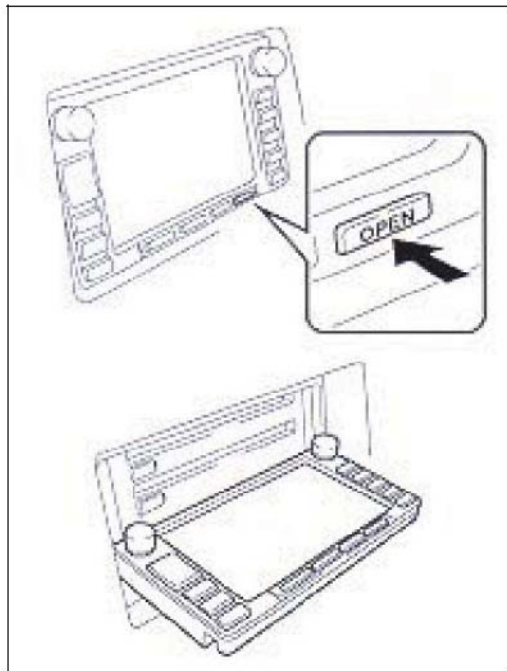
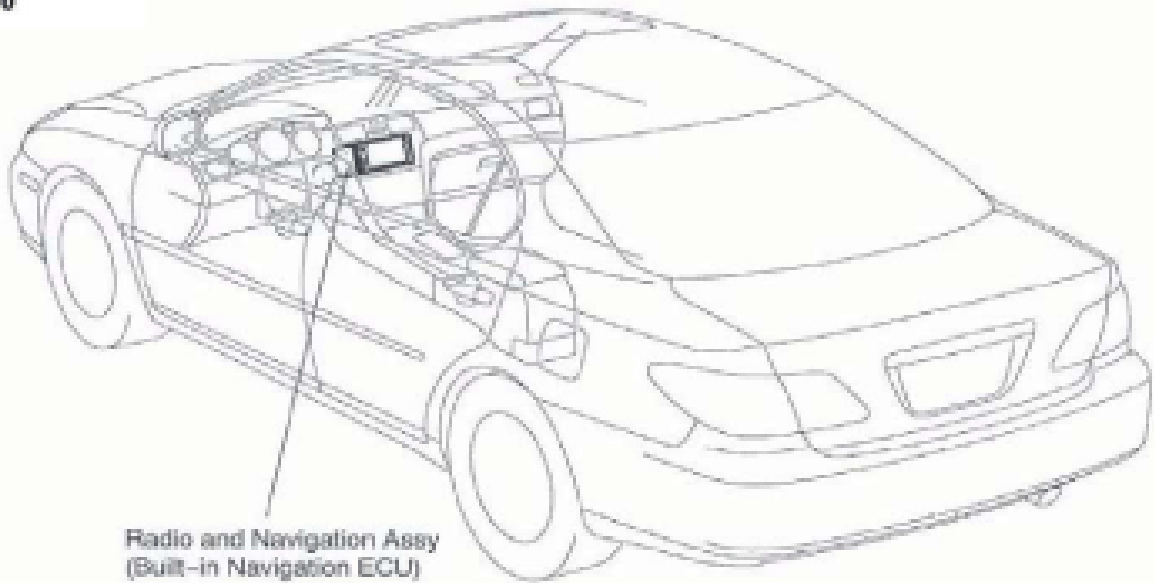

1. TURN THE IGNITION SWITCH TO THE "ACC" OR "ON" POSITION.
2. PRESS THE "OPEN" BUTTON TO TILT THE NAVIGATION DISPLAY.
3. PRESS THE "MAP" BUTTON TO REMOVE THE OLD NAVIGATION DVD.
4. REMOVE AND DISCARD THE OLD DVD, OR IF ELIGIBLE, RETURN FOR REBATE.
5. INSERT THE NEW NAVIGATION DVD.
6. PUSH THE "OPEN" BUTTON AGAIN TO CLOSE THE DISPLAY PANEL.
7. THE NAVIGATION SYSTEM SHOULD NOW UPDATE AUTOMATICALLY.

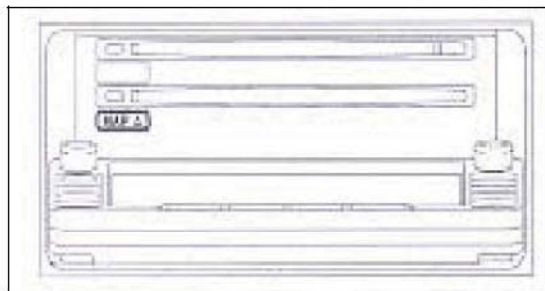

# LS 430

LS430

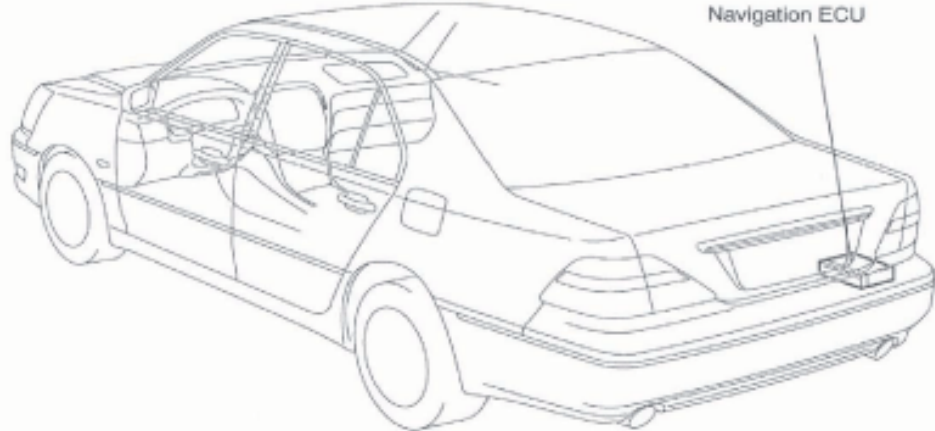

## 1. REMOVE THE LUGGAGE COMPARTMENT FLOOR MAT.

- I. REMOVE THE FLOOR MAT
- II. REMOVE THE 2 BOLTS AND THE 2 LUGGAGE COMPARTMENT TRIM HOOKS.
- III. REMOVE THE 2 CLIPS AND 2 DECK SIDE TRIM BOARDS.

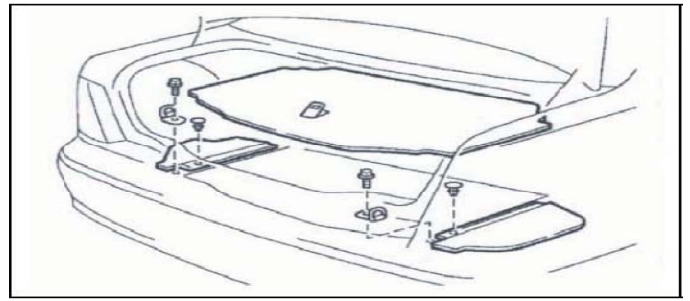

## 2. REMOVE THE REAR FLOOR FINISH PLATE.

- I. REMOVE THE 5 CLIPS.
- II. DISENGAGE THE 4 CLIPS AND REMOVE PLATE A

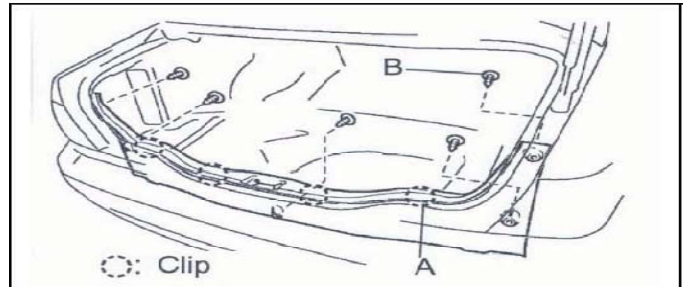

## 3. REMOVE THE NAVIGATION ECU

- I. REMOVE THE 2 SCREWS
- II. RAISE THE FRONT PORTION OF THE NAVIGATION ECU

## 4. REPLACE THE NAVIGATION DVD

- I. TURN THE IGNITION SWITCH TO THE "ACC" OR "ON" POSITION.
- II. PRESS THE "PUSH" BUTTON AND SLIDE IT TO THE LEFT. THIS WILL OPEN THE DUST COVER AND EJECT THE DVD.
- III. REMOVE AND DISCARD THE OLD DVD, OR IF ELIGIBLE, RETURN FOR REBATE.
- IV. INSERT THE NEW NAVIGATION DVD.
- V. PRESS THE "PUSH" BUTTON AND SLIDE IT TO THE RIGHT. THIS WILL CLOSE THE DUST COVER.

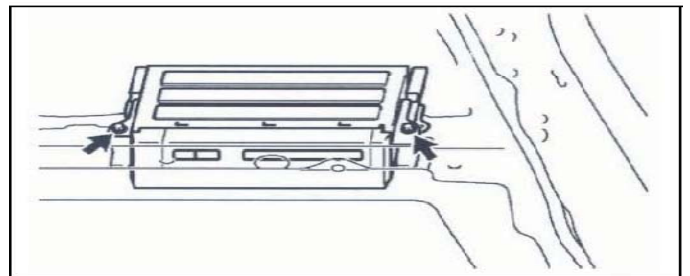

## 5. REINSTALL THE NAVIGATION ECU

- I. COMPLETE STEPS 1-3 IN REVERSE TO INSTALL ECU.

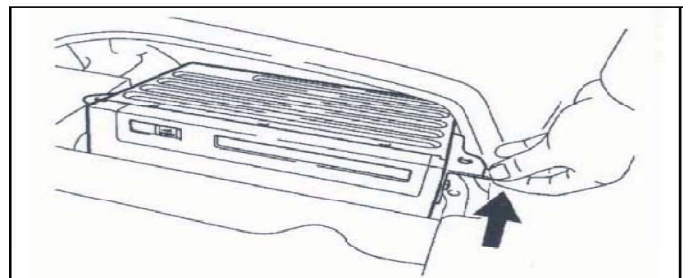

## 6. YOUR NAVIGATION SYSTEM SHOULD NOW UPDATE AUTOMATICALLY.

# LX 470

LX 470:

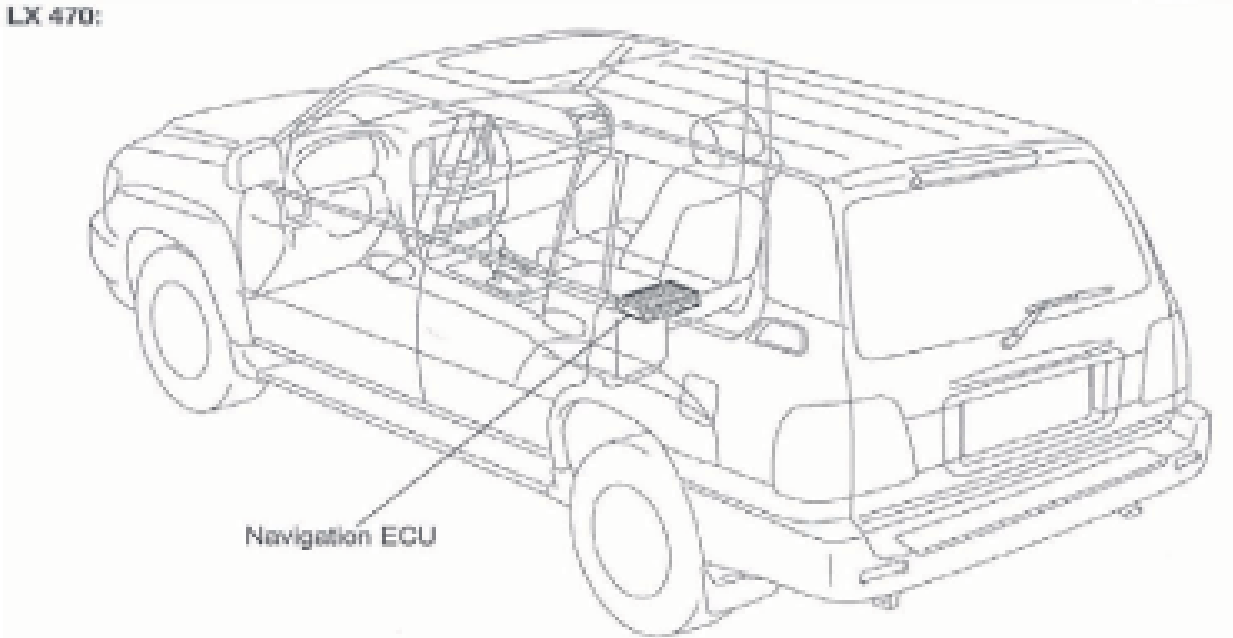

1. **REMOVE THE NAVIGATION ECU COVER**
  - I. MOVE THE FRONT PASSENGER SEAT TO ITS MOST FORWARD POSITION
  - II. DISENGAGE THE 2 SCREWS AND REMOVE THE NAVIGATION ECU COVER.
  
2. **REPLACE THE NAVIGATION DVD.**
  - I. TURN THE IGNITION SWITCH TO THE "ACC" OR "ON" POSITION.
  - II. PRESS THE "PUSH" BUTTON AND SLIDE IT TO THE LEFT. THIS WILL OPEN THE DUST COVER AND EJECT THE DVD.
  - III. REMOVE AND DISCARD THE OLD DVD, OR IF ELIGIBLE, RETURN FOR REBATE.
  - IV. INSERT THE NEW NAVIGATION DVD.
  - V. PRESS THE "PUSH" BUTTON AND SLIDE IT TO THE RIGHT. THIS WILL CLOSE THE DUST COVER.
  
3. **REINSTALL THE NAVIGATION ECU COVER IN THE SAME MANNER IT WAS REMOVED.**

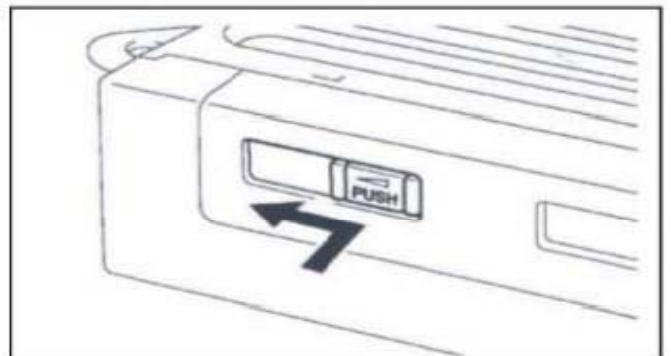
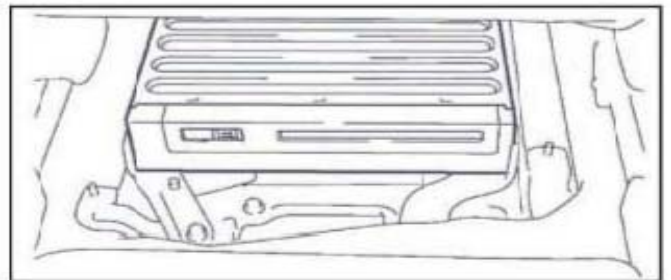
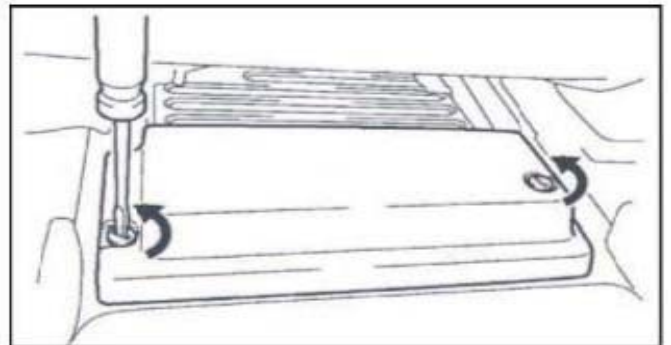

# RX 330

RX 330:

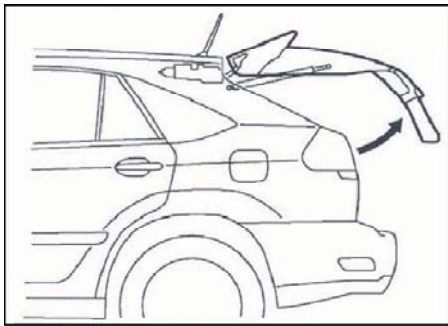
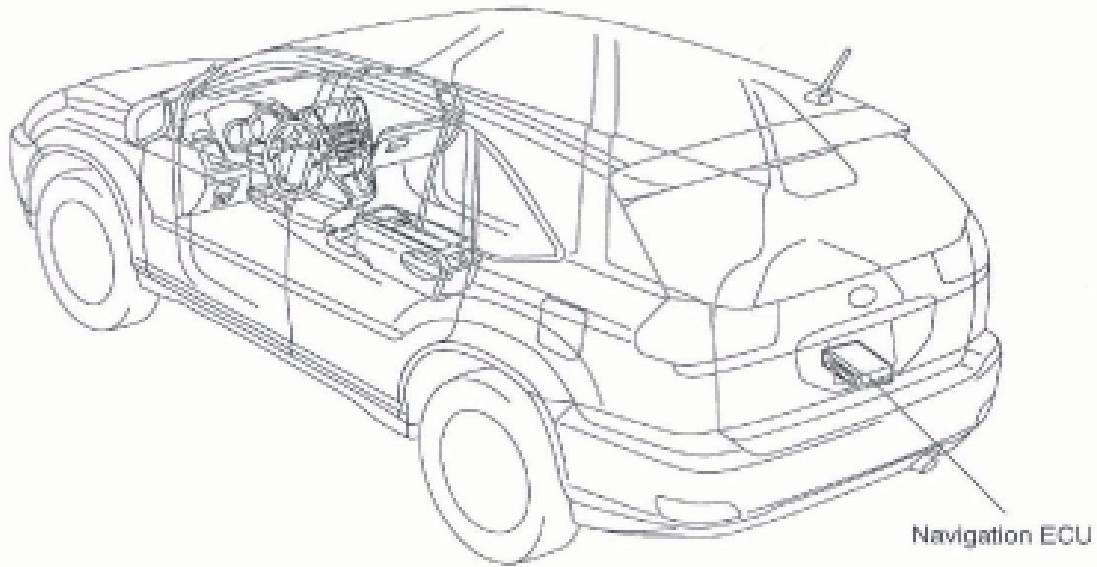

1. TURN THE IGNITION SWITCH TO THE "ACC" OR "ON" POSITION.
2. OPEN THE REAR HATCH.

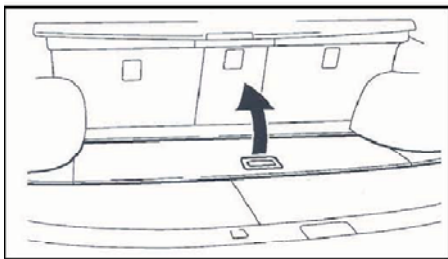

3. OPEN THE DECK BOARD SUB-ASSEMBLY.
4. SUPPORT THE DECK BOARD VIA THE SUPPORTING ROD.

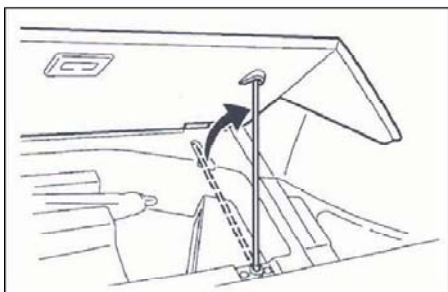

5. DISENGAGE THE 2 CLAWS.
6. REMOVE THE NAVIGATION ECU COVER.
7. PRESS THE "PUSH" BUTTON AND SLIDE IT TO THE LEFT. THIS WILL OPEN THE DUST COVER AND EJECT THE DVD.
8. REMOVE AND DISCARD THE OLD DVD, OR IF ELIGIBLE, RETURN FOR REBATE.
9. INSERT NEW NAVIGATION DVD.
10. NAVIGATION DISC SHOULD UPDATE AUTOMATICALLY.

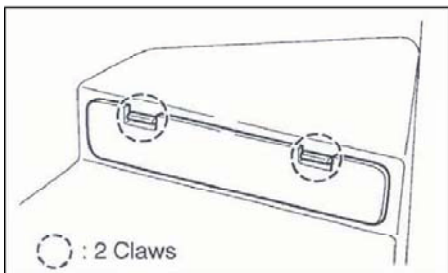

# SC 430

SC 430:

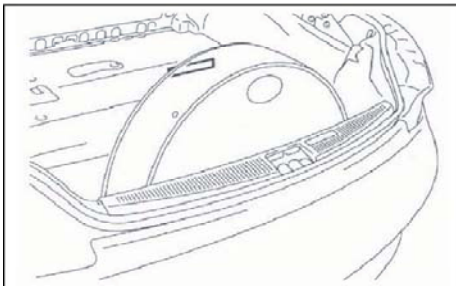
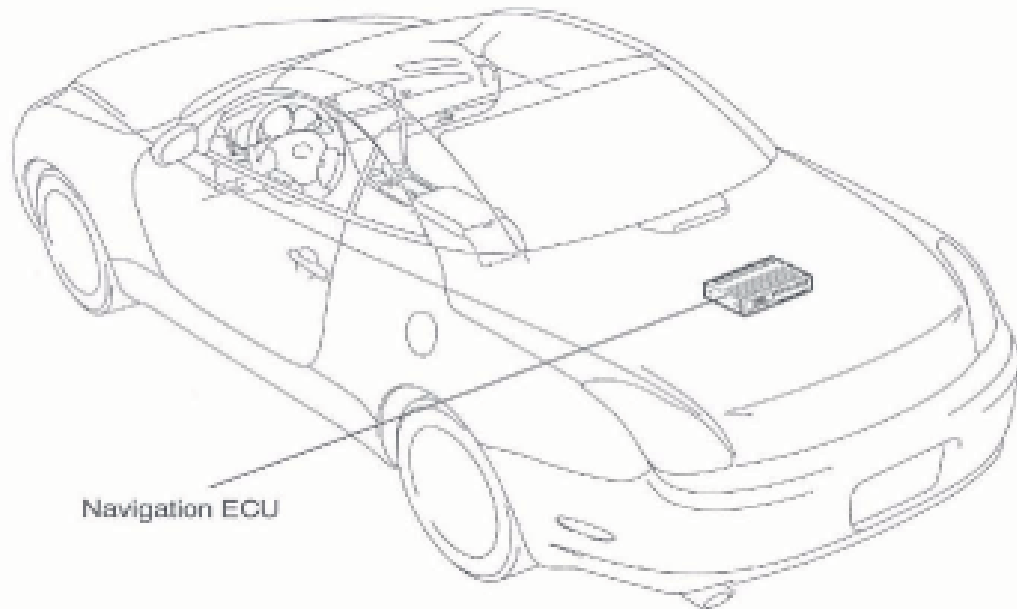

1. TURN THE IGNITION SWITCH TO THE "ACC" OR "ON" POSITION.
2. OPEN THE LUGGAGE COMPARTMENT.

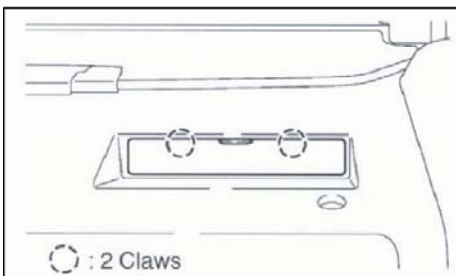

3. DISENGAGE THE 2 CLAWS
4. REMOVE THE NAVIGATION ECU COVER.
5. PRESS THE PUSH BUTTON AND SLIDE IT TO THE LEFT. THIS WILL OPEN THE DUST COVER AND EJECT THE DVD.

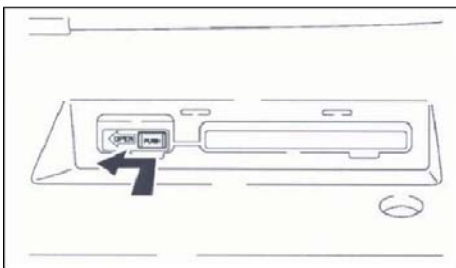

6. REMOVE AND DISCARD THE OLD DVD, OR IF ELIGIBLE RETURN FOR REBATE.

7. INSERT THE NEW NAVIGATION DVD.
8. NAVIGATION SYSTEM SHOULD NOW UPDATE AUTOMATICALLY.

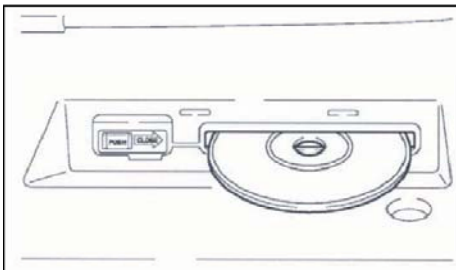

# GS 300/350/430/460

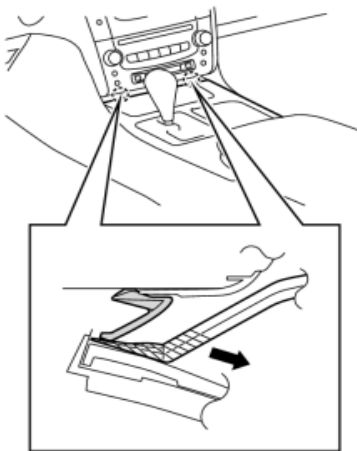
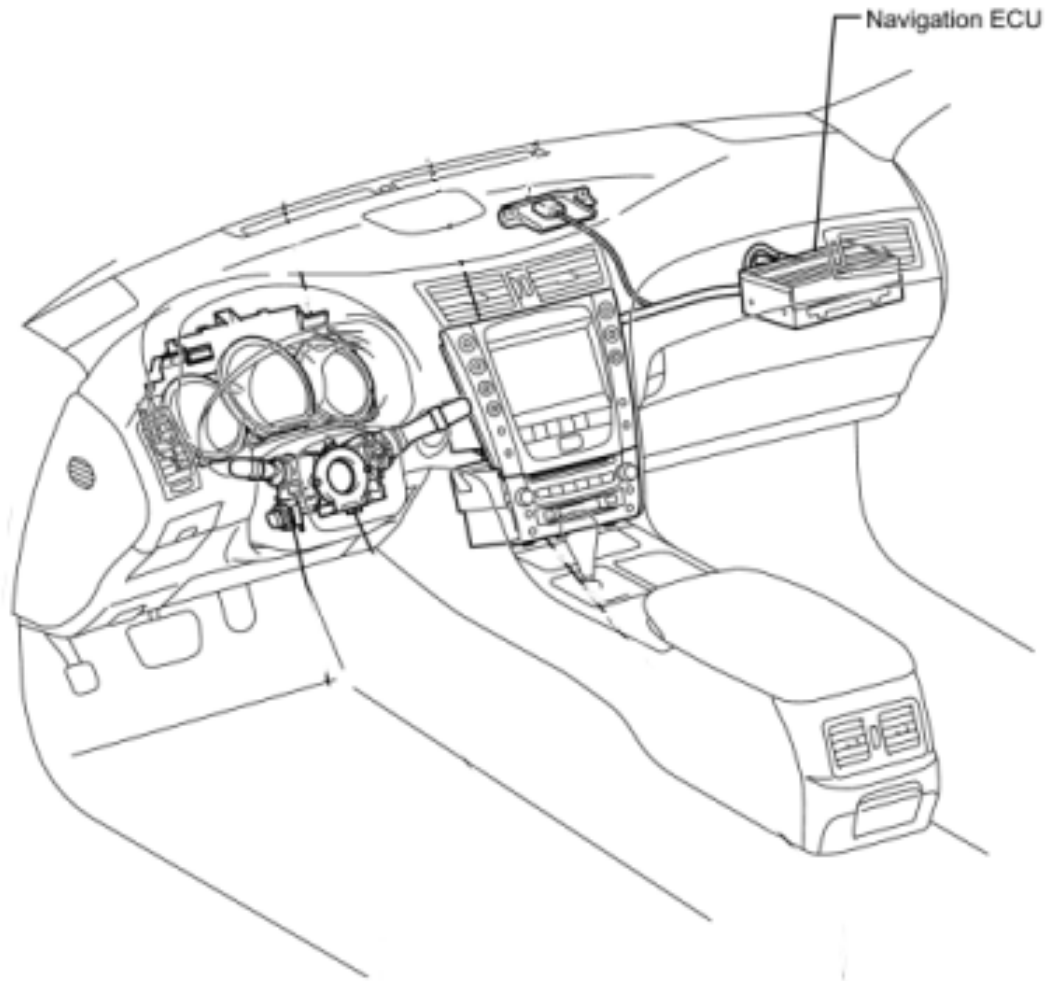

## 1. REMOVE FRONT CONSOLE UPPER PANEL GARNISH.

- A. USING A CLIP REMOVER, DETACH THE CLAWS AND REMOVE THE GARNISH.

## 2. REMOVE CONSOLE UPPER PANEL ASSEMBLY

- A. TWIST THE SHIFT LEVER KNOB IN THE DIRECTION INDICATED BY THE ARROW AND REMOVE IT.
- B. USING A SCREWDRIVER, DETACH THE 9 CLIPS.
- C. REMOVE THE ASH RECEPTACLE AND THEN DISCONNECT THE CONNECTOR.

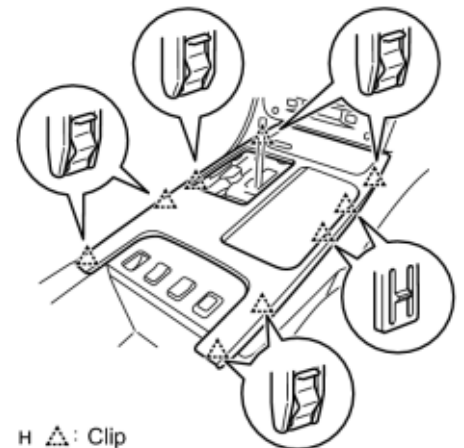

H Δ: Clip

**3. REMOVE PASSENGER SIDE INSTRUMENT PANEL FINISH PANEL END**

- A. REMOVE THE SCREW.
- B. USING A SCREWDRIVER, DETACH THE 3 CLIPS AND 3 CLAWS.
- C. REMOVE THE FINISH PANEL END.

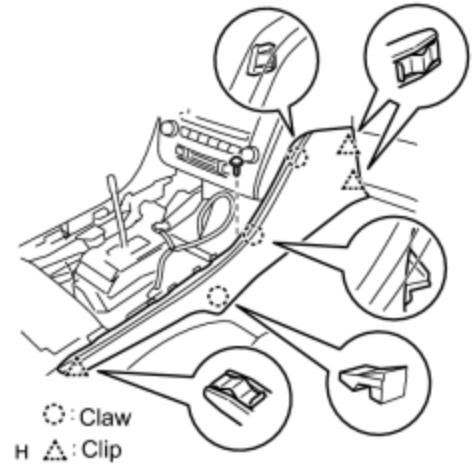
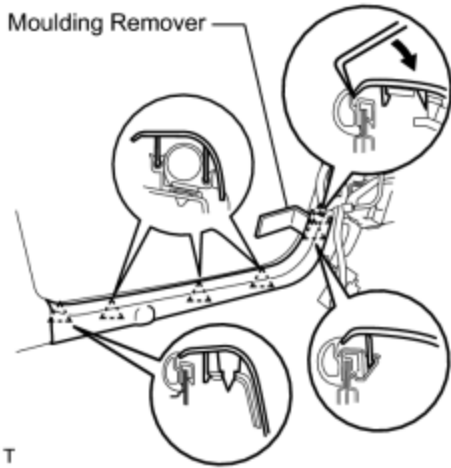

**4. REMOVE PASSENGER SIDE FRONT DOOR SCUFF PLATE**

- A. USING A MOLDING REMOVER, DETACH THE 5 CLAWS AND REMOVE THE SCUFF PLATE.

**5. REMOVE PASSENGER SIDE FRONT DOOR OPENING TRIM COVER**

- A. USING A MOLDING REMOVER, DETACH THE 3 CLAWS AND REMOVE THE TRIM COVER.

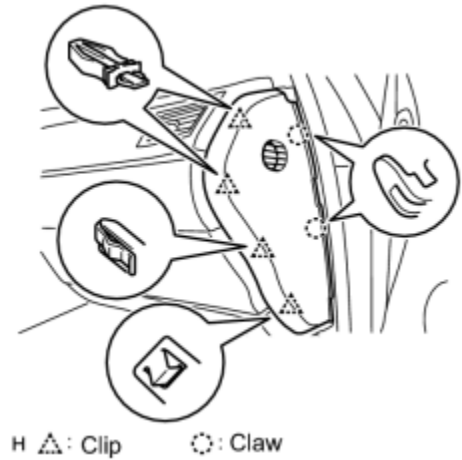

**6. REMOVE PASSENGER SIDE INSTRUMENT SIDE PANEL**

- A. USING A SCREWDRIVER, DETACH THE 2 CLAWS AND 4 CLIPS, AND REMOVE THE SIDE PANEL.

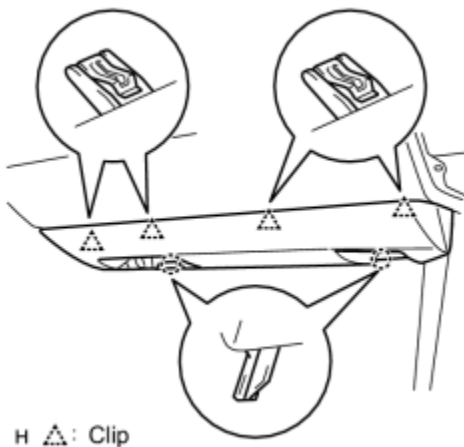

**7. REMOVE NO.2 INSTRUMENT PANEL UNDER COVER SUB-ASSEMBLY**

- A. USING A SCREWDRIVER, DETACH THE 4 CLIPS
- B. DISCONNECT THE CONNECTOR AND CLAMP, AND REMOVE THE UNDERCOVER.

**8. REMOVE FRONT PASSENGER SIDE KNEE AIRBAG ASSEMBLY**

- A. REMOVE THE 3 BOLTS AND FRONT PASSENGER SIDE KNEE AIRBAG ASSEMBLY
- B. DISCONNECT THE CONNECTOR
  - I. WHEN HANDLING THE AIRBAG CONNECTOR, TAKE CARE NOT TO DAMAGE THE AIRBAG WIRE HARNESS.

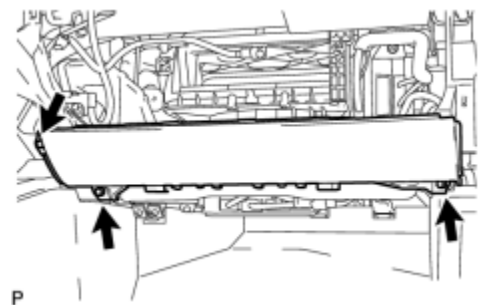



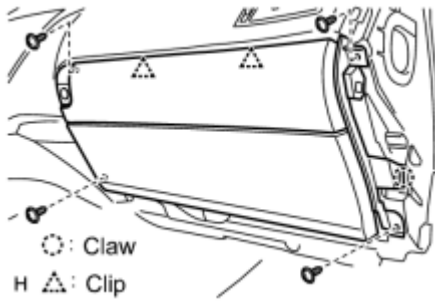

**9. REMOVE GLOVE COMPARTMENT DOOR SUB-ASSEMBLY**

- A. REMOVE THE 4 SCREWS.
- B. DETACH THE 2 CLIPS AND CLAW.
- C. DISCONNECT THE CONNECTOR AND CLAMP.
- D. REMOVE THE GLOVE COMPARTMENT DOOR.

**10. PRESS THE "PUSH" BUTTON AND SLIDE IT TO THE LEFT. THIS WILL OPEN THE DUST COVER AND EJECT THE DVD.**

**11. REMOVE AND DISCARD THE OLD DVD, OR IF ELIGIBLE RETURN FOR REBATE.**

**12. INSERT THE NEW NAVIGATION DVD.**

**13. NAVIGATION SYSTEM SHOULD NOW UPDATE AUTOMATICALLY.**

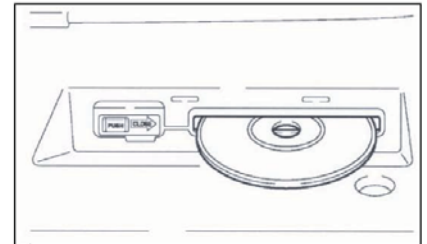

# ES 300

1. REMOVE NAVIGATION ECU COVER
  - A. DISENGAGE THE 2 CLIPS AND 2 CLAWS, AND THEN REMOVE THE NAVIGATION ECU COVER.
2. PRESS THE "PUSH" BUTTON AND SLIDE IT TO THE LEFT. THIS WILL OPEN THE DUST COVER AND EJECT THE DVD.
3. REMOVE AND DISCARD THE OLD DVD, OR IF ELIGIBLE RETURN FOR REBATE.
4. INSERT THE NEW NAVIGATION DVD.
5. NAVIGATION SYSTEM SHOULD NOW UPDATE AUTOMATICALLY.

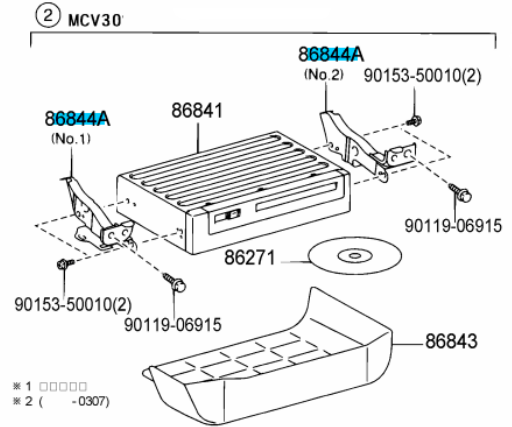
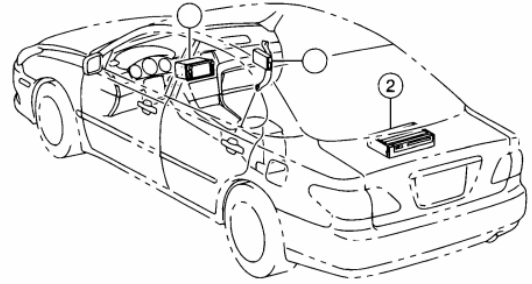

# RX 300

Engine Room J/B  
● DOME Fuse

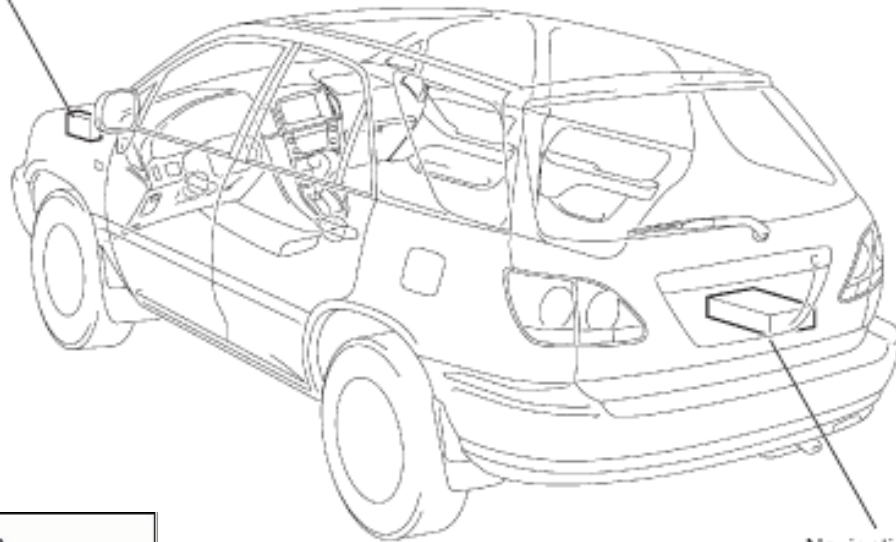

Navigation ECU

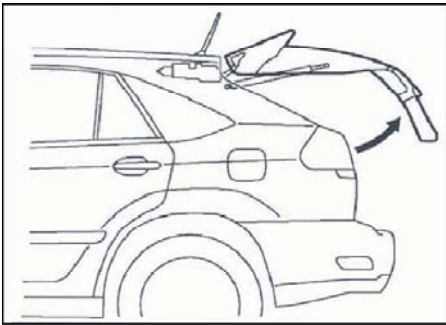

1. TURN THE IGNITION SWITCH TO THE "ACC" OR "ON" POSITION.
2. OPEN THE REAR HATCH.

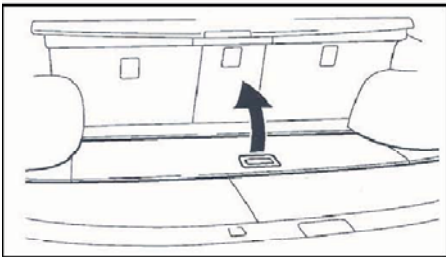

3. OPEN THE DECK BOARD SUB-ASSEMBLY.
4. SUPPORT THE DECK BOARD VIA THE SUPPORTING ROD.

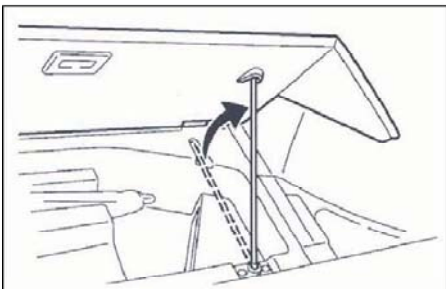

5. DISENGAGE THE 2 CLAWS.
6. REMOVE THE NAVIGATION ECU COVER.
7. PRESS THE "PUSH" BUTTON AND SLIDE IT TO THE LEFT. THIS WILL OPEN THE DUST COVER AND EJECT THE DVD.
8. REMOVE AND DISCARD THE OLD DVD, OR IF ELIGIBLE, RETURN FOR REBATE.

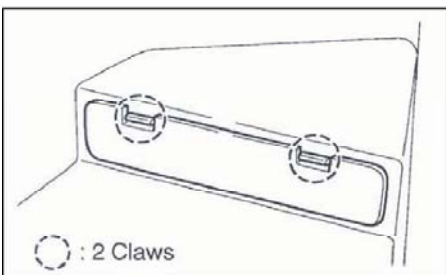

9. INSERT NEW NAVIGATION DVD.
10. NAVIGATION DISC SHOULD UPDATE AUTOMATICALLY.

# IS 300

**Sedan:**

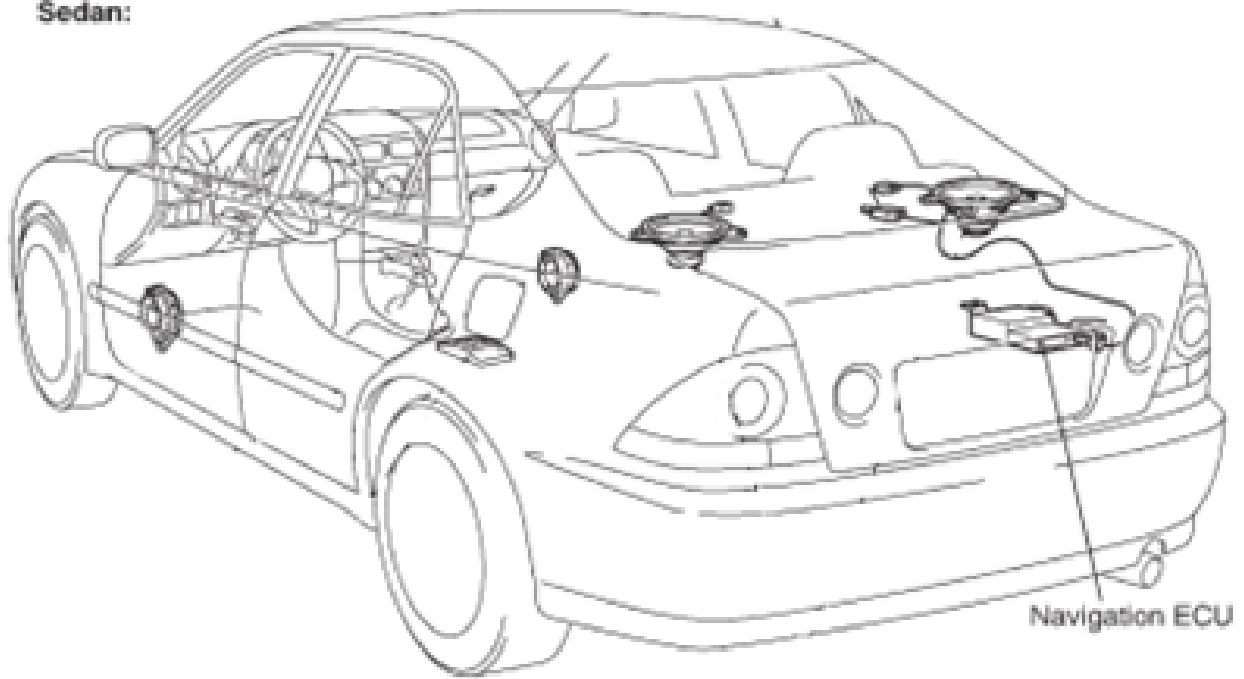

# GX 470

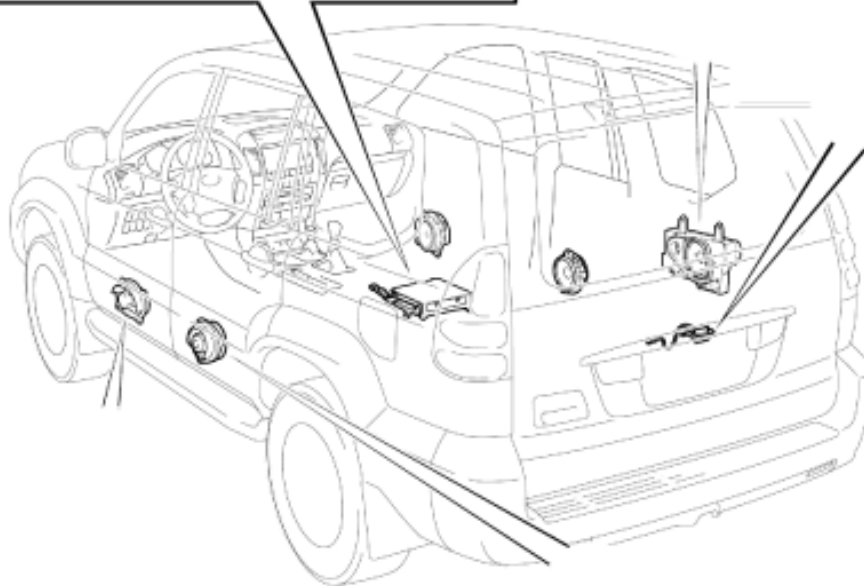
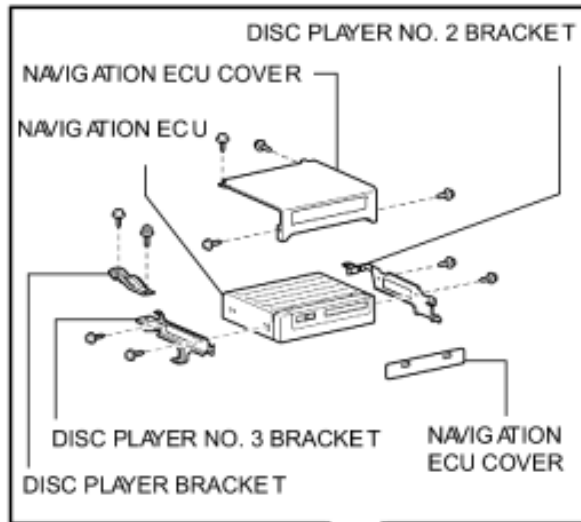

## 1. REMOVE THE NAVIGATION ECU COVER

- I. MOVE THE FRONT PASSENGER SEAT TO ITS MOST FORWARD POSITION
- II. RELEASE THE 2 CLAWS TO REMOVE THE ECU COVER.

## 2. REPLACE THE NAVIGATION DVD.

- I. TURN THE IGNITION SWITCH TO THE "ACC" OR "ON" POSITION.
- II. PRESS THE "PUSH" BUTTON AND SLIDE IT TO THE LEFT. THIS WILL OPEN THE DUST COVER AND EJECT THE DVD.
- III. REMOVE AND DISCARD THE OLD DVD, OR IF ELIGIBLE, RETURN FOR REBATE.
- IV. INSERT THE NEW NAVIGATION DVD.
- V. PRESS THE "PUSH" BUTTON AND SLIDE IT TO THE RIGHT. THIS WILL CLOSE THE DUST COVER.
- VI. NAVIGATION DISC SHOULD UPDATE AUTOMATICALLY.

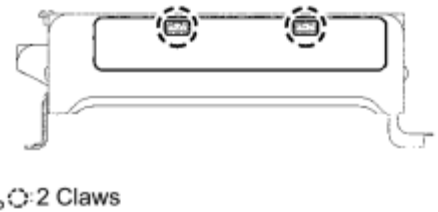

## 3. REINSTALL THE NAVIGATION ECU COVER IN THE SAME MANNER IT WAS REMOVED.

# IS 250/350

## 1. EJECT MAP DISC

- A. TURN THE IGNITION SWITCH TO THE “ACC” OR “ON” POSITION.
- B. APPLY PROTECTIVE TAPE TO THE PLACES SHOWN IN THE ILLUSTRATION.

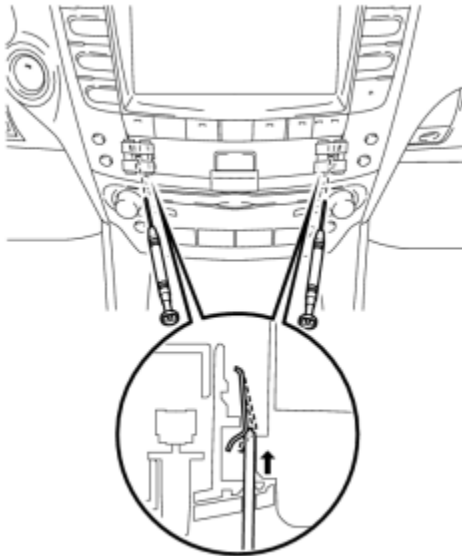

- C. INSERT 2 PRECISION SCREWDRIVERS ( $\phi$  1.5 OR LESS) INTO THE HOLES ON BOTH SIDES OF THE CLOCK ASSEMBLY AT THE ANGLE SHOWN IN THE ILLUSTRATION.

- I. NOTICE: DO NOT PRY THE CLOCK ASSEMBLY WITH THE SCREWDRIVERS AS IT MAY DAMAGE THE CLOCK ASSEMBLY.

P

- D. INSERT A PROTECTIVE TAPED SCREWDRIVER FROM THE UNDERSIDE OF THE HAZARD SWITCH AND PULL AND REMOVE THE CLOCK ASSEMBLY.
  - I. NOTICE: DO NOT PRY ON THE HAZARD SWITCH WITH THE SCREWDRIVER AS IT MAY DAMAGE THE SWITCH.

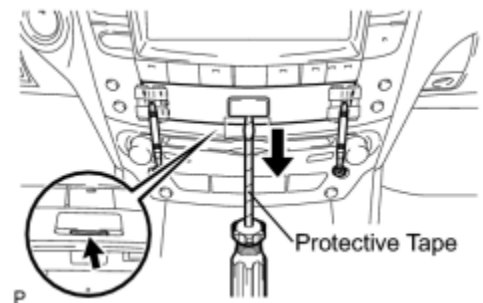

- E. REMOVE THE 2 PRECISION SCREWDRIVERS.
- F. PUSH THE “MENU” BUTTON.
- G. TOUCH “MAP DVD” ON THE NAVIGATION SCREEN.
- H. TOUCH “EJECT DVD” ON THE NAVIGATION SCREEN TO EJECT THE MAP DISC.
  - I. REMOVE AND DISCARD THE OLD DVD, OR IF ELIGIBLE, RETURN FOR REBATE.

## 2. REPLACE THE NAVIGATION DISC

- A. INSERT THE NEW NAVIGATION DVD.
- B. NAVIGATION DISC SHOULD UPDATE AUTOMATICALLY.

# RX 350

## 1. EJECT MAP DISC

- A. DISENGAGE THE 2 CLIPS AND 2 GUIDES, AND REMOVE THE FRONT CONSOLE BOX COVER.
- B. TURN THE IGNITION SWITCH TO THE “ACC” OR “ON” POSITION.
- C. PUSH THE “MENU” BUTTON ON THE REMOTE OPERATION CONTROLLER.
- D. OPERATE THE REMOTE OPERATION CONTROLLER AND SELECT “INFO. PHONE” ON THE NAVIGATION SCREEN.
- E. OPERATING THE REMOTE OPERATION CONTROLLER, SELECT “MAP DATA” ON THE NAVIGATION SCREEN.
- F. OPERATING THE REMOTE OPERATION CONTROLLER, SELECT “EJECT DVD” ON THE NAVIGATION SCREEN TO EJECT THE MAP DISC FROM THE NAVIGATION RECEIVER.
- D. REMOVE AND DISCARD THE OLD DVD, OR IF ELIGIBLE, RETURN FOR REBATE.

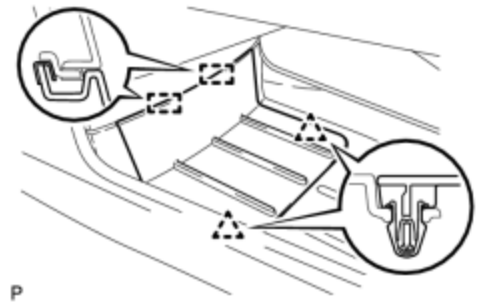

## 3. REPLACE THE NAVIGATION DISC

- A. INSERT THE NEW NAVIGATION DVD.
- B. NAVIGATION DISC SHOULD UPDATE AUTOMATICALLY.

# ES 350

## 1. EJECT MAP DISC

- A. DISENGAGE THE 8 CLAWS AND REMOVE THE COVER AS SHOWN IN THE ILLUSTRATION.

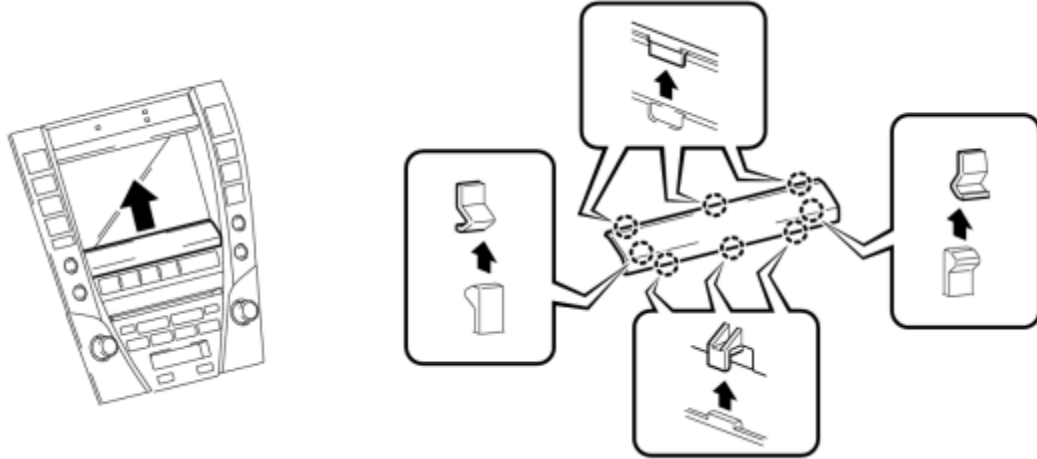

P

- B. TURN THE IGNITION SWITCH TO THE “ACC” OR “ON” POSITION
- C. PUSH THE “MENU” BUTTON.
- D. TOUCH “MAP DVD” ON THE NAVIGATION SCREEN.
- E. TOUCH “EJECT DVD” ON THE NAVIGATION SCREEN TO EJECT THE MAP DISC.
- F. REMOVE AND DISCARD THE OLD DVD, OR IF ELIGIBLE, RETURN FOR REBATE.

## 2. REPLACE THE NAVIGATION DISC

- A. INSERT THE NEW NAVIGATION DVD.
- B. NAVIGATION DISC SHOULD UPDATE AUTOMATICALLY.