

**Part Number: PT278-48140**

**Kit Contents**

Item #	Quantity Reqd.	Description
1	1	Crossbar Assembly Front
2	1	Crossbar Assembly Rear
3	2	RH Crossbar Covers
4	2	LH Crossbar Covers
5	1	Hardware Bag

**Hardware Bag Contents**

Item #	Quantity Reqd.	Description
1	1	Torque Tool
2	4	Tethers
3	4	Anti-Rotation Caps
4	1	Users Guide
5		
6		
7		

**Additional Items Required For Installation**

Item #	Quantity Reqd.	Description
1		
2		
3		

**Conflicts**

--

**Recommended Tools**

<b>Personal &amp; Vehicle Protection</b>	<b>Notes</b>
Safety Glasses	
Safety Gloves	
Vehicle Protection	Cloth
Wrist & Belt Buckle Protection	
<b>Special Tools</b>	<b>Notes</b>
Plastic trim removal tool	
<b>Installation Tools</b>	<b>Notes</b>
13mm Socket	
Torque Wrench	0-75 Lbf-in
<b>Special Chemicals</b>	<b>Notes</b>

**General Applicability**

All models 2014-
------------------

**Recommended Sequence of Application**







Item #	Accessory
1	
2	
3	

\*Mandatory

**Vehicle Service Parts** (may be required for reassembly)

Item #	Quantity Reqd.	Description
1		
2		
3		

**Legend**

	<b>STOP:</b> Damage to the vehicle may occur. Do not proceed until process has been complied with.
	<b>OPERATOR SAFETY:</b> Use caution to avoid risk of injury.
	<b>CAUTION:</b> A process that must be carefully observed in order to reduce the risk of damage to the accessory/vehicle and to ensure a quality installation.
	<b>TOOLS &amp; EQUIPMENT:</b> Used in Figures calls out the specific tools and equipment recommended for this process.
	<b>REVISION MARK:</b> This mark highlights a change in installation with respect to previous issue.
	<b>SAFETY TORQUE:</b> This mark indicates that torque is related to safety.

**Procedure**

Care must be taken when installing this accessory to ensure damage does not occur to the vehicle. The installation of this accessory should follow approved guidelines to ensure a quality installation.

These guidelines can be found in the "Accessory Installation Practices" document.

This document covers such items as:-

- Vehicle Protection (use of covers and blankets, cleaning chemicals, etc.).
- Safety (eye protection, rechecking torque procedure, etc.).
- Vehicle Disassembly/Reassembly (panel removal, part storage, etc.).
- Electrical Component Disassembly/Reassembly (battery disconnection, connector removal, etc.).

Please see your Toyota dealer for a copy of this document.

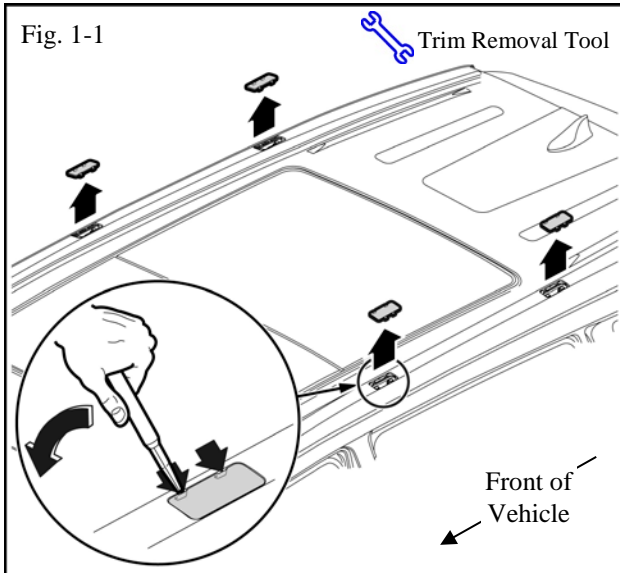

**1. Remove side rail covers (Fig. 1-1).**

- ⚠ (a) Using a plastic trim removal tool, carefully remove the 4 trim covers by pressing the tabs and prying up (4 places).
- ⚠ (b) Place the covers in the glove box.

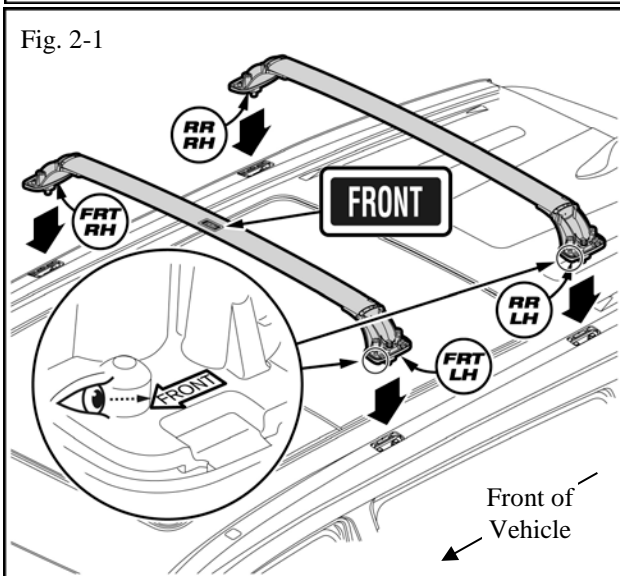

**2. Install crossbars (Fig. 2-1).**

- ⚠ (a) Make sure the arrows on the crossbar end supports are pointing toward the front of the vehicle.
- ⚠ **NOTE: FRONT CROSSBAR HAS "FRONT" LABEL.**
- ⚠ **NOTE: FRONT AND REAR, LH AND RH, ARE MOLDED INTO THE SUPPORT PAD BOTTOM.**

Procedure

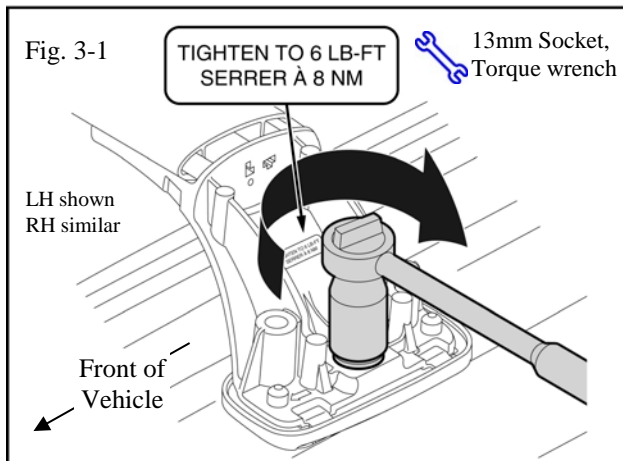

3. Secure crossbars (Fig. 3-1).

- ⚠ (a) Using a 13mm socket, tighten the bolt to 8 N·m (71 Lbf-in) (4 places).

**Torque: 8 N·m (71 in·lbs)**

- ⚠ (b) Verify all supports are snug and properly fitted to the side rail (4 places).

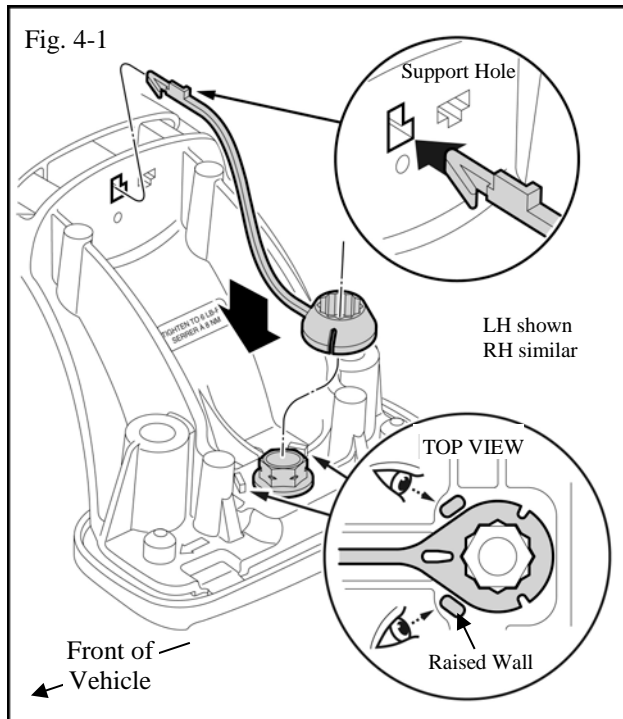

4. Attach anti-rotation caps to crossbars (4 Places) (Fig. 4-1).

- (a) Install the tether end of the anti-rotation cap into the crossbar support.
- (b) Install a cap over the crossbar bolt.

⚠ **NOTE: Verify the proper orientation of the tether into the hole specified in Fig. 4-1.**

⚠ **NOTE: Verify the tether is fully engaged and locked into the support.**

⚠ **NOTE: Verify the caps are fully engaged over the bolt.**

⚠ **NOTE: Verify the caps are centered between the 2 small raised walls on the support.**

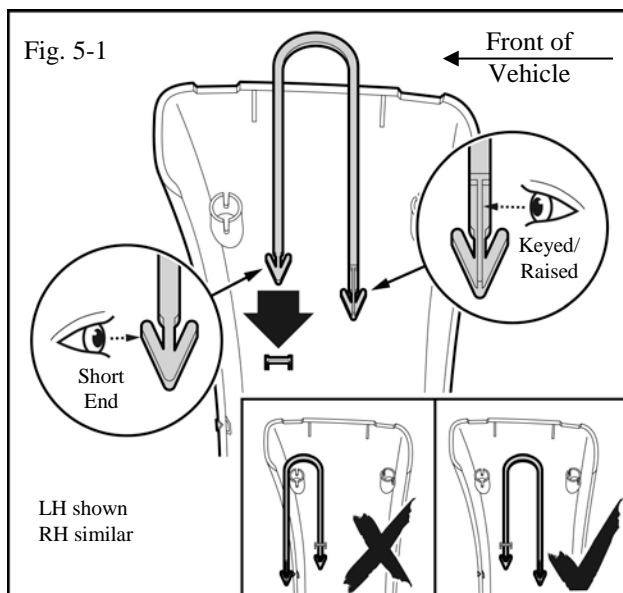

5. Attach tethers to crossbar covers.

- (a) Install the 4 tethers on the covers (2 RH, 2 LH) (Fig. 5-1).

- (1) Install the short end of the tether through the loop on the cover.

⚠ **NOTE: Verify the tether is centered in the cover.**

⚠ **NOTE: Verify the tether is fully engaged and locked into the cover.**

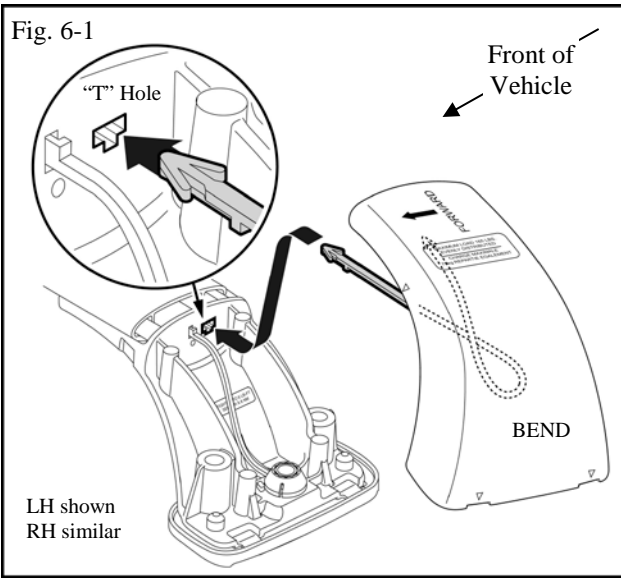

**6. Attach tethers to crossbars (Fig. 6-1).**

- (a) Install the 4 tethers (2 RH, 2 LH) with covers on to the crossbar supports.

- (1) The tether is flat and must be bent when installing (Fig. 6-1).

**⚠ NOTE: Verify the proper orientation of the keyed/raised end of the tether when inserting into the “T” shape hole in the crossbar support (Fig. 6-1).**

**⚠ NOTE: Verify the tether is fully engaged and locked into the support.**

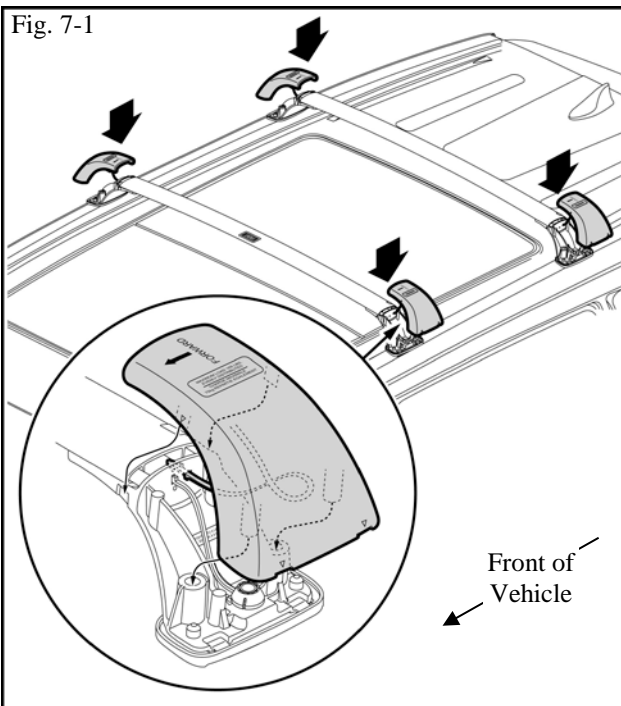

**7. Install crossbar covers.**

- (a) Install the crossbar covers (4 places) (Fig. 7-1).

- (1) Line up the cover posts with the holes in the supports. Press down firmly (Fig. 7-1).

**⚠ NOTE: Make sure the covers are fully engaged at each location marked with a triangle (16 places) (Fig. 7-2).**

**8. Install Installation Instructions.**

- STOP** (a) Place the crossbar Users Guide and torque tool in the vehicle’s glove box.

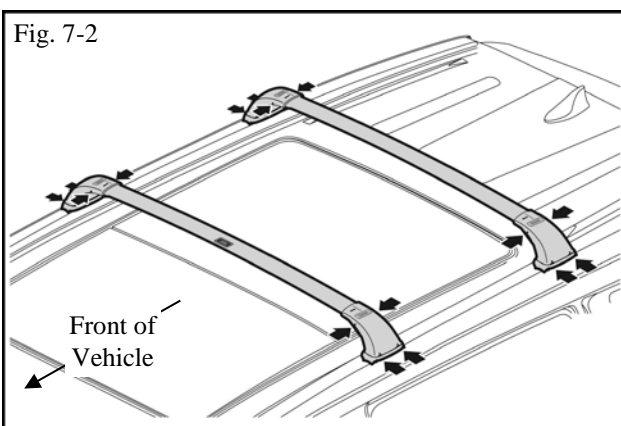

**TOYOTA Highlander/HV w/Side Rail 2014 -**

**CROSSBAR KIT**

Checklist - these points **MUST** be checked to ensure a quality installation.

<u>Check:</u>	<u>Look For:</u>
<p><u>Accessory Function Checks</u></p> <ul style="list-style-type: none"><li><input type="checkbox"/> Inspect bolt torque</li><li><input type="checkbox"/> Ensure crossbars are secure and in correct position</li><li><input type="checkbox"/> Crossbar Users Guide/Torque Tool</li> <li><input type="checkbox"/> Crossbar cover engagement</li></ul>	<p>Crossbar support bolt: <b>8 N•m (71 in•lbs)</b></p> <p>Front crossbar has “FRONT” label.</p> <p>Users Guide and torque tool inside vehicle glove box.</p> <p>Ensure crossbar covers are fully engaged.</p>
<p><u>Vehicle Function Checks</u></p> <ul style="list-style-type: none"><li><input type="checkbox"/></li></ul>	
<p><u>Vehicle Appearance Check</u></p> <ul style="list-style-type: none"><li><input type="checkbox"/> After accessory installation, perform a visual inspection.</li></ul>	<p>Ensure no damage (including scuffs and scratches) was caused during the installation process.</p> <p>(For PPO installations, refer to TMS Accessory Quality Shipping Standard.)</p>



Showing results for "PT278-48140"

Show results for

Automotive >

Cargo Racks

+ See All 2 Departments

Refine by

Avg. Customer Review

★★★★☆ & Up

★★★★☆ & Up

★★★★☆ & Up

★★★★☆ & Up

Condition

New

Used



### Genuine Toyota (PT278-48140) Roof Rail Cross Bar Nov 1, 2014

by Toyota

**\$259.99**

More Buying Choices

**\$239.30** new (16 offers)

★★★★☆ 21

FREE Shipping

**Product Features**

Genuine Toyota Accessories PT278-48140 Highlander Roof Rails Cross Bars

**Automotive:** [See all items](#)

**Sponsored Links** [\(What's this?\)](#)

- 1. [Part# Pt278-48140](#) Save Big on OEM Toyota Parts when You Shop Vandergriff Toyota Parts! [parts.vandergrifftoyota.com/](http://parts.vandergrifftoyota.com/)
- 2. [PT27848140: Order Online](#) Xbar hglnr w gns. Choose Genuine Parts: \$244.00 [toyotascionpartsstore.com/Pt27848140](http://toyotascionpartsstore.com/Pt27848140)
- 3. [GenuineToyota Roof Racks](#) Toyota Highlander Cross Bars Rails **PT278-48150** Summertime Fun Ship Now [parts.toyotaofnashua.com/](http://parts.toyotaofnashua.com/)

#### Search Feedback

Did you find what you were looking for?

If you need help or have a question for Customer Service, please [visit the Help Section](#).

[Ad feedback](#)

Search powered by

[Ad feedback](#)

## Your Recently Viewed Items and Featured Recommendations

### Get to Know Us

- [Careers](#)
- [Investor Relations](#)
- [Press Releases](#)
- [Amazon and Our Planet](#)
- [Amazon in the Community](#)
- [Amazon Devices](#)

### Make Money with Us

- [Sell on Amazon](#)
- [Sell Your Services on Amazon](#)
- [Sell Your Apps on Amazon](#)
- [Become an Affiliate](#)
- [Advertise Your Products](#)
- [Self-Publish with Us](#)
- [Become an Amazon Vendor](#)
- [› See all](#)

### Amazon Payment Products

- [Amazon.com Rewards Visa Card](#)
- [Amazon.com Store Card](#)
- [Amazon.com Corporate Credit Line](#)
- [Shop with Points](#)
- [Credit Card Marketplace](#)
- [Amazon Currency Converter](#)

### Let Us Help You

- [Your Account](#)
- [Shipping Rates & Policies](#)
- [Amazon Prime](#)
- [Returns & Replacements](#)
- [Manage Your Content and Devices](#)
- [Help](#)



[Australia](#) [Brazil](#) [Canada](#) [China](#) [France](#) [Germany](#) [India](#) [Italy](#) [Japan](#) [Mexico](#) [Netherlands](#) [Spain](#) [United Kingdom](#)

**6pm**  
Score deals on fashion brands

**AbeBooks**  
Rare Books & Textbooks

**ACX**  
Audiobook Publishing Made Easy

**AfterSchool.com**  
Kids' Sports, Outdoor & Dance Gear

**Alexa**  
Actionable Analytics for the Web

**Amazon Business**  
Everything For Your Business

**AmazonFresh**  
Groceries & More Right To Your Door

**Amazon Local**  
Great Local Deals in Your City

**Amazon Home Services**  
Handpicked Pros Happiness Guarantee

**Amazon Web Services**  
Scalable Cloud Computing Services

**Audible**  
Download Audio Books

**BeautyBar.com**  
Prestige Beauty Delivered

**Book Depository**  
Books With Free Delivery Worldwide

**Casa.com**  
Kitchen, Storage & Everything Home

**ComiXology**  
Thousands of Digital Comics

**CreateSpace**  
Indie Print Publishing Made Easy

**Diapers.com**  
Everything But The Baby

**DPReview**  
Digital Photography

**East Dane**  
Designer Men's Fashion

**Fabric**  
Sewing, Quilting & Knitting

**Goodreads**  
Book reviews & recommendations

**IMDb**  
Movies, TV & Celebrities

**Junglee.com**  
Shop Online in India

**Kindle Direct Publishing**  
Indie Digital Publishing Made Easy

**Look.com**  
Kids' Clothing & Shoes

**MYHABIT**  
Private Fashion Designer Sales

**Shopbop**  
Designer Fashion Brands

**Soap.com**  
Health, Beauty & Home Essentials

**TenMarks.com**  
Math Activities for Kids & Schools

**VineMarket.com**  
Everything to Live Life Green

**Wag.com**  
Everything For Your Pet

**Warehouse Deals**  
Open-Box Discounts

**Woot!**  
Discounts and Shenanigans

**Yoyo.com**  
A Happy Place To Shop For Toys

**Zappos**  
Shoes & Clothing

[Conditions of Use](#) [Privacy Notice](#) [Interest-Based Ads](#) © 1996-2015, Amazon.com, Inc. or its affiliates