

Harrop Performance Differentials



Harrop / Eaton ELocker™ Differential Generic Operating & Intallation Instructions

ELocker Differential Operating & Installation Instructions

Congratulations! You have just purchased the latest innovation in locking differential technology – the Harrop/Eaton ELocker differential.

The following information has been designed to help you become familiar with how your ELocker differential works, how it should be installed, and how it should be used.

How does the ELocker differential work?

The ELocker differential is a driver-controlled, electronically activated locking differential that can easily replace a traditional differential to gain much more traction and off-road capability. During everyday use or on-road driving, the ELocker differential operates as an “open” differential. This enables easy manoeuvrability in tight parking lots and good road manners while cornering. However, when the terrain gets tough, or ultimate traction is needed, a switch allows the driver to fully lock the differential. A locked differential provides 100% of the drive torque to both wheels at any given moment, enabling difficult obstacles to be easily overcome. ELocker differentials can be used on the front, as well as the rear axle for off-road capabilities, providing performance unsurpassed by other traction modifying devices.

The ELocker differential is a new age Original Equipment electro-mechanical product from Eaton Corporation (USA) which has been re engineered by Harrop (Australia) expanding the range to suit your model application. When the switch is activated, electric current is supplied to a powerful electromagnet. As the electromagnet is energized, a torque is created on a drag-plate that activates a ramping mechanism. The ramping mechanism, in turn, translates rotational force into the axial motion of a locking mechanism. The locking mechanism engages into slots or tabs on the differential side gear and locks the side gear rotation to the differential housing. The result is on-demand traction and a fully locked differential.

Once the obstacle is overcome and the ELocker differential is deactivated through the switch, a series of return springs promptly force the locking mechanism to disengage and the ELocker differential again operates as an “open” differential.

How do I use the ELocker differential?

The following information discusses proper operation of the ELocker differential:

Differential engagement should occur before an obstacle is encountered. If you feel that you are in a situation that may require extra traction, it is recommended to use the ELocker differential as an anticipatory device.

WARNING! - Only engage the ELocker differential while the vehicle is stationary or operating at speeds of 5 km/h or less with minimal wheel slippage. Engaging the ELocker while the wheel is spinning at a high rate or the vehicle is moving at more than 5 km/h may damage the differential's engagement pins or lock collar will be considered improper or abnormal use voiding the warranty. Harrop/Eaton will reject warranty claims if the returned ELocker has engagement pins or lock collars damaged by operation contrary to this warning.

Differential engagement should be deactivated after the difficult terrain is overcome. It is not recommended to deactivate the ELocker differential while the drivetrain has load or bind on it, such as under cornering. When the drivetrain is loaded, the ELocker differential may not immediately disengage, resulting in a locked differential when it is not desired.

Differential engagement should not be maintained at high speeds (greater than 30 km/h). A locked differential at higher speeds can cause undesirable vehicle behavior or loss of vehicle control. The ELocker differential may be deactivated via the switch while the vehicle is in motion.

When a front or rear differential is locked, the behavior and manoeuvrability of a vehicle is altered. Steering response and vehicle manoeuvrability may be reduced dramatically. Steering may be difficult with a front ELocker differential engaged. For this reason, a front ELocker differential should be used only at low vehicle speeds and only in 4WD mode.

Differential engagement should be used on low traction surfaces, such as those encountered in off-road use. Continuous operation of a locked differential on high traction surfaces produces unnecessary strain on drivetrain and chassis components while cornering in the vehicle. Caution should be taken when operating locked differentials on slippery terrain, such as icy surfaces. High speeds on slippery surfaces with a differential locked can result in undesirable vehicle behaviour or loss of vehicle control. Always operate the vehicle with care and reduced speed.

How do I maintain my ELocker differential?

The ELocker differential is built for robust performance and life. It is constructed of precision-forged gears, hardened lock collar, and a durable nodular cast iron housing. Installing a new differential is a fairly demanding job that requires close attention to tolerances and pre-loads, it is recommended that your ELocker be installed by a professional. Each vehicle is different, so it is necessary to follow all of the vehicle manufacturer's recommendations and installation requirements.

The following information details a few tech tips to ensure long life for your ELocker differential with proper installation and maintenance:

1. Side-bearing pre-load is extremely critical and must be set to the specifications of the vehicle's original equipment manufacturer.
2. Ring gear backlash is also performance critical and must be set to the specifications of the vehicle's original equipment manufacturer. Failure to properly set gear backlash can result in a poor ring and pinion contact pattern, and undesirable noise is likely.
3. If installing a new ring and pinion with your ELocker differential, proper break-in will help extend performance life. Avoid wide-open throttle starts for the first 80 kms. Avoid trailer towing for the first 800 kms. Once a gear set pattern has been established (typically within 160 kms) corrections will not be effective.
4. The axle lubricant recommended by the vehicle manufacturer for an open type differential should be used and changed periodically as per the vehicle manufacturer's recommendations. Always drain and dispose of used lubricant thoughtfully.
5. Dirt and water deteriorate any differential. Always replace the gaskets, check the seals and replace as necessary, use of a suitable sealant is recommended.

Installation Instructions

The following steps outline the procedure for installing an ELocker differential. It is recommended that you read the entire installation instructions prior to beginning the installation.

Please consult the vehicle service manual, in conjunction with these instructions, to properly disassemble and assemble all components.

Tools and Equipment:

Vehicle lift or hydraulic jack & jack-stands

Standard Metric socket and wrench set

Shop light

Torque wrench

Drill & Bits

Hole saw, 25.4mm

Oil drain pan

Gasket scraper

Magnetic base dial indicator

Centre punch

Hammer, ball pein & soft type

Bearing puller

Bearing driver

Shop wiper cloths

Loctite 262

Replacement side carrier bearings, if required

Gasket sealant

Differential & axle gaskets

Differential oil

Brake fluid, if required



ELocker kit contents (See Figure A)

- 1 x ELocker differential carrier assembly
- 1 x Wire harness, front, with relay & switch
- 1 x Wire harness, under vehicle
- 1 x Conduit, wire harness
- 1 x Connector housing, electromagnet
- 1 x Cable ties packet
- 1 x Operation and Installation Instructions
- 1 x Harrop Sticker

Upon checking the kit contents record the ELocker warranty details as listed at the end of this document

Step 1 – Begin to Install Wiring (See Figure B)

With the provided wiring kit, begin to lay out the wiring for the installation. Temporarily position wiring in its intended location along the frame from the axle housing to the power source. Later in the process, the protective plastic conduit (included) can be installed where needed and the harness can be securely fastened in place. Position the harness so it is sheltered from the likes of hot exhaust parts, sharp edges moving parts or areas vulnerable to stick or rock damage. The harness should enter the vehicle cabin in a convenient location.

Step 2 – Install Instrument Panel Switch

Locate a point on the instrument panel where the switch can be mounted conveniently, ensure a back clearance of 55mm is available for the switch. Carefully cut a 25.4mm (1") diameter hole in the selected location for the switch installation. Before inserting the switch in the opening, securely connect the wires to the pins on the back of the switch as per the wiring diagram. Be sure that the terminals are firmly in place. Tie up any excess wire and fix it behind the instrument panel. Press the switch into the opening until it is secured.

Note: For both safety and ease of operation the switch location should be located to best suit the vehicle driver. The following points must be considered:

- The switch/s must be securely mounted to the vehicle.
- The switch/s should be within easy reach of the driver in the normal driving position.
- The switch/s should be mounted within the line sight of the driver to enable visual observation of the switch on/off positions.
- The switch/s position should be such that accidental operation by the driver or passenger is not possible.

Step 3 – Mount Relay

Locate a region behind the instrument panel to mount the relay. Secure the relay in place.

Step 4 – Connect to Power Supply

Connect the RED wire (with the eye loop) to a constant 12V power supply, such as the positive terminal on the battery or a live terminal at the junction box. Connect the BLUE wire (with the eye loop) to a power supply from the ignition of the vehicle. This power supply should only be active when the vehicle is running or the ignition is turned "on." Connect the BLACK wire (with the eye loop) to a grounded point on the vehicle, such as the negative terminal of the battery or a bare metal stud.

Step 5 – Raise Vehicle

The rear axle (or front) wheels must be raised from the ground and the vehicle secured in a safe manner. The use of a vehicle hoist is preferable, however the installation can be accomplished at floor level. Be certain the vehicle is secured safely on jack stands and the transmission is in the neutral position.

Step 6 – Remove Wheels

Remove the rear wheels and set them aside.

Step 7- Drain Gear Lube

Position a drain pan under the differential. Remove the drain plug and allow the oil to fully drain. Dispose of waste oil thoughtfully.

Step 8 – Disassemble Brakes (if applicable)

Refer to the manufacturers repair manual.

Figure A



Figure B

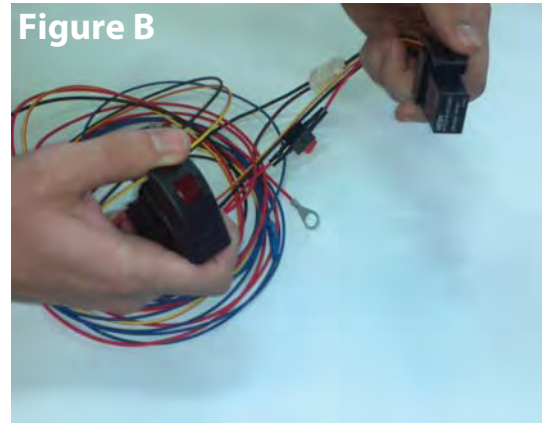

Figure C

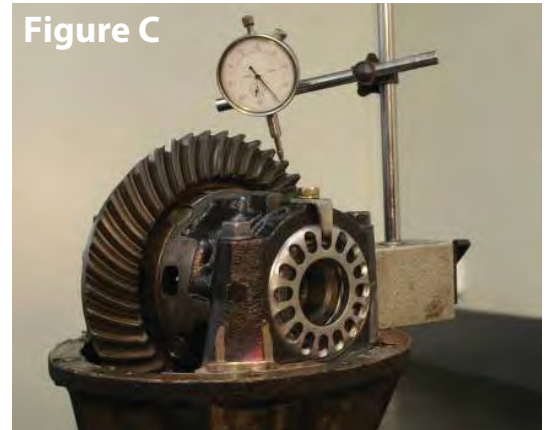
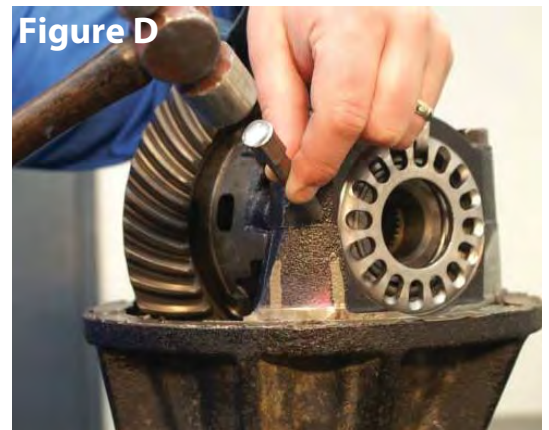

Figure D



Step 9 – Remove Axle Shafts

Refer to the manufacturers repair manual.

Step 10 – Remove the differential carrier assembly

Refer to the Manufacturers repair manual

Step 11 – Measure Backlash

If the same ring gear and pinion set will be used, it is necessary to measure the current gear backlash (movement between the drive pinion and differential ring gear, typically $0.2 \pm 0.05\text{mm}$ (refer to the manufacturers repair manual for specifications). Securely mount the differential carrier in a bench vice. Secure a magnetic base dial indicator on the flat surface of the differential carrier. Measure the backlash by measuring the free movement of the ring gear back and forth between the stationary drive pinion gear teeth. Record the measurement for later use. Rotate the ring gear 180 deg and repeat the backlash measurement. (If you are replacing the ring and pinion gear set at this time, refer to the vehicle service manual for applicable procedures).

Step 12- Mark the bearing caps

Using a centre punch, place matchmarks on both bearing caps and the adjoining surface on the differential carrier to aid correct re assembly.

Step 13 – Remove the differential carrier

Remove the side bearing adjuster lock tabs. Remove the bearing caps and adjusting nuts. Carefully remove the carrier from the housing. Tag the bearing cups for position identification if they are to be re used. Inspect the bearings for serviceability, remove if required using a suitable bearing puller.

Note: on some early Toyota variants originally fitted with 45mm ID bearings will require an upgrade to the larger 50mm ID bearings, part number: 32010X/QCL7CVB026 (RB) Models with existing 50mm ID bearings are as per the original fitment.

Step 14 – Remove Ring Gear (See Figure E)

Remove the ring gear bolts by loosening bolts in a diagonal pattern, discard the lock plates if fitted. The ring gear is an interference fit on the carrier requiring removal using a soft hammer or suitable drift.

Step 15 – Install Ring Gear (See Figure F)

Wipe clean the surfaces on the differential housing flange and pilot. Also, be certain all mating surfaces on the ring gear are clean and free of debris and burrs.

Heat the ring gear in hot water or an oven to 90 deg C. Air dry, then quickly and with care, place the ring over the anti rotation tab with the wire harness attached, then pass the ring gear over the tab on the opposite side. Fully install the ring gear while aligning the through holes of the flange with the threaded holes on the ring gear.

Apply Loctite to the ring gear bolts. Tighten the ring gear bolts in a diagonal pattern. Continue this pattern until all ring gear bolts are tightened to manufacturer's specifications, typically 100 - 120 N-m (75 - 90 ft-lb).

Note 1: Do not use a naked flame to heat the ring gear as softening of the metal can occur.

Note 2: Extra care is required when passing the ring gear over the electromagnet wiring during installation to avoid possible wiring damage.

Hint: To assist with the ring gear installation, use a surplus ring gear bolt with the head removed for use as alignment spigot.

Step 16 – Install Bearings (See Figure G)

Wipe clean the bearing hub surfaces with a shop wiper cloth. Using an arbor press or similar and a bearing driver, carefully press the bearing cones onto the bearing hubs up to the hub shoulder. Ensure the bearings are fully seated against the bearing hub shoulder.

Step 17 – Preparing to install ELocker differential

Using a gasket scraper, remove all remaining gasket material from the differential carrier and the axle housing. Carefully clean both inside and outside of the differential carrier.

Step 18 – Drill Grommet Hole (See Figure H)

An exit hole for the ELocker coil wire grommet will need to be drilled in the top side of the differential housing. Place the ELocker into the axle housing with the anti rotation tabs oriented between the bearing cap end faces (the tab positions must allow for some free movement of the electromagnet), taking careful note of wire location. As an aid, temporarily fit the side bearing adjuster nuts and position the ELocker so it has minimal backlash. The hole location should be in an area that will keep the wiring away from rotating parts and sharp edges. Once the ideal grommet location has been determined, based on wire length and carrier configuration, mark the housing and remove the carrier.

Figure E



Figure F

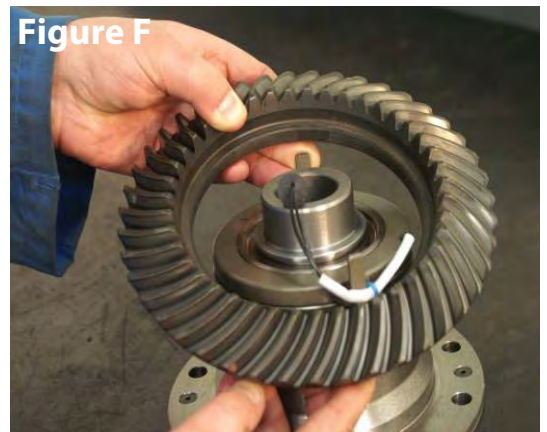

Figure G



Figure H



Tightly pack wiper cloths around the pinion and oil passages to minimise any swarf ingress. Remove the housing from the vice and place on the bench with the pinion facing up. Mark the housing at the selected location on the outside using a centre punch and drill a 11.5mm (29/64") diameter thru hole. Remove any burrs and thoroughly clean the housing ready for final assembly.

Note 1: On Toyota Land Cruiser 80 & 100 with RFS the front differential is inverted i.e.; the pinion is above the axle centreline. Caution is required to ensure the hole is not drilled on the underside.

Note 2: Precautionary use of a suitable protector (wood or aluminium block) is required during drilling to ensure the drill does not come into contact with the pinion.

Step 19 – Assemble the ELocker Housing (See Figure I)

Place the ELocker and bearing cups into the carrier, align the anti rotation tabs with the bearing cap. Route the electro magnet wire leads to exit the newly drilled hole, at this stage do not install the grommet. Fit the side bearing adjusting nuts ensuring they are correctly seated in the carrier threads. Align the bearing caps with the previous matchmarks and screw in the bolts a few turns. Push the caps into place noting their correct engagement with the adjusting nuts. Check the harness to ensure it has not been pinched during assembly. Run the bolts down and lightly nip them up.

Note: In some instances the electromagnet tabs may require temporarily bending outwards slightly to enable the bearing cap to pass through.

Step 20 – Measure Backlash (See Figure I)

Adjust the side bearing preload by tightening the adjusting nuts accordingly, always ensure some backlash is evident to avoid the gears from binding, refer to the Manufacturers repair manual for the procedure. Use the previous procedure to re check the backlash, adjust as necessary. If a new ring and pinion gear set is to be installed, adjust backlash to be within the Manufacturers repair manual specification.

Note 1: Incorrect side bearing preload can lead to premature bearing failure, undue noise and possible ring & pinion failure.

Note 2: Incorrect backlash can cause undue noise.

Note 3: Any doubt between the backlash data recorded prior to disassembly and the Manufacturers data, must be confirmed using the tooth contact marking process outlined in the Manufacturers repair manual.

Step 21 – Complete the Bearing Cap Installation (See Figure K & L)

Torque down the bearing cap bolts and fit the bearing adjuster locks, refer to the Manufacturers repair manual for torque specifications. Reconfirm the electromagnet anti rotation tabs allow radial free play of approx 2mm, adjust as required by bending the tabs inwards if the E-locker has been supplied with an anti rotation tab bracket, fit as shown in Figure O. Once it has been determined that the differential has been satisfactorily assembled, fully seat the harness grommet through the newly drilled hole. The harness length can be adjusted through the grommet to avoid contact with rotating parts whilst ensuring it is not pulled tight with the electromagnet freeplay.

Step 22 – Reinstall the Differential to the Vehicle

Apply suitable sealant to a new differential gasket. Install the differential to the housing. Tighten the fixings in a diagonally opposite pattern. Install the propeller shaft.

Step 23 – Reinstall the Axles to the Vehicle

Replace the axle gaskets and seals. Install the axle shafts, refer to the manufacturers repair manual, taking care not to damage the seals.

Step 24 – Re install the Brakes (if applicable)

Refer to the manufacturers repair manual.

Step 25 – Re install the Wheels

Re install the wheels taking care to tighten the lug nuts in a diagonal procedure to the proper torque specification.

Step 26 – Fill differential with Lubricant

Ensure the vehicle is in a level position. Remove filler plug and refill with the recommended volume and type of differential lubricant. Rotate the propeller shaft a few times and recheck the fluid level. Re install and tighten the filler plug.

The ELocker is designed to operate with those lubricants recommended by the vehicle manufacturer for conventional differentials eg SAE 80/90, API, GL5

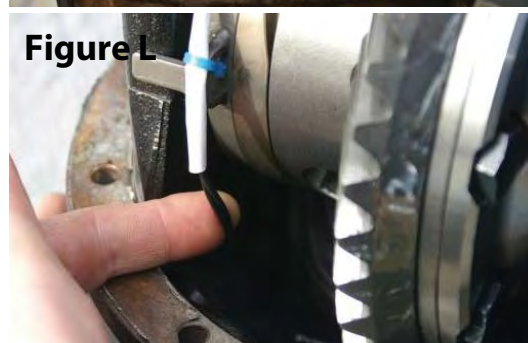
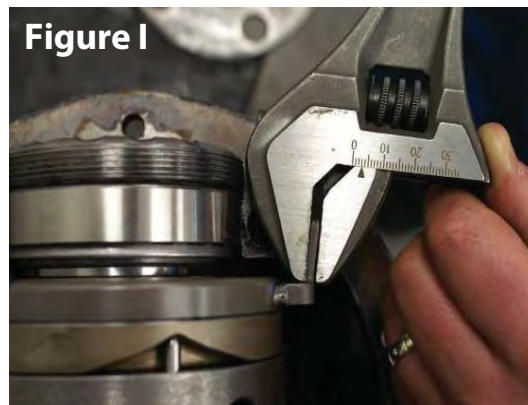

Step 27 – Complete Wiring (See Figure M & N)

Fit the weatherproof connector to the electromagnet harness.

Starting at the differential and working to the front harness, install the plastic conduit over any exposed wiring harness sections requiring protection from the likes of hot exhaust parts, sharp edges moving parts or areas vulnerable to stick or rock damage. Ensure the wiring harness is securely supported and fastened with cable ties as necessary. Cut off any excess harness and splice/crimp to the previously fitted front harness.

Note 1: The connector pin outs are not polarity sensitive and can be installed either way.

Note 2: Be certain to leave sufficient harness to provide sufficient allowance for suspension travel, use the flexible brake hose as a guide for the required length.

Step 28 – Test Electronics

Test the electronics by turning on the ignition in the vehicle. Activate the ELocker switch to the “ON” position. Rotate the drive shaft a minimum of one full revolution while attempting to hold one wheel stationary. While the drive shaft is being turned, you should feel the wheel that is being held stationary “lock” as both wheels begin to rotate together. If lock-up is not evident, check to confirm proper electrical connections.

Step 29 – Lower Vehicle

Take account of all tools and components. Lower the vehicle to the ground.

Step 30 – Test ELocker Differential

Activate the ELocker differential by pressing the dash mounted push button switch. Observe that the indicator lamp is lit when the ELocker differential is activated. Turn the steering wheel all the way to the left and drive in tight circles on loose soil. Observe the bind-up or wheel scrub while circling when the ELocker differential is activated. This confirms proper functionality.

Your newly installed ELocker differential is ready to be used responsibly.

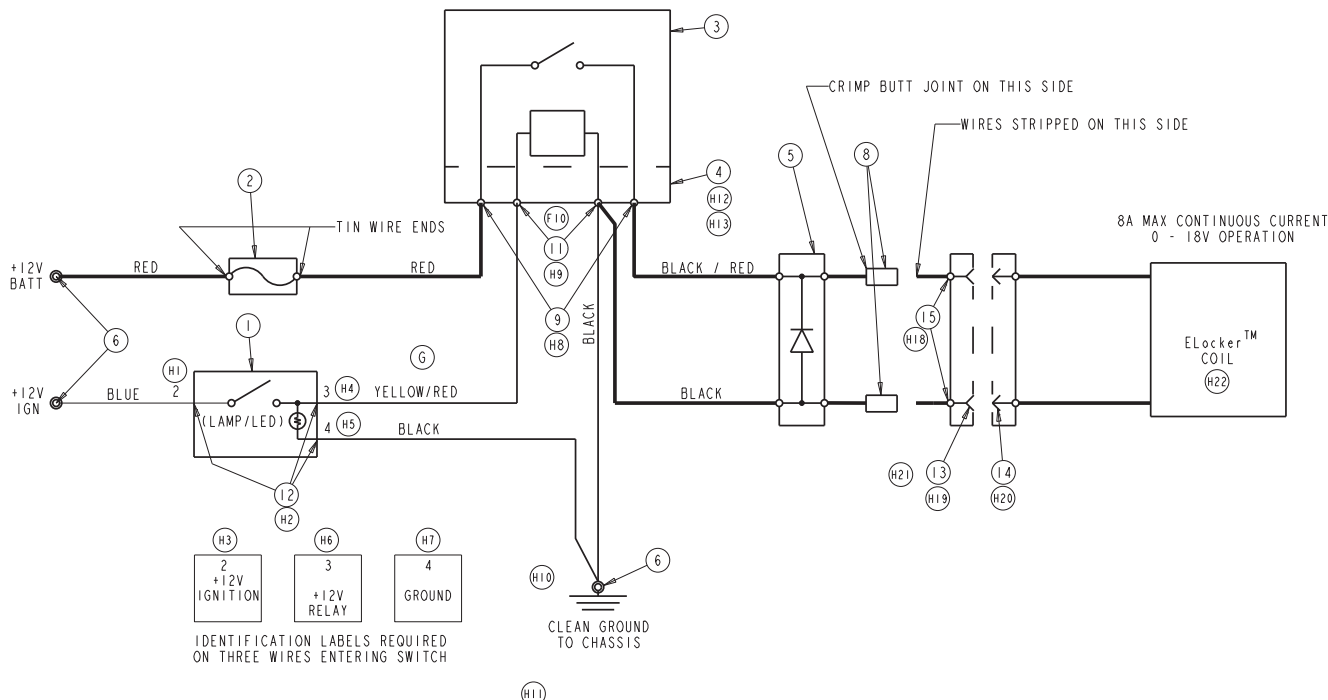
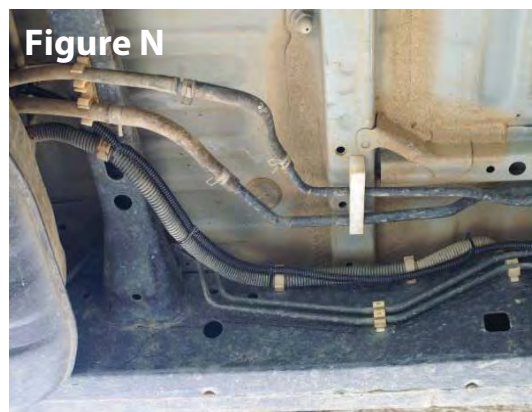

WIRE INFORMATION				
DESCRIPTION	GAGE	LENGTH	COLOR	WIRE TYPE
RELAY DEVICE TO BUTT JOINT	16 AWG	8-12in	BLACK/RED, BLACK	GXL
+12V RELAY TO SUPPRESSION DEVICE	16 AWG	4-6in	BLACK/RED	GXL
GND RELAY TO SUPPRESSION DEVICE	16 AWG	4-6in	BLACK	GXL
GND HEADER TO RELAY	16 AWG	3ft	BLACK	GXL
BUTT JOINT (GND) TO DEVICE	16 AWG	17ft	BLACK	GXL
BUTT JOINT TO +12V DEVICE	16 AWG	17ft	BLACK/RED	GXL
GND TO SWITCH	18 AWG	3ft	BLACK	TXL
+OUT SWITCH TO RELAY	18 AWG	6ft	BLUE	TXL
+12V IGN TO SWITCH	18 AWG	13ft	BLUE	TXL
+12V BATT TO RELAY	16 AWG	10ft (FUSE 6in FROM RELAY)	RED	TXL

HARROP EATON ELOCKER – ADDITIONAL INSTALL GUIDE INFOMATION

Why an understanding of the differential assembly is important.

Installation of certain Elockers vary in difficulty depending on the vehicle model and its suspension layout, also differential access can vary greatly and can require the use of expert personal and or specialized tools. The use of independent suspension on current off road vehicles has also made installation more difficult on certain models. Diff housings known as a clamshell assembly should not be attempted unless you have sound experience, an understanding of how a differential works and are capable of accurately setting backlash. Once the clam shell the housing is sealed you have no access to the diff centre.



For this reason absolute care must be taken to insure that the installation is correct. Backlash setting and ensuring that the electro-magnet stop is correctly installed will insure trouble free operation. Incorrect assembly could cause the unit to be damaged, the vehicle may be un-driveable and/or be a hazard to occupants and other road users. A lot of care is taken when manufacturing our Elocker range. The Elocker is manufactured to fine tolerances so that there is minimal variation from OEM specification, 0.13mm (0.005”) is enough to damage a crown wheel and pinion or cause a noisy installation. This is why backlash setting is critical and has to be adjusted every time a component in the assembly is changed or replaced.

Because of the clam shell type arrangement proper location of the electromagnet stop does require some modification to the diff housing. We have tried to limit the amount of modification required, so that the installation remains simple and does not require many specialised tools. It requires some grinding to locate the magnet stop as shown in the attached images. Be sure to clean the housing of any grinding debris, any dirt or grit in the housing will cause the unit to malfunction.

Housing shown below is to suit E-LOCKER

#A11167

- **READ ALL NOTES COMPLETELY BEFORE STARTING INSTALLATION DO NOT MOUNT BEARINGS TO THE CENTRE.**
- Grind away a small section of the rib until the electromagnet does not interfere with the diff housing as shown below.



Grind as shown



Electromagnet shown in position



- When installing the A11167 E-LOCKER it is necessary to remove the electromagnet from the centre in order to assemble the crown wheel therefore we do not assemble the electromagnet assembly, it is up to the installer to complete this process.
- After installing the crown wheel sit the unit on bench upright as shown, install the 3 pins as shown with the radiuses protruding



- After the pins have been fitted install the ramp plate, you will notice the pins aren't evenly spaced, rotate the plate until all 3 pins are sitting in the ramp.



- Now place the bearing thrust washer on the ramp plate followed by the electromagnet and the bearing race.



- To retain this all in place you must press on the bearing spacer as shown



- Now you can mount your bearings to the centre and continue with the installation

Housing shown below is to suit E-LOCKER

#A11412

- READ ALL NOTES COMPLETELY BEFORE STARTING INSTALLATION DO NOT MOUNT BEARINGS TO THE CENTRE.
- Grind away a small section of the boss around the bolt hole until the electromagnet does not interfere with the diff housing as shown below. Also grind other side for case clearance.

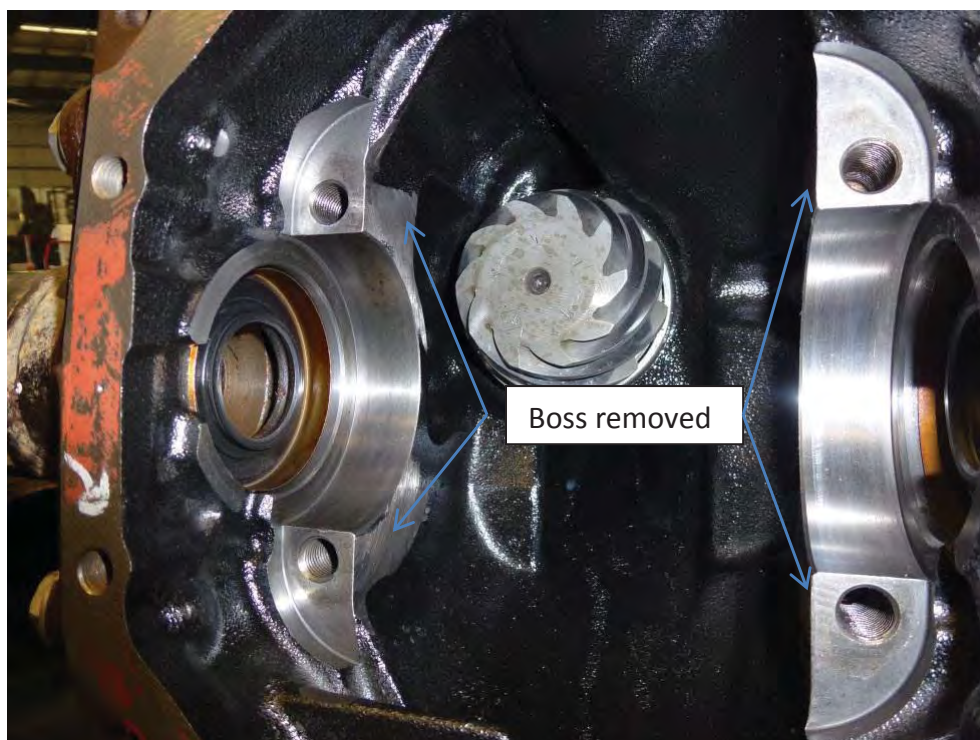
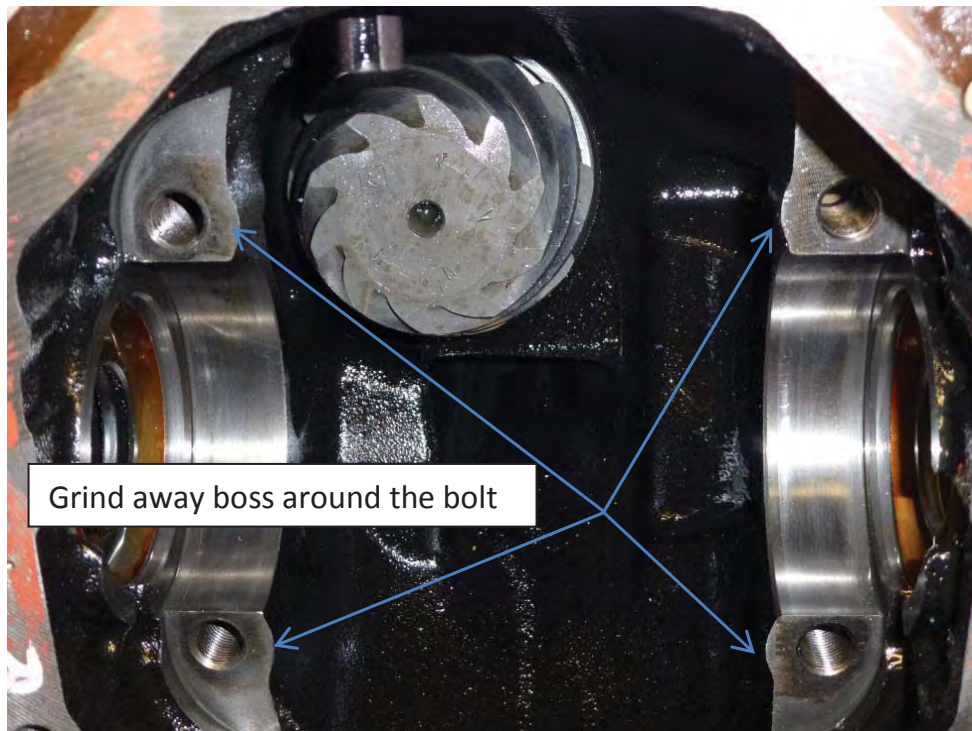

- **Installing the crown wheel and bearings**



- When installing the A11412 E-LOCKER it is necessary to remove the electromagnet from the centre in order to assemble the crown wheel therefore we do not assemble the electromagnet assembly, it is up to the installer to complete this process.
- After installing the crown wheel sit the unit on bench upright as shown, install the 3 pins as shown with the radiuses protruding .



- After the pins have been fitted install the ramp plate, you will notice the pins aren't evenly spaced, rotate the plate until all 3 pins are sitting in the ramp.



- Now place the bearing thrust washer on the ramp plate followed by the electromagnet and the bearing race.



- To retain this all in place you must press on the bearing spacer as shown



- Now you can mount your bearings to the centre and continue with the installation

Housing shown below is to suit E-LOCKER**#A10994-A11110**

- Grind away a small section of the rib until the electromagnet does not interfere with the diff housing as shown below.
- Grind only as much as needed, the rib also acts as the stop for the electromagnet and if too much is ground away there will be no stop left in the housing.

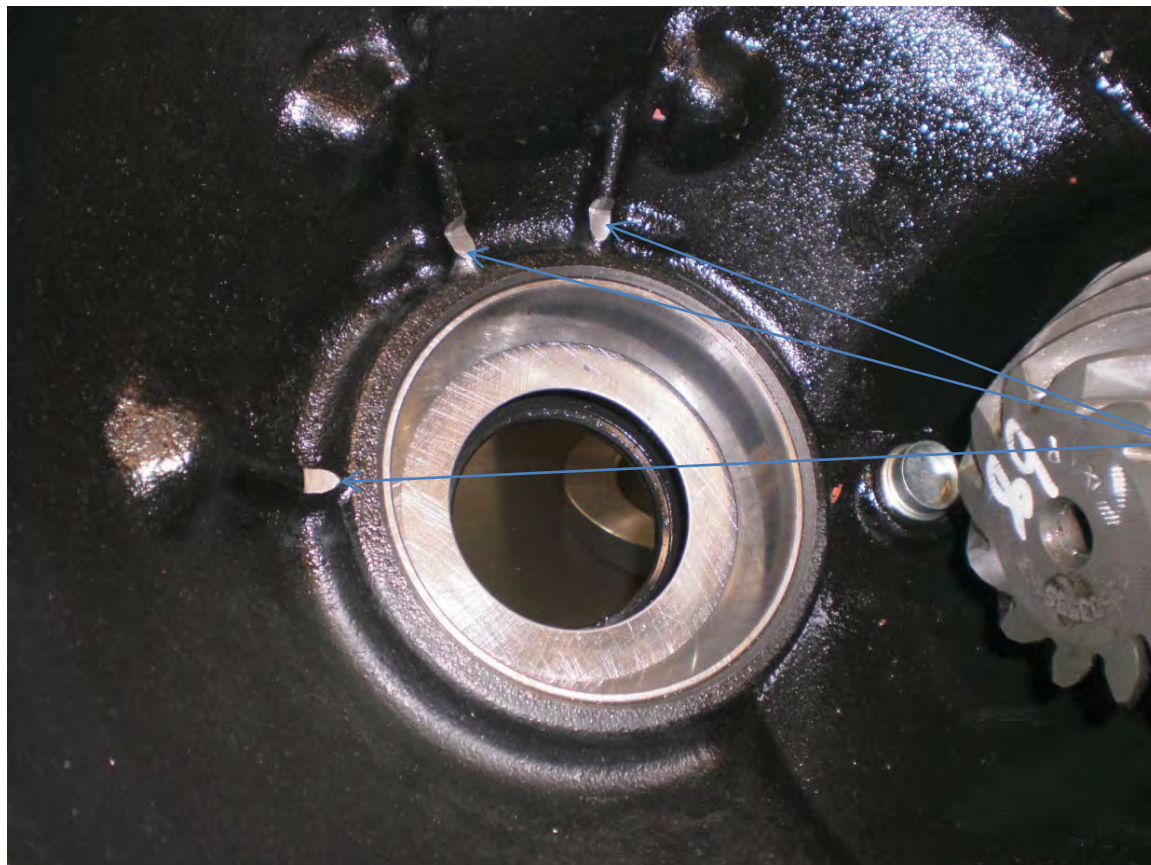

Grind as shown

Housing shown below is to suit E-LOCKER

#A11250

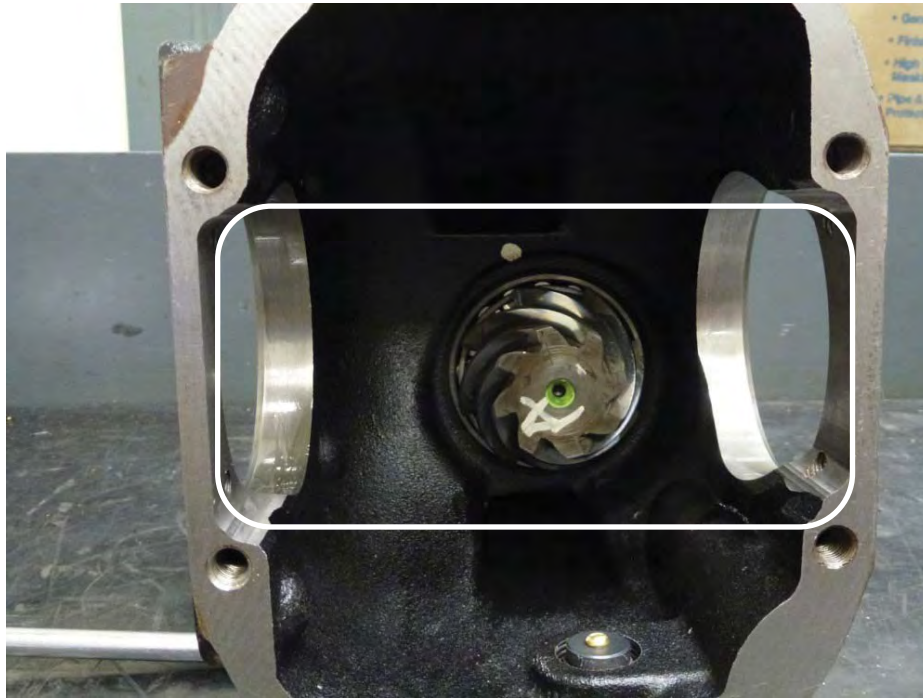

Due to the physical size of the E-locker and the position of the electromagnet, it is not possible to rotate the centre into the diff housing. Therefore, additional material must be removed from the housing. It may seem excessive in the picture but you are only removing 2-3mm from each side of the housing in an area, which is only as cast. This can be done in a manual milling machine or can be carefully ground out using an angle grinder and a die grinder. The width of the opening is a rectangle 157mm wide by 70mm high with about a 6mm radius in the corners.



The cut out is so you can just slide in the centre with the bearings assembled as in the picture above. There needs to be clearance around the electromagnet tab so it doesn't touch the housing. The height of the tab needs to be below the mating surface of the housing and the cover. If the tab is above or the cover is not fully machined in this area grinding may be required. The electromagnet tab must not be locked or jammed up against the housing or the cover. This may cause the locker not to engage or disengage correctly. Silastic or some type of sealant is required around the bolts to stop oil from seeping past the threads that retain the side adjuster bearing housings.



Clearance
around the tab

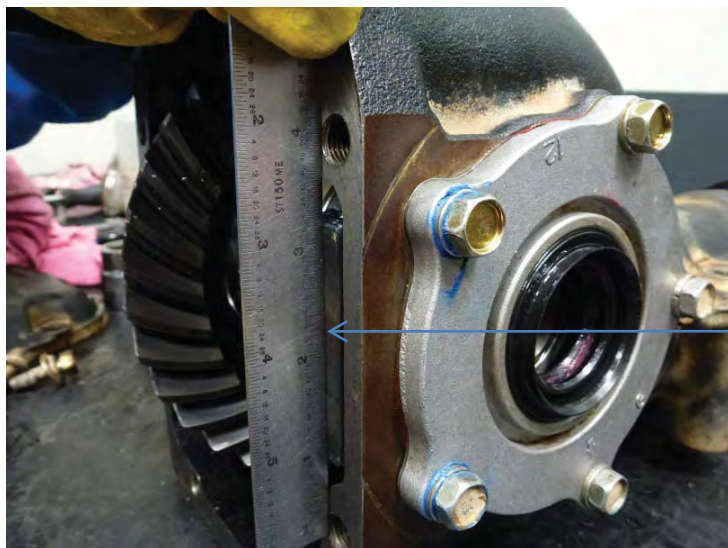

Tab must be below
this surface

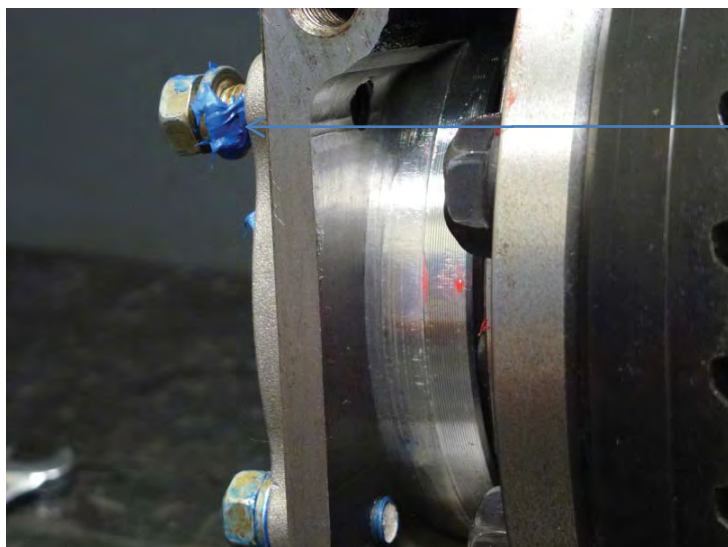

Silastic or sealant
around bolt

Housing shown below is to suit E-LOCKER

#A11120



- When installing the A11120 E-LOCKER it is necessary to remove the electromagnet from the centre in order to assemble the crown wheel therefore we do not assemble the electromagnet assembly, it is up to the installer to complete this process.
- After installing the crown wheel (crown wheel not shown) sit the unit on a bench upright as shown, install the 3 pins as shown with the radiuses protruding .



- After the pins have been fitted install the ramp plate, you will notice the pins aren't evenly spaced, rotate the plate until all 3 pins are sitting in the ramp.



- Now place the bearing thrust washer on the ramp plate followed by the electromagnet and the bearing race.



- To retain this all in place you must assemble the circlip as shown



- Now you can mount your bearings to the centre and continue with the installation

Housing shown below is to suit E-LOCKER

#A11887

MODIFICATION TO THE BEARING SHIMS

This unit requires a bearing upgrade and some modification to the diff. preload shims. Because of the bearing upgrade the bearing journal is larger in diameter and the I.D. of the bearing rubs on the standard shim if you are able to source some shims with a larger I.D. the modification is not required.

The bearing required for the upgrade is LM102949 cone and LM102910 cup.



Shims above are standard note that one side of the shim has a chamfer on the I.D. and O.D. this side is not to be modified, the modification is required on the flat side.



A counter bore of $\text{Ø}63.0\text{-}\text{Ø}64.0$ by 0.50mm to 1.0mm deep as shown above. When re-assembling into the housing the chamfered side of the shim faces the diff housing and the counter bored side goes against the bearing.

MODIFICATION TO THE BREATHER BAFFLE

A modification to the breather baffle is required to clear the locking tabs of the electromagnet. This diff is fitted with a baffle it is not recommended that the baffle be removed from the assembly as this may cause diff oil to feed up the breather tube.

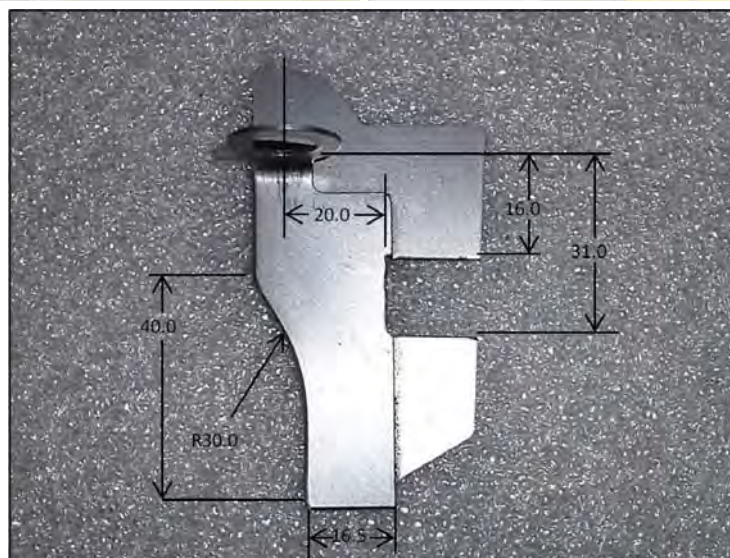
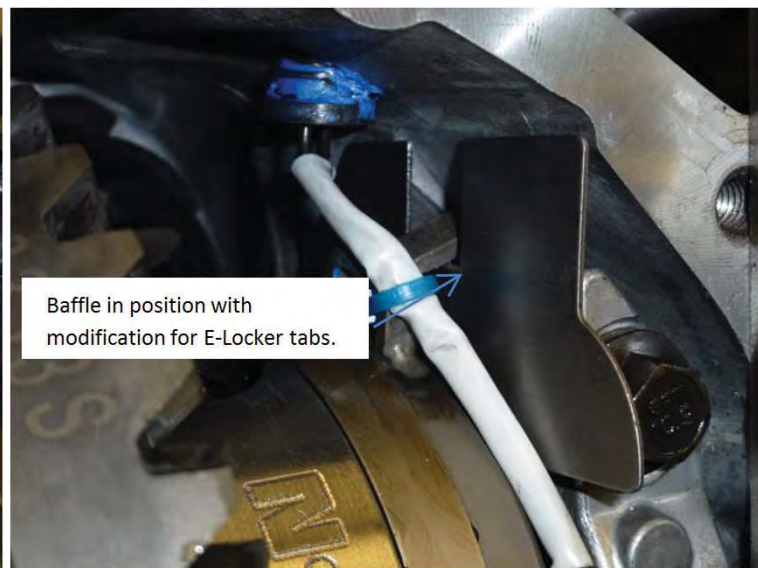
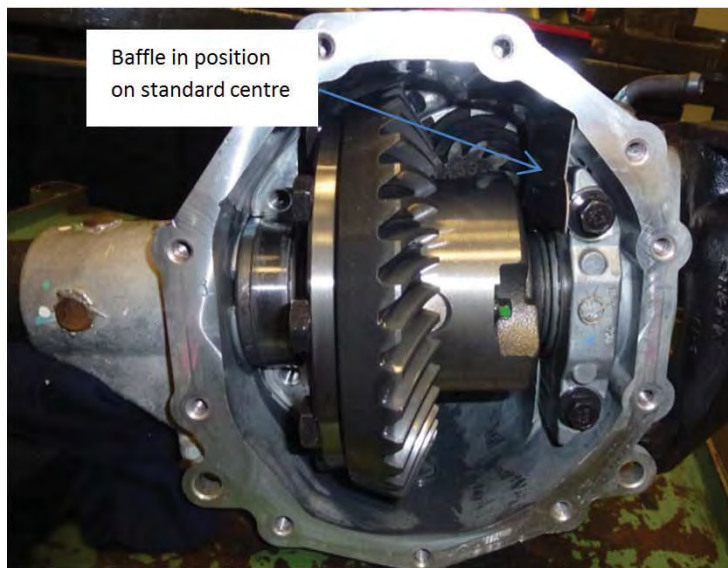

Remove material in areas shown above additional material may need to be removed depending on casting shape and how the tabs are bent, the electromagnet tabs must make contact with the bearing cap and not the baffle.

Purchase details

It is imperative the details listed below are completed and the purchase and installation receipts retained as proof of purchase to validate the warranty.

Purchased from **Location** **Date**
Installed by **Location** **Date**
Odometer
Vehicle make **Model** **Year**
VIN #
ELocker part number **Serial Number** **Location Fr or Rr**

Harrop/Eaton ELocker Warranty

This Warranty is given by Harrop Engineering Australia Pty Ltd ACN 134 196 080 (Harrop) of 96 Bell Street, Preston Victoria 3072. Telephone: +61 3 9474 0900. Email: sales@harrop.com.au

1. Definitions

In this Warranty:

1.1. Differential means:

1.1.1. differential and internal lubricated parts.

1.2. Customer means the original purchaser of the ELocker and owner of the Vehicle and, provided that notice of change of ownership of the Vehicle is given to Harrop in accordance with this Warranty, any subsequent owner of the Vehicle;

1.3. ELocker means the ELocker differential installed in the Vehicle and having the serial number set out in the Confirmation of Harrop Warranty or other warranty document issued to the Customer on installation;

1.4. Vehicle means the motor vehicle in which the ELocker is installed having the vehicle identification number set out in the Confirmation of Harrop Warranty or other warranty document issued to the Customer on installation;

1.5. Warranty Period means the period of the warranty set out in this Warranty.

1.6. Harrop Dealer means registered Harrop Dealer. Please contact Harrop for a full registered dealer listing (see clause 7).

2. Differential Warranty Scope

2.1. Harrop warrants in favour of the Customer that the Differential will under normal use be free from defect or damage caused by the installation, operation or performance of the ELocker for the period from the date of purchase of the ELocker until the earlier of:

2.1.1. 36 months from the date the purchase of the ELocker;

2.1.2. the distance travelled by the Vehicle (as determined by its odometer) exceeding 100,000 kms;

2.1.3. the expiry of any express warranty against defects in respect of the Vehicle given by the manufacturer of the Vehicle.

2.2. This Warranty will not apply unless the defect or damage is caused solely by defective materials or workmanship in or defective installation of the ELocker. In particular, the Warranty will not apply where:

2.2.1. there is any defect in materials or workmanship in the Differential or in the installation of the Driveline Components;
or

2.2.2. there is any defect in materials or workmanship in the Vehicle (excluding the ELocker or any Driveline Components)

which causes or contributes to the defect in or damage to the Driveline Components.

2.3. This Warranty does not apply to fair wear and tear of the ELocker or any Differential (being the gradual and normal reduction in performance and or operation having regard to age and usage) or to any normal or routine maintenance, calibrations, alignments and other adjustments which may be required during the Warranty Period.

2.4. This Warranty will not apply where:

2.4.1. the original purchaser does not purchase the ELocker directly from Harrop or a Harrop Dealer;

2.4.2. the ELocker is not installed in the Vehicle by Harrop or a Harrop Dealer;

2.4.3. the serial number on the ELocker is removed;

2.4.4. the ELocker or any Differential are altered or modified after installation.

2.5. If within the Warranty Period a defect in the operation of the ELocker or Differential discovered Harrop will, at Harrop's option, repair or replace the defective parts at its cost in accordance with this Warranty. If defective parts are repaired or replaced under this Warranty, the repaired or replacement parts will be covered by this Warranty only for the remainder of the Warranty Period.

2.6. No employee of Harrop or a Harrop Dealer or other agent of Harrop has authority to vary the terms of this Warranty.

3. Customer Responsibilities and Limitations on Warranty

The Customer is responsible for the proper use, service, maintenance and repair of the Vehicle. This Warranty will not apply if:

3.1. the Vehicle is serviced, maintained or repaired by any person other than a qualified motor mechanic or technician;

3.2. the Vehicle is not properly serviced in accordance with the Vehicle manufacturer's instructions or specifications at least once every 12 months or 15,000 kms (whichever occurs first);

3.3. lubricants or coolants other than those recommended or approved by the manufacturer of the Vehicle are used in the Vehicle or are used otherwise than in accordance with the Vehicle manufacturer's instructions or specifications;

3.4. fuel other than 98 Octane Premium or fuel with a minimum octane level of 95 is used in the Vehicle;

3.5. the Vehicle is stored, handled, maintained or repaired in any way contrary to the manufacturer's instructions or specifications;

3.6. the Vehicle is handled, maintained or repaired in any way contrary to Harrop's instructions or specifications;

3.7. the Vehicle is otherwise improperly stored, handled, maintained or repaired;

3.8. the Vehicle is exposed to any abnormal climate conditions or operating circumstances;

3.9. the Vehicle is subjected to misuse, neglect, accidental or deliberate damage or destruction, or act of God;

3.10. the Vehicle is used for transporting livestock or in stunt activities or motor sports (including rallying, or racing or other competitive driving, practising or testing for the same);

3.11. the Vehicle is used after any defect in the Vehicle (including the ELocker and Driveline Components) becomes apparent or would have become apparent to a reasonably prudent operator or user.

4. Claiming Under Warranty

- 4.1. In order to make a claim under this Warranty, the Customer must strictly within 14 days of becoming aware of the apparent defect contact Harrop (see clause 7 below) to obtain a Warranty Claim Form and to be notified of a location for Harrop, a Harrop PIP Dealer or other service centre nominated by Harrop to which the Vehicle should be delivered by the Customer.
- 4.2. The Vehicle must be delivered to the location notified by Harrop strictly within 14 days together with a properly completed Warranty Claim Form.
- 4.3. Harrop will not accept any warranty claims made otherwise than strictly in accordance with this Warranty.
- 4.4. If the ELocker is found to be working satisfactorily, the Customer must pay all reasonable costs of testing the Vehicle, ELocker or Differential before the Vehicle will be released to the Customer.
- 4.5. The Customer will be responsible for all costs of delivering the Vehicle to the location notified by Harrop and for collection of the Vehicle from such location and any other expenses of the Customer in claiming under this Warranty.
- 4.6. Harrop's determination as to the existence of any defect or the cause of any defect is conclusive.
- 4.7. Any parts which are replaced under this Warranty become the property of Harrop.

5. Harrop's Responsibilities on Claims Under Warranty

- 5.1. Harrop will within a reasonable period after delivery of the Vehicle under clause 4.2:
 - 5.1.1. assess the Customer's warranty claim and determine whether Harrop accepts the claim; and
 - 5.1.2. notify the Customer whether it accepts the Customer's warranty claim.
- 5.2. Harrop will at its discretion carry out or arrange the repair or replacement of the defective parts with new or refurbished parts or the replacement of the defective parts with alternative parts with the same or similar specifications.
- 5.3. Harrop will ensure that all repairs and replacements under clause 5.2 are carried out:
 - 5.3.1. within a reasonable time after the Customer is notified of the acceptance of the Customer's warranty claim; and
 - 5.3.2. by an appropriately qualified motor mechanic or technician.
- 5.4. Harrop will liaise with the Customer and the person carrying out the relevant repairs or replacements and ensure that the Customer is fully informed as to the progress and nature of the repairs and replacements carried out.
- 5.5. Harrop will be responsible for all costs in repairing or replacing defective parts under this clause and the Customer will not be issued any invoice for such costs.
- 5.6. Harrop will not be responsible for:
 - 5.6.1. any loss of profits or other indirect or consequential loss whatsoever arising from any defect;
 - 5.6.2. any loss or damage to the Vehicle occurring while the Vehicle is in transit (ie either on delivery to or collection from the location notified by Harrop);
 - 5.6.3. any loss or damage caused by any delay in assessing the Customer's claim or in repairing or replacing defective parts.

6. Change of Ownership of Vehicle

The Customer must strictly within 14 days of any change of ownership of the Vehicle, notify Harrop of such change in ownership by sending a properly completed Transfer of Warranty Form to Harrop in the manner required by that form (see clause 7 below).

7. Contacting Harrop

The Customer may contact Harrop to obtain a Warranty Claim Form or a Transfer of Warranty Form:

- 7.1. by telephone: (03) 9474 0900
- 7.2. by facsimile: (03) 9474 0999
- 7.3. by post or in person: 96 Bell Street, Preston Victoria 3072; or
- 7.4. by email: warranty@harrop.com.au

8. Application of Consumer Laws

- 8.1. The benefits of this Warranty are in addition to any other rights and remedies available to the Customer under the law.
- 8.2. Nothing in this Warranty is intended to have the effect of contracting out of any applicable provision of the Australian Consumer Law
- 8.3. The Australian Consumer Law requires the inclusion of the following statement in any warranty in respect of goods supplied to a consumer as defined under the Australian Consumer Law:

“Our goods come with guarantees that cannot be excluded under the Australian Consumer Law. You are entitled to a replacement or refund for a major failure and for compensation for any other reasonably foreseeable loss or damage. You are also entitled to have the goods repaired or replaced if the goods fail to be of acceptable quality and the failure does not amount to a major failure”

Key questions addressed**What oils should be used?**

Vehicle manufacture recommended diff oil for that vehicle. If the vehicle was originally fitted with an LSD continue to use the same type of oil.

When can the ELocker be used?

Differential engagement should occur before an obstacle is encountered. If you feel that you are in a situation that may require extra traction, it is recommended to use the ELocker differential as an anticipatory device.

Only engage the ELocker differential while the vehicle is stationary or operating at speeds of 5 km/h or less with minimal wheel slippage. Engaging the ELocker while the wheel is spinning at a high rate or the vehicle is moving at more than 5 km/h may damage the differential's engagement pins or lock collar will be considered improper or abnormal use therefore voiding the warranty. Harrop will reject warranty claims if the returned ELocker has engagement pins or lock collars damaged by operation contrary to this warning. Differential engagement should be deactivated after the difficult terrain is overcome. It is not recommended to deactivate the ELocker differential while the drivetrain has load or bind on it, such as under cornering. When the drivetrain is loaded, the ELocker differential may not immediately disengage, resulting in a locked differential when it is not desired.

Differential engagement should not be maintained at high speeds (greater than 30 km/h). A locked differential at higher speeds can cause undesirable vehicle behaviour or loss of vehicle control. The ELocker differential may be deactivated via the switch while the vehicle is in motion.

When a front or rear differential is locked, the behaviour and manoeuvrability of a vehicle is altered. Steering response and vehicle manoeuvrability may be reduced dramatically. Steering may be difficult with a front ELocker differential engaged. For this reason, a front ELocker differential should be used only at low vehicle speeds and only in 4WD mode.

Differential engagement should be used on low traction surfaces, such as those encountered in off-road use. Continuous operation of a locked differential on high traction surfaces produces unnecessary strain on drivetrain and chassis components while cornering in the vehicle. Caution should be taken when operating locked differentials on slippery terrain.

How do I unlock my ELocker if it does not disengage?

Disengage the power to the ELocker (switch it off) and drive in reverse and apply the brakes this should disengage the gear and unlock the ELocker. Also going back and forward will help disengage the ELocker by taking the bind out of the drivetrain.

Maintenance involved in Truetrac/ELocker & Detroit Locker?

The Truetrac/ELocker & Detroit Locker requires no extra maintenance. Change and inspect fluid levels as per vehicle manufacturer requirements.

Does the Truetrac/ELocker/Detroit Locker have a run in period?

The Truetrac/ELocker & Detroit Locker does not require a run in period, however a run in period may be required if you have changed crown wheel and pinion or bearings, check with the component suppliers if a run in period is required.

Things to look out for when installing unit (fitment issues)

- Check the splines in the unit supplied fit the axles or output shafts before you get too far into the installation and discover the unit is the incorrect model.
- If you are not replacing the carrier bearings make sure you can remove the old ones without damaging them.
- If you are changing bearings make sure you can source the bearings in a suitable time frame, some bearings are OEM and can't be sourced through a bearing distributor, we have found some OEM bearings aren't stocked in Australia and can take up to 2 weeks to get.
- Bolt on crown wheel to the ELocker before installing the carrier bearings, in some cases the electromagnet may have to be removed to get the crown wheel on, if you have the bearings pressed on you may not be able to remove the electromagnet.

- Bolt on crown wheel to the ELocker before installing the carrier bearings, in some cases the electromagnet may have to be removed to get the crown wheel on, if you have the bearings pressed on you may not be able to remove the electromagnet.
- Do not just replace the standard unit with the ELocker and assume the shim thicknesses will be ok (check backlash).
- Be sure to mark bearing caps or side adjusters to their correct sides.

Design features

- Electromagnetic actuation
- No need to install an air compressor system
- No need to worry about air leaks
- Does not pressurise the diff housing causing it to blow out pinion or axle seals
- No weakening of bearing cap by drill a hole through it
- Maintenance free
- 100% of available torque and sending it equally to both ends of the axle.
- Rebuildable
- No run in period