

Electronically Controlled Transmission and A/T Indicator (2GR-FKS), Engine Control (2GR-FKS)

\* 7 : Before Sep. 2018 Production  
 \* 8 : From Sep. 2018 Production

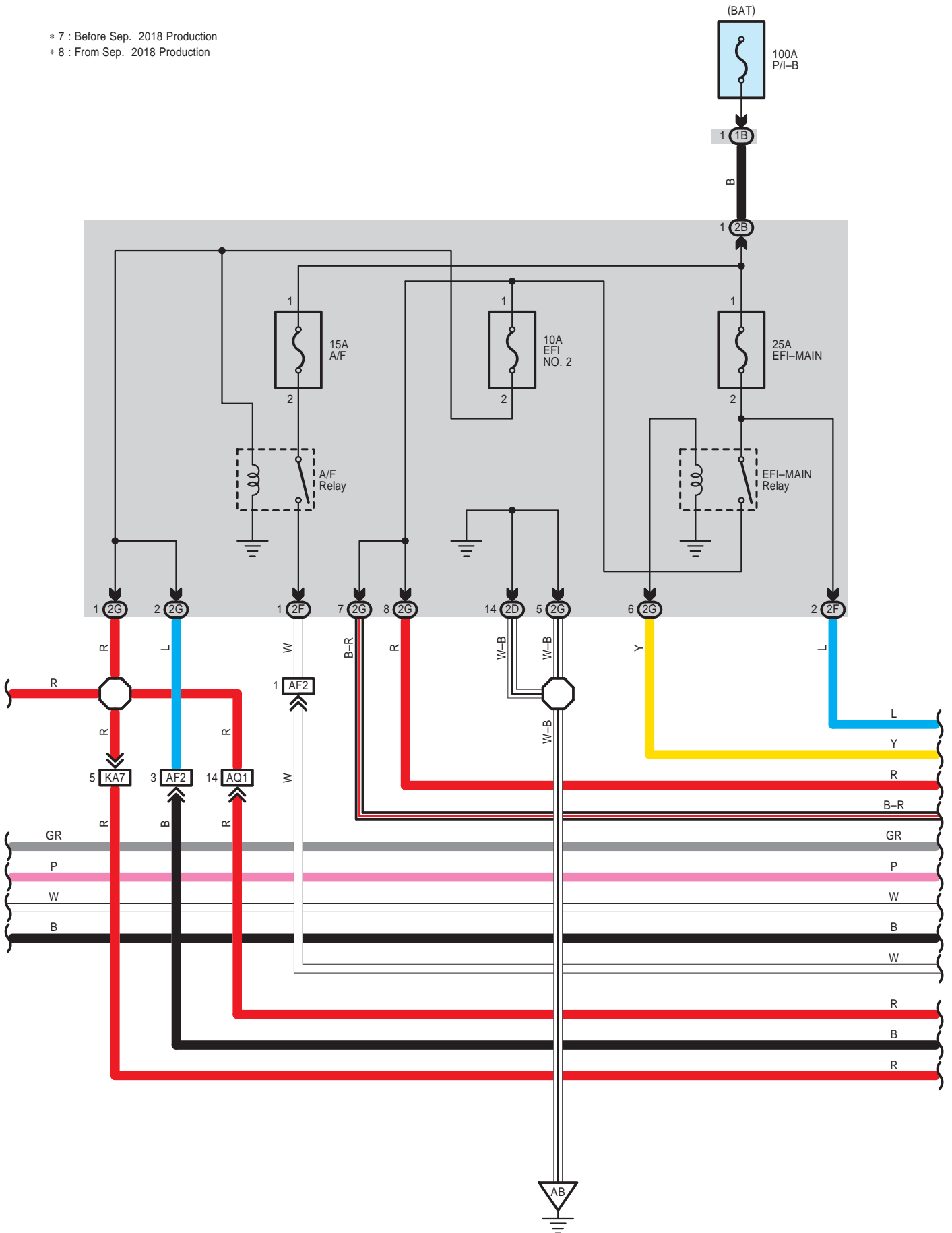

Electronically Controlled Transmission and A/T Indicator (2GR-FKS), Engine Control (2GR-FKS)

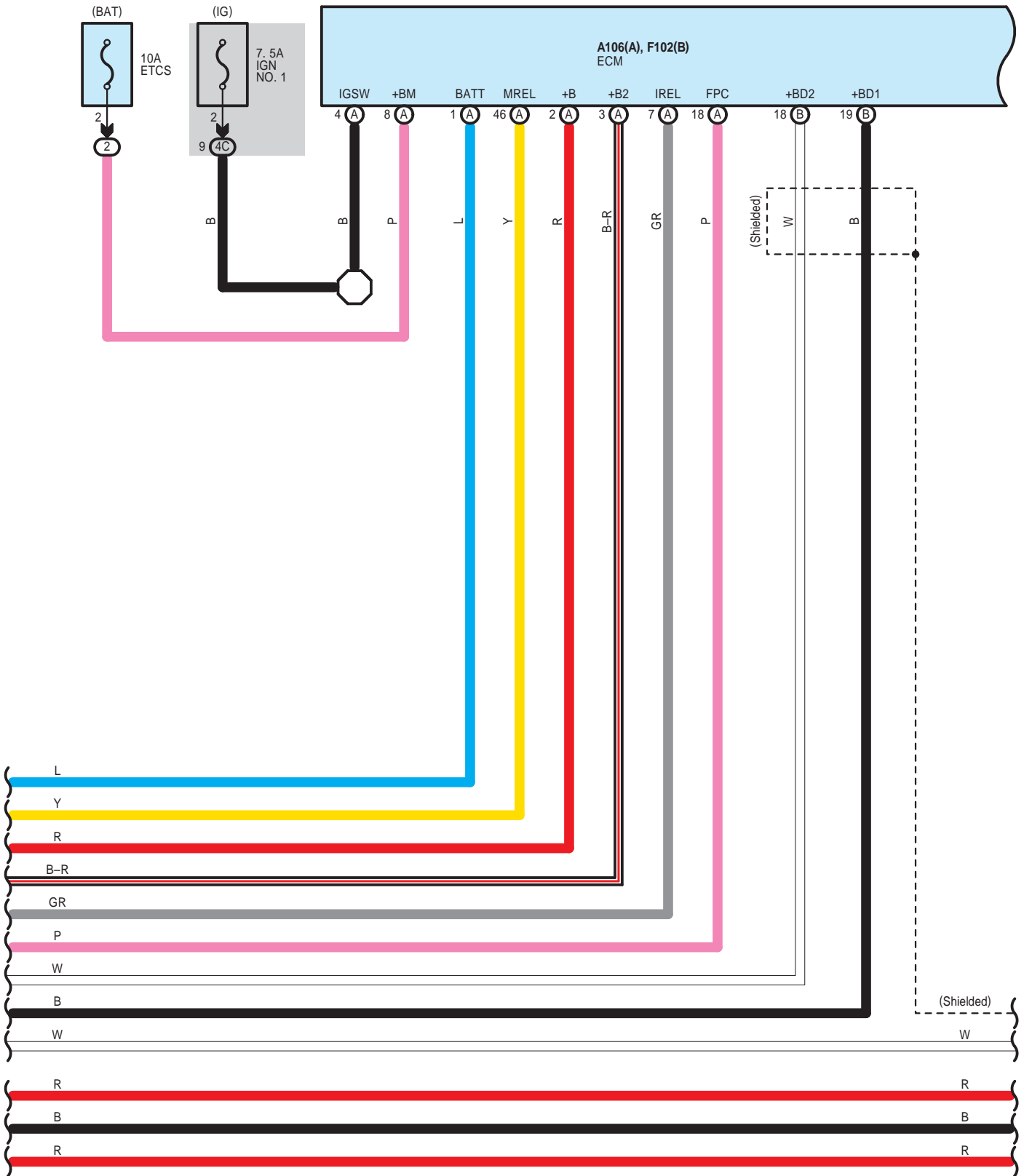

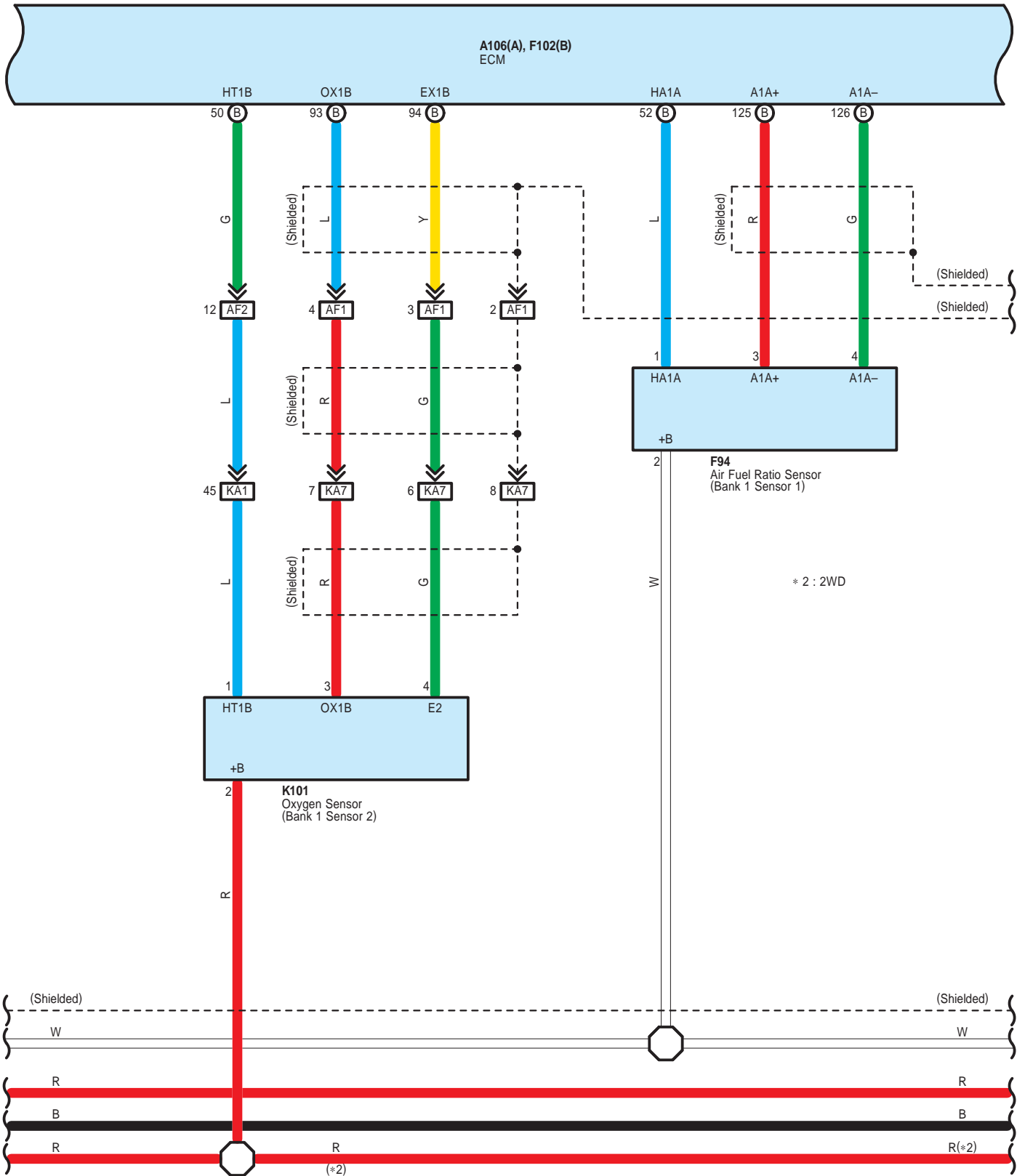

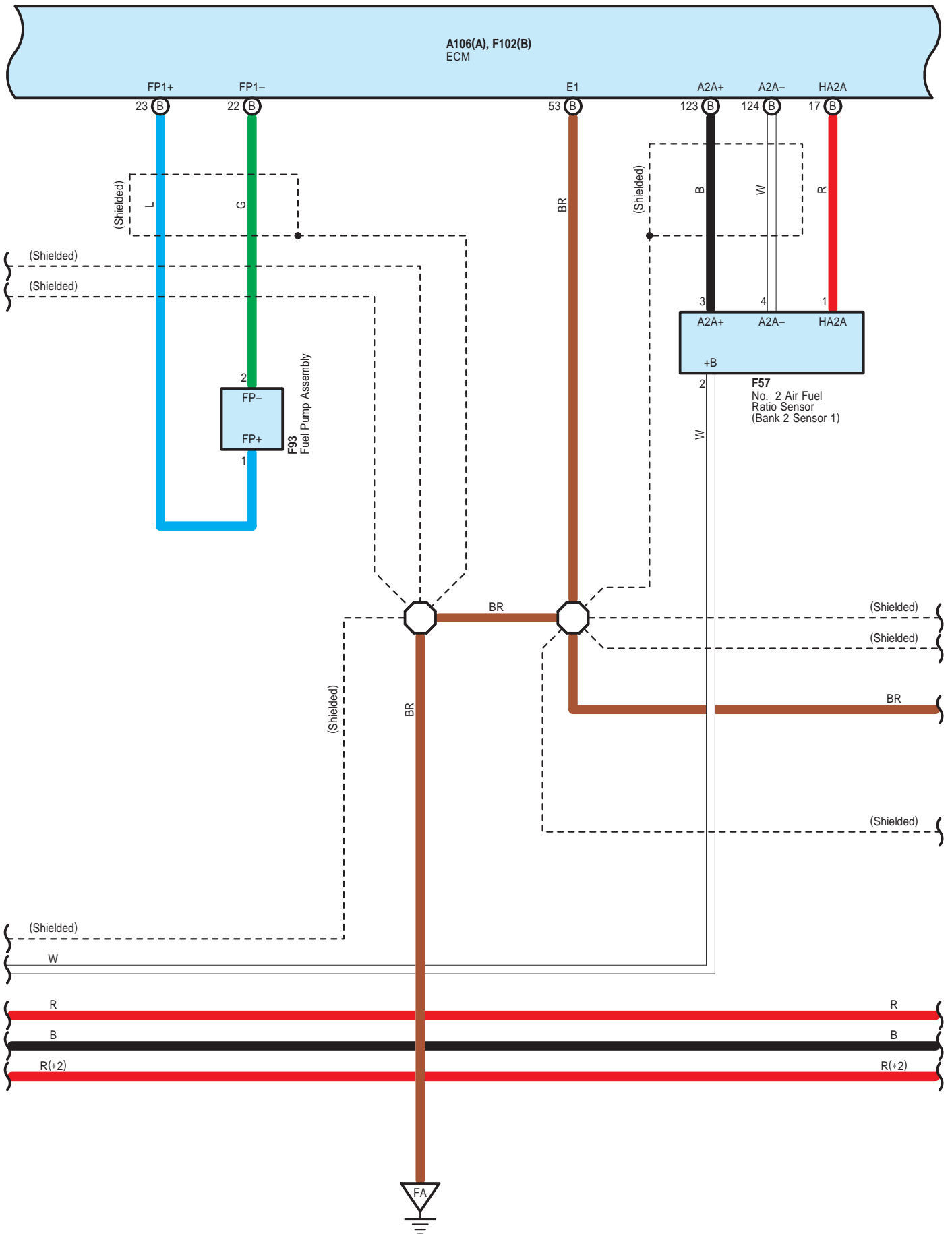

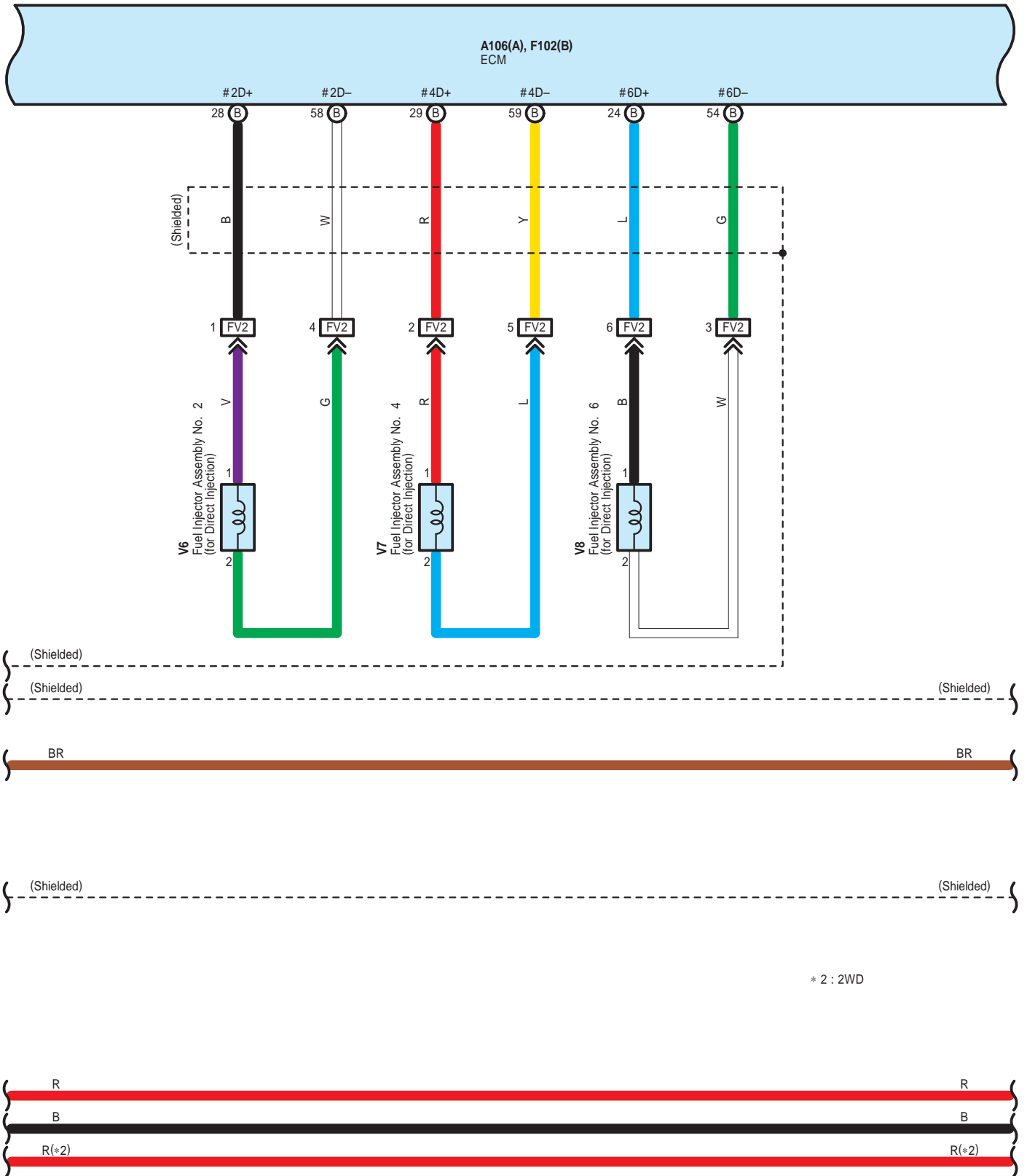

\* 2 : 2WD

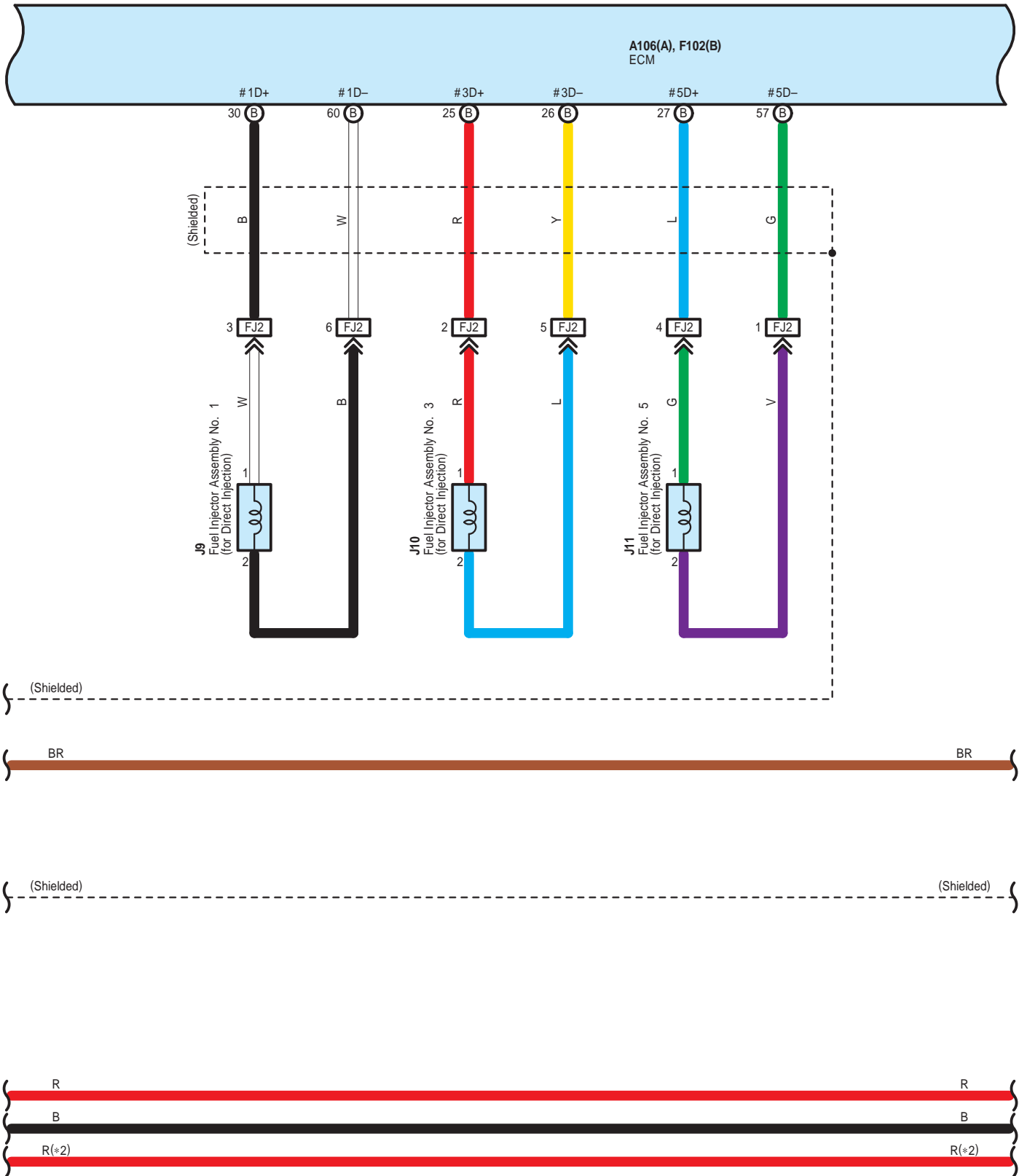

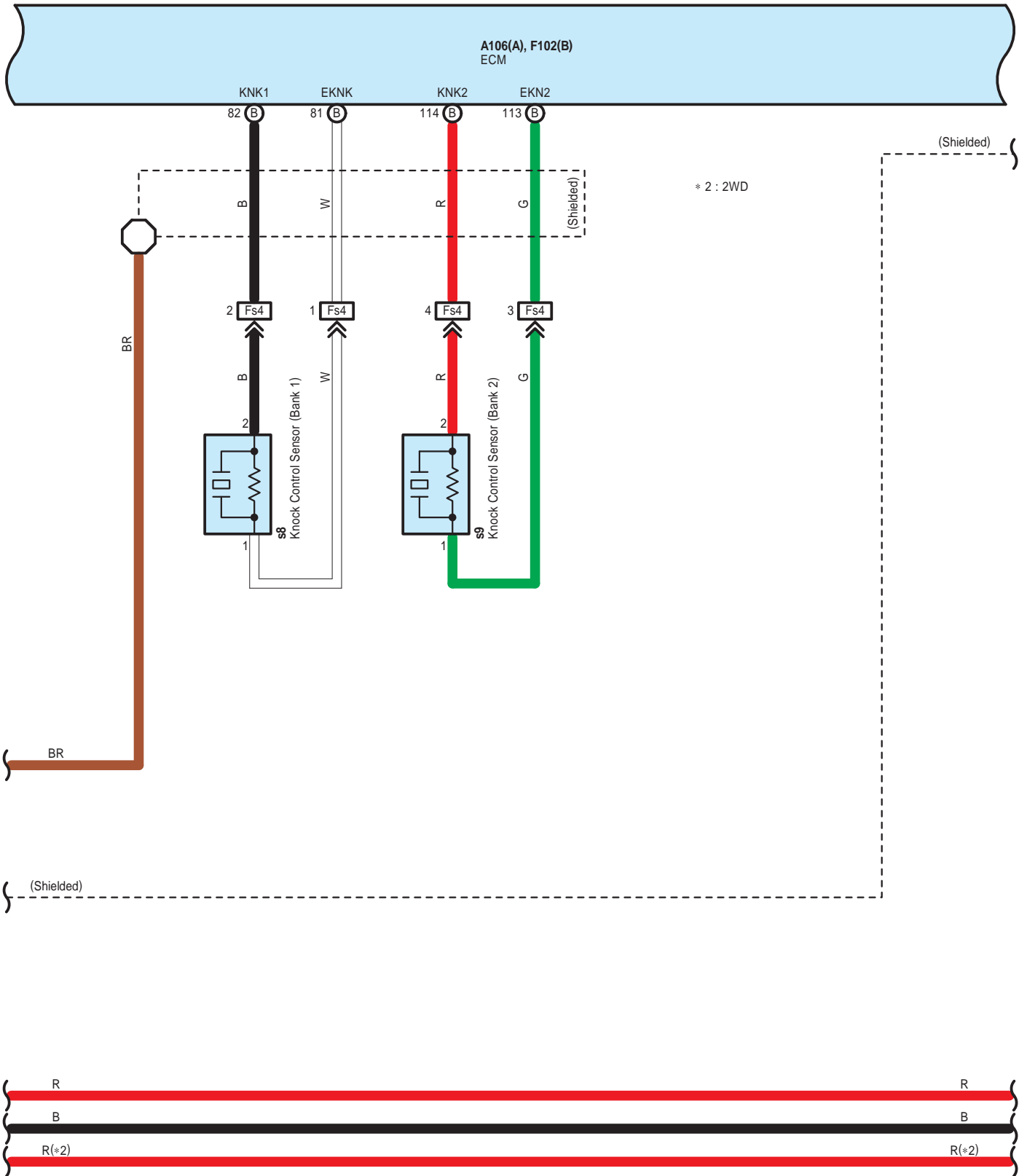



Electronically Controlled Transmission and A/T Indicator (2GR-FKS), Engine Control (2GR-FKS)

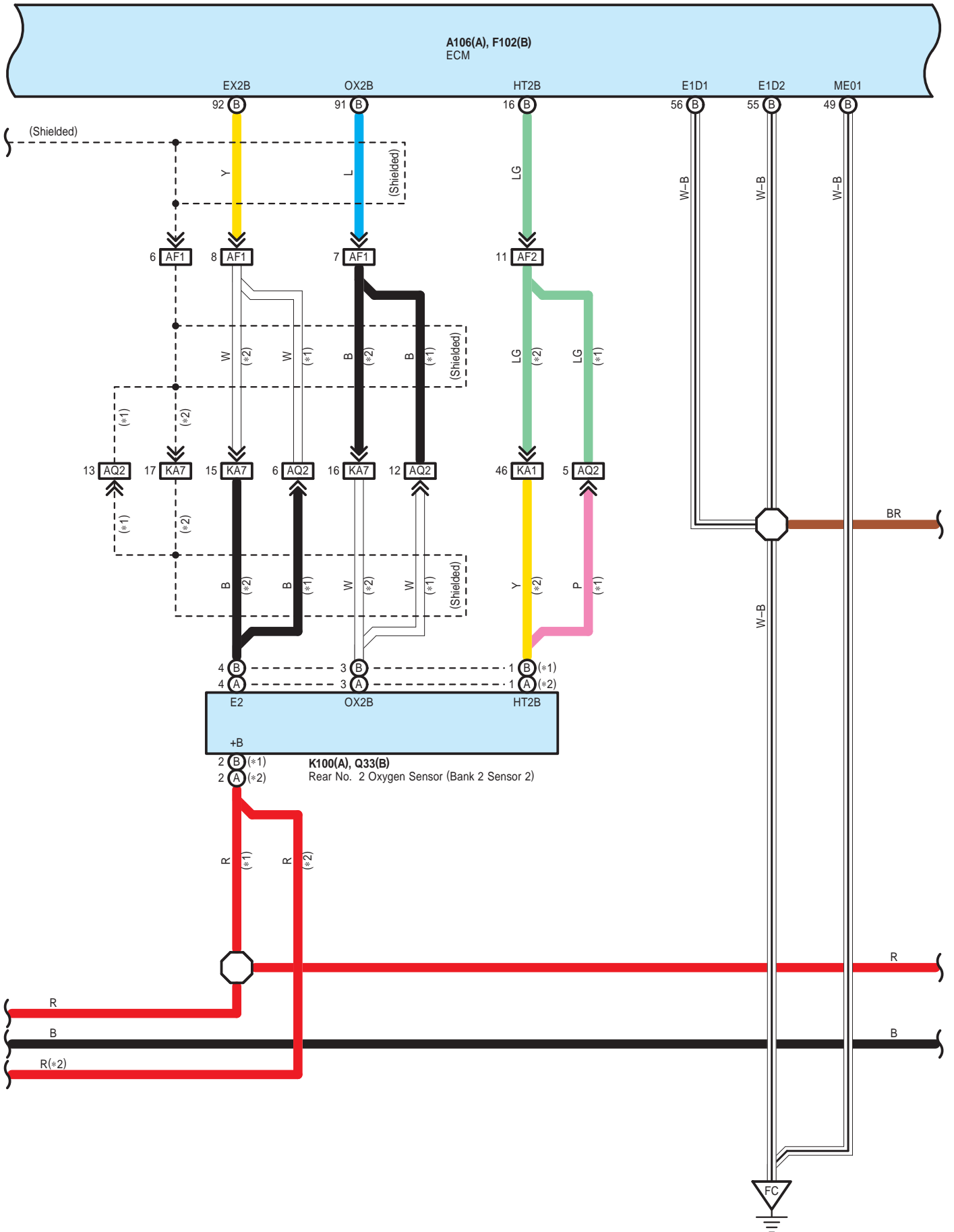

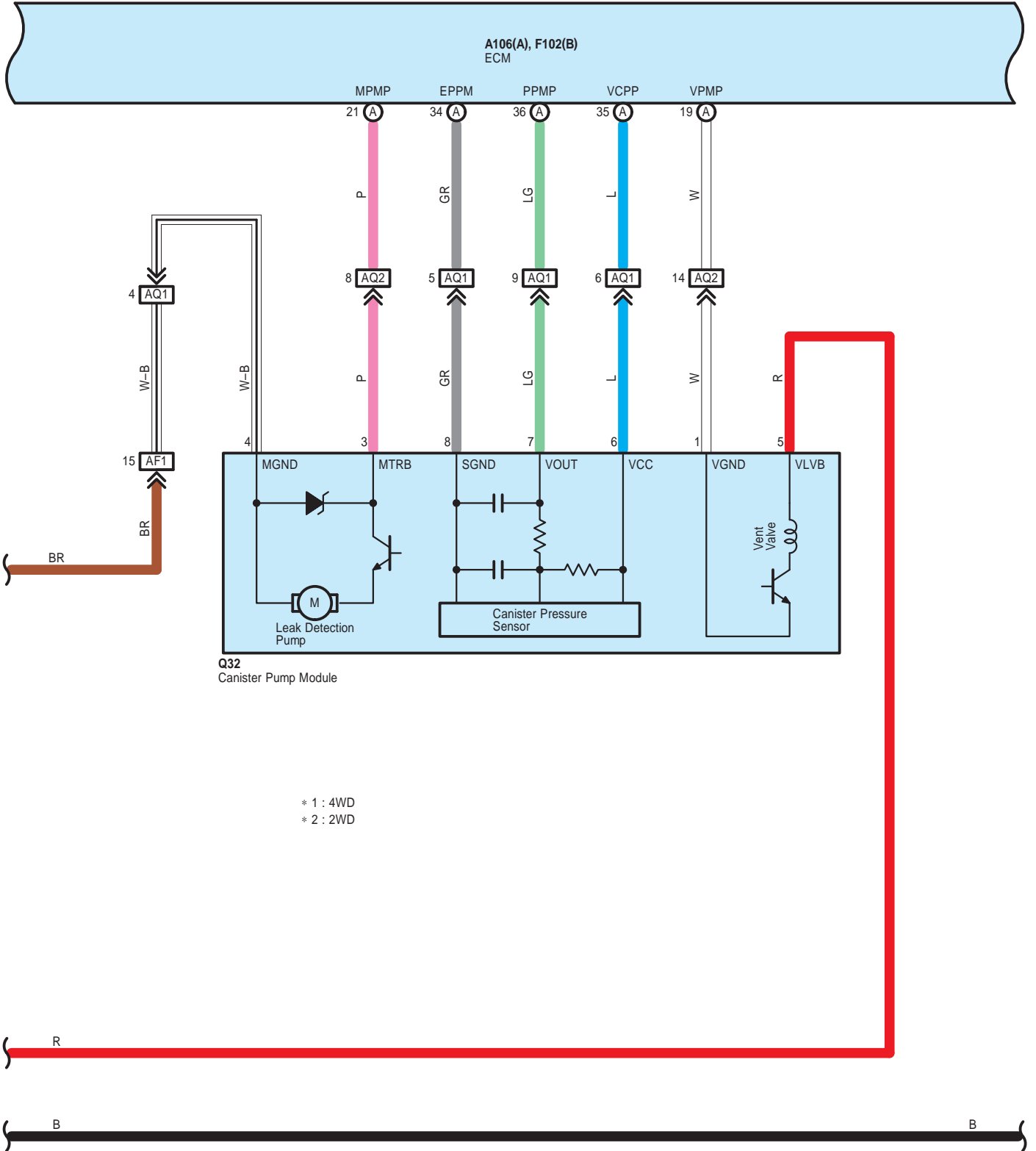

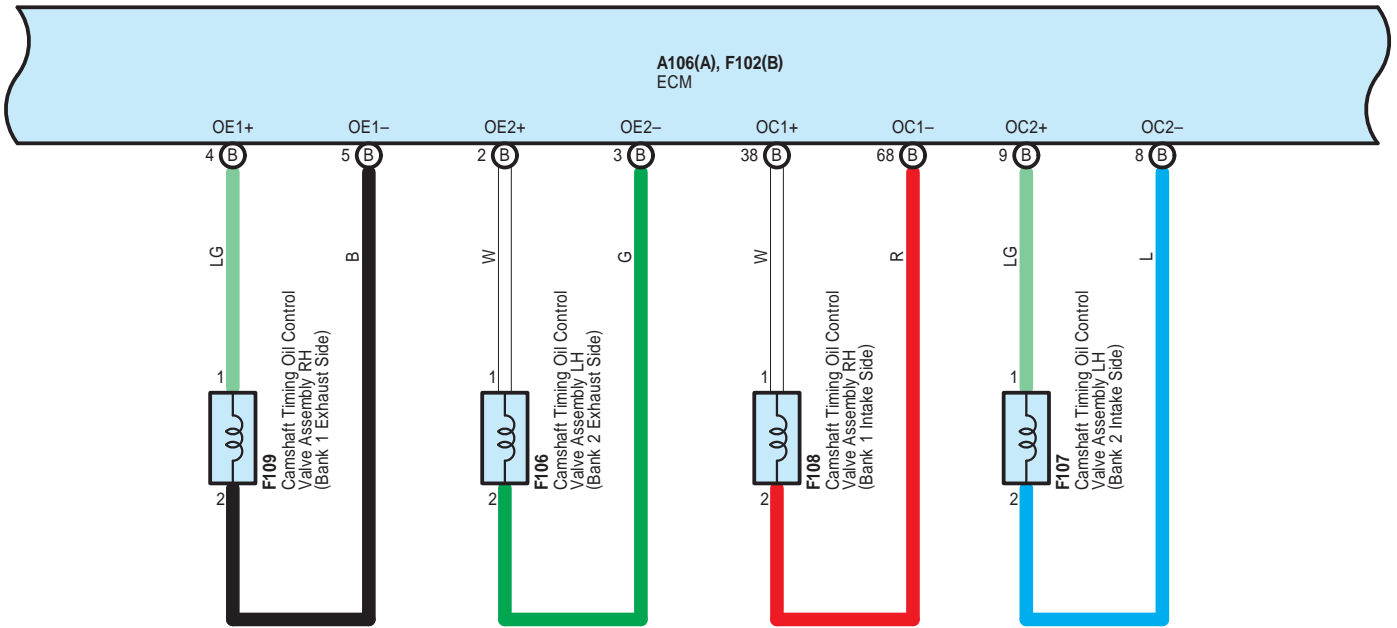

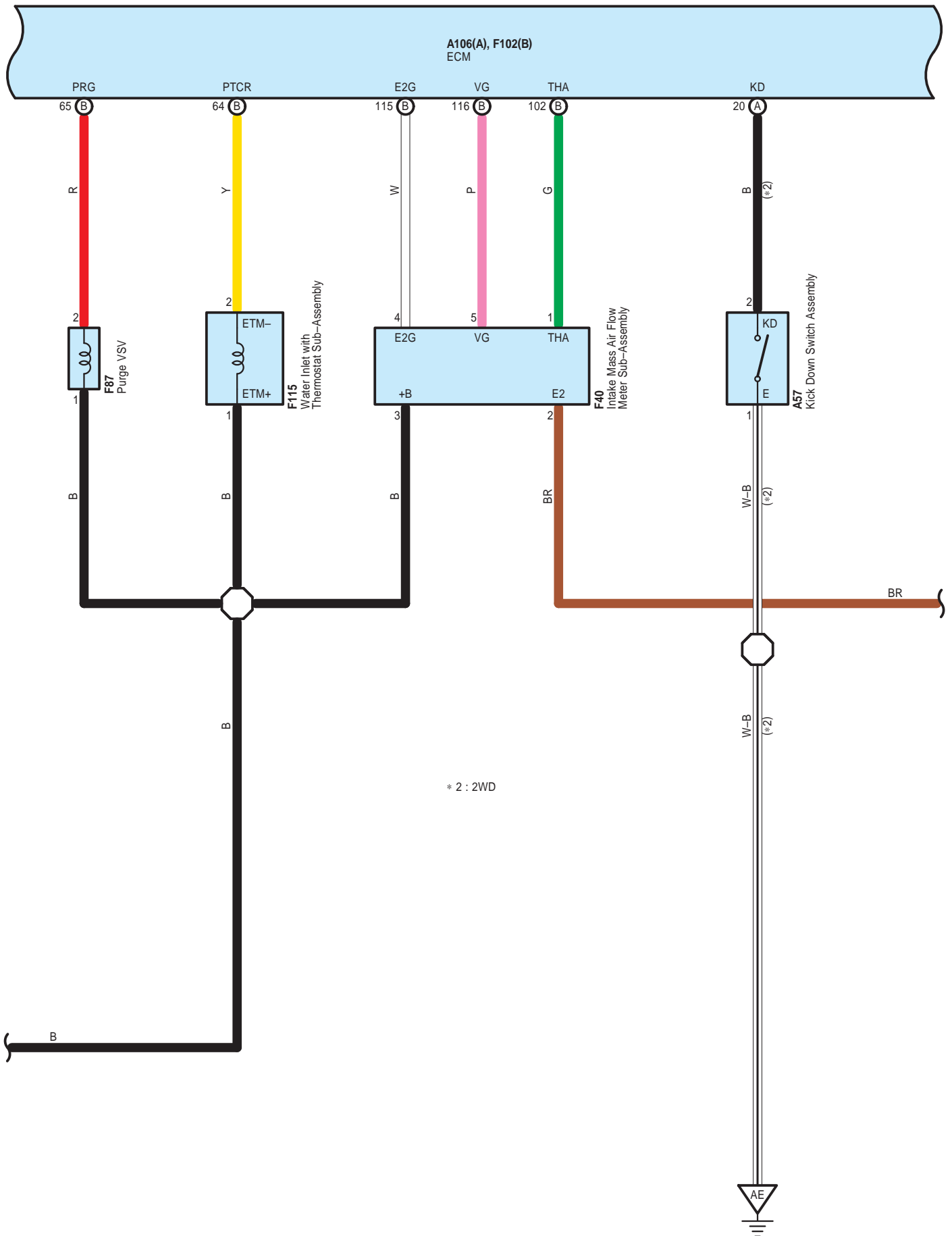

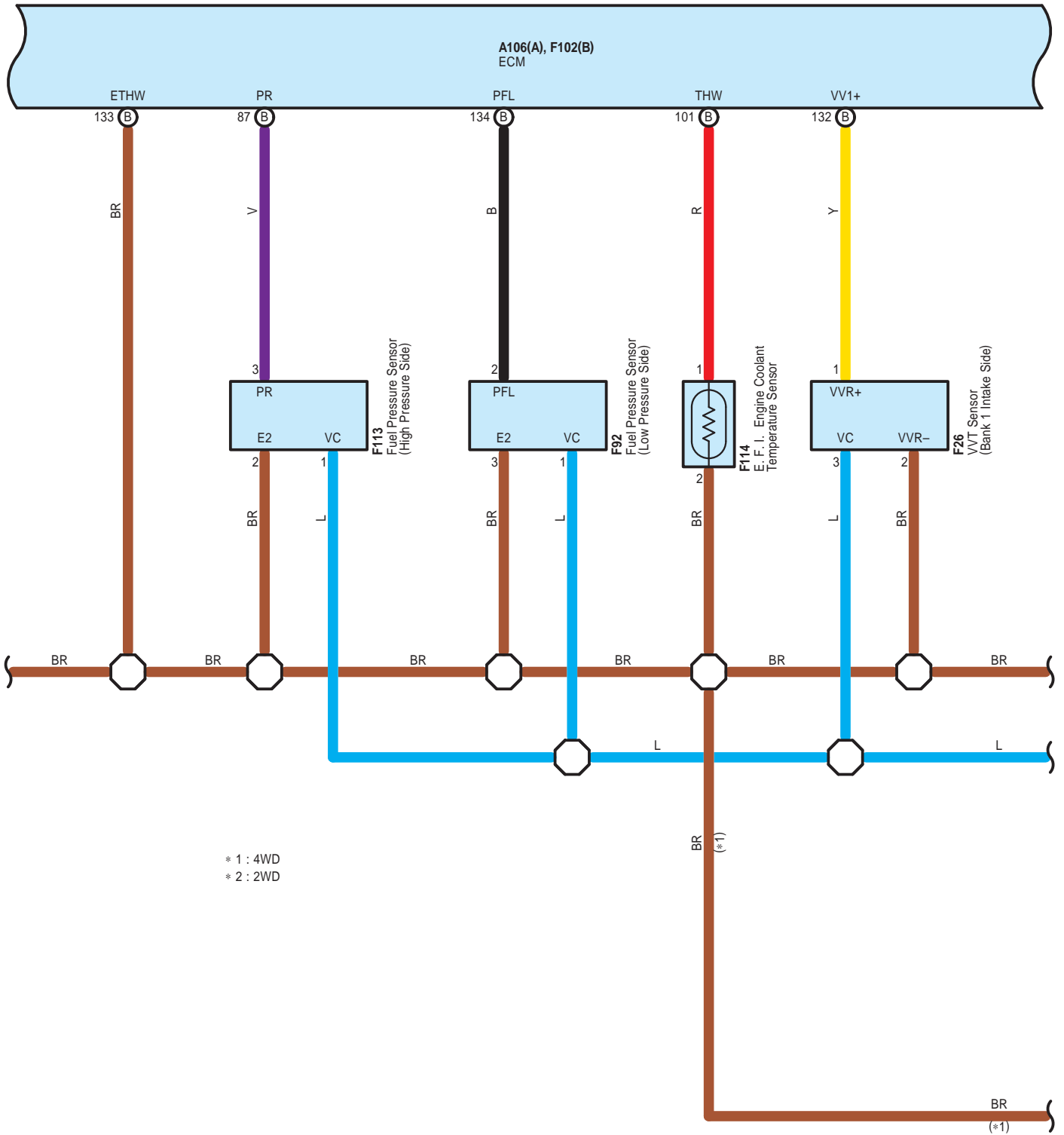

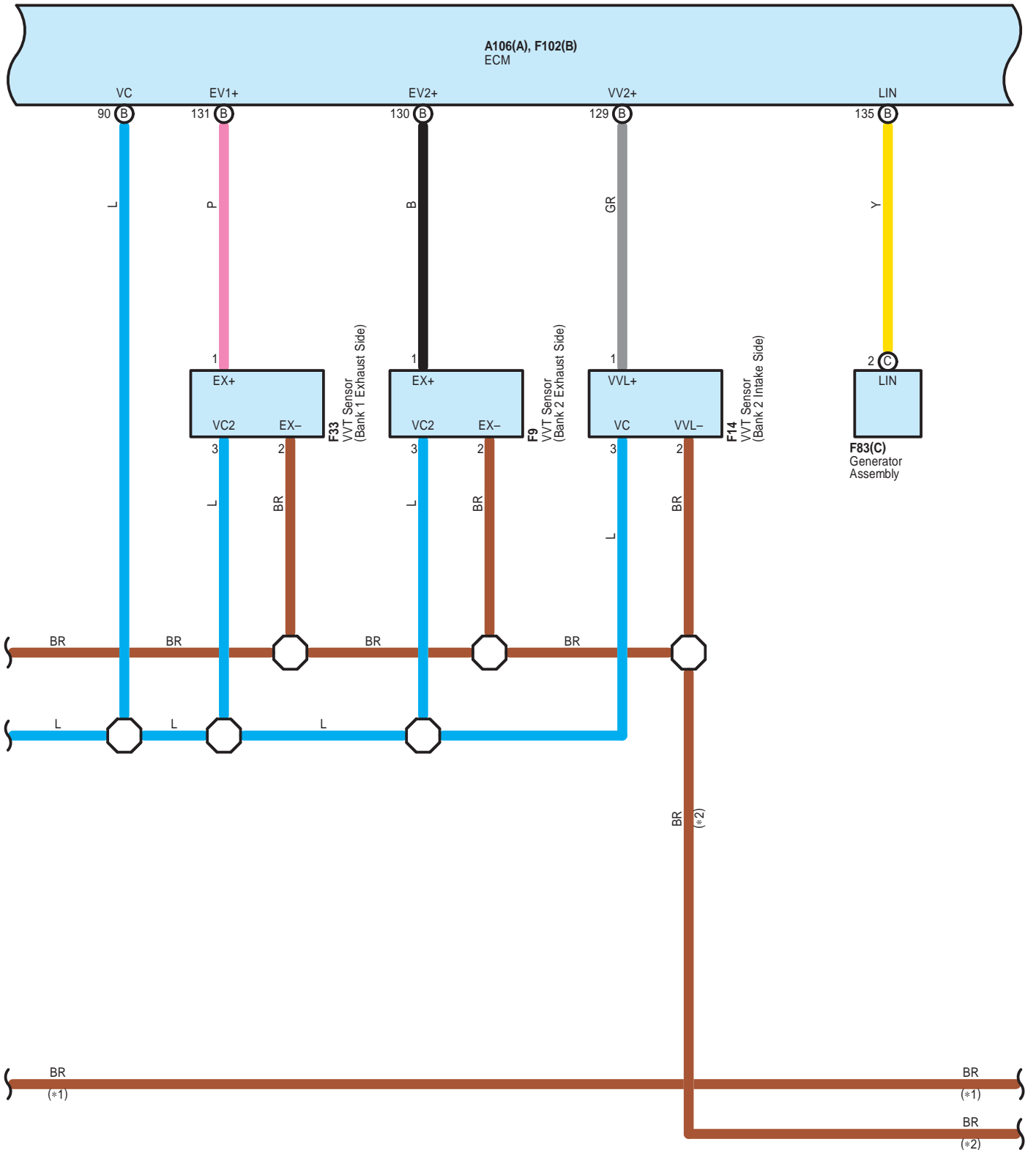

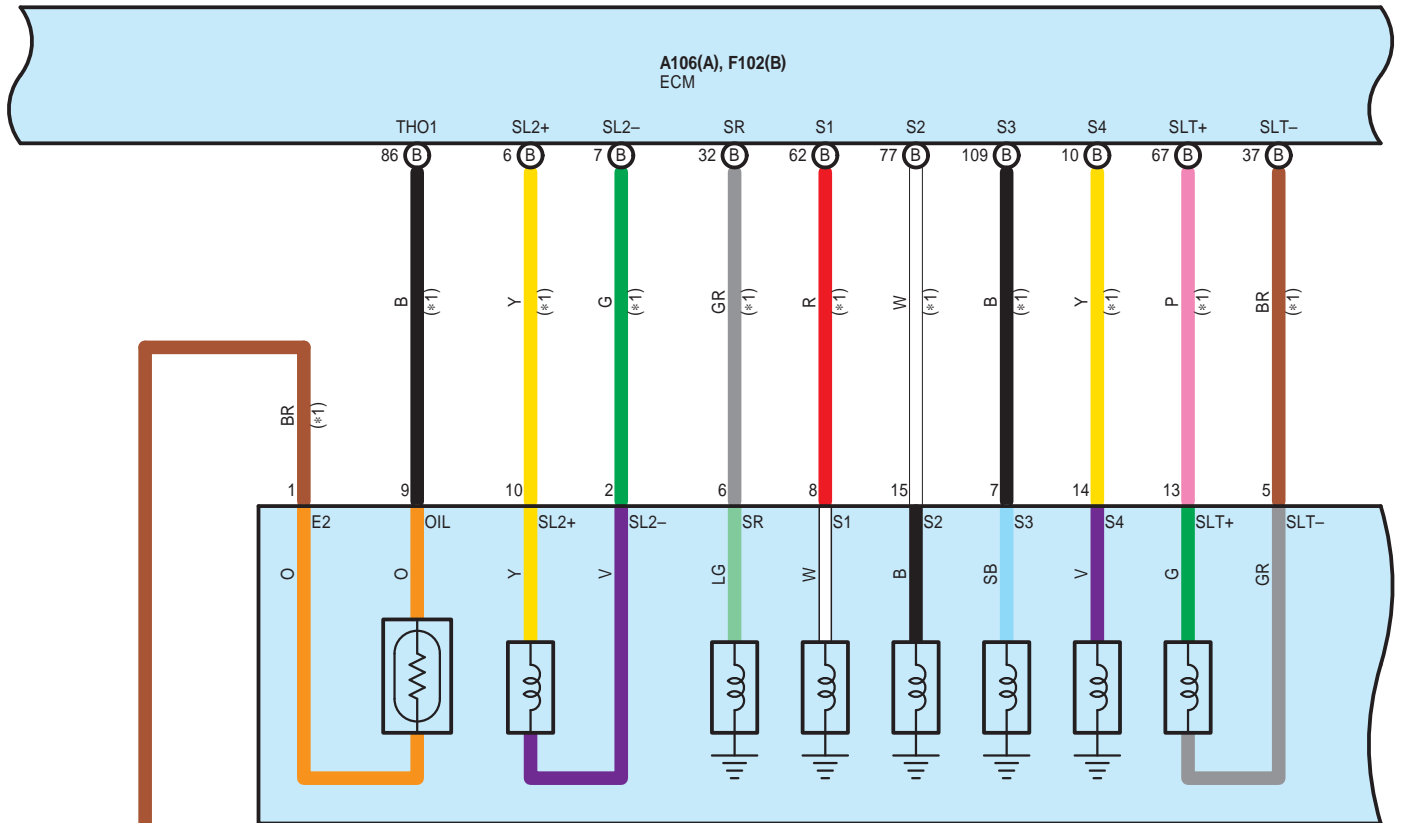

**F56**  
Electronically Controlled Transmission Solenoid  
(Transmission Wire)

\* 1 : 4WD  
\* 2 : 2WD

BR  
(\*1)

BR  
(\*2)

BR  
(\*2)

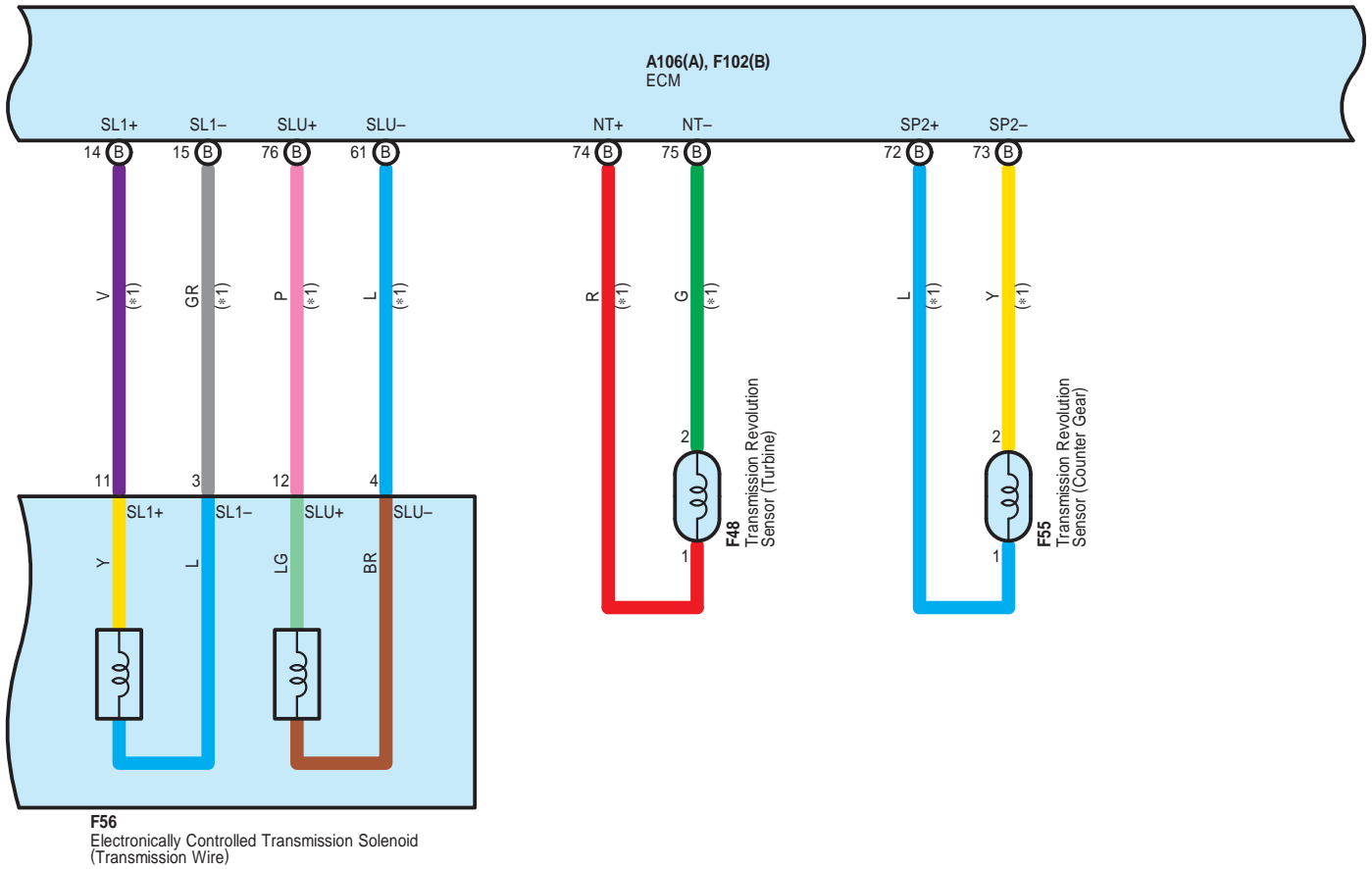



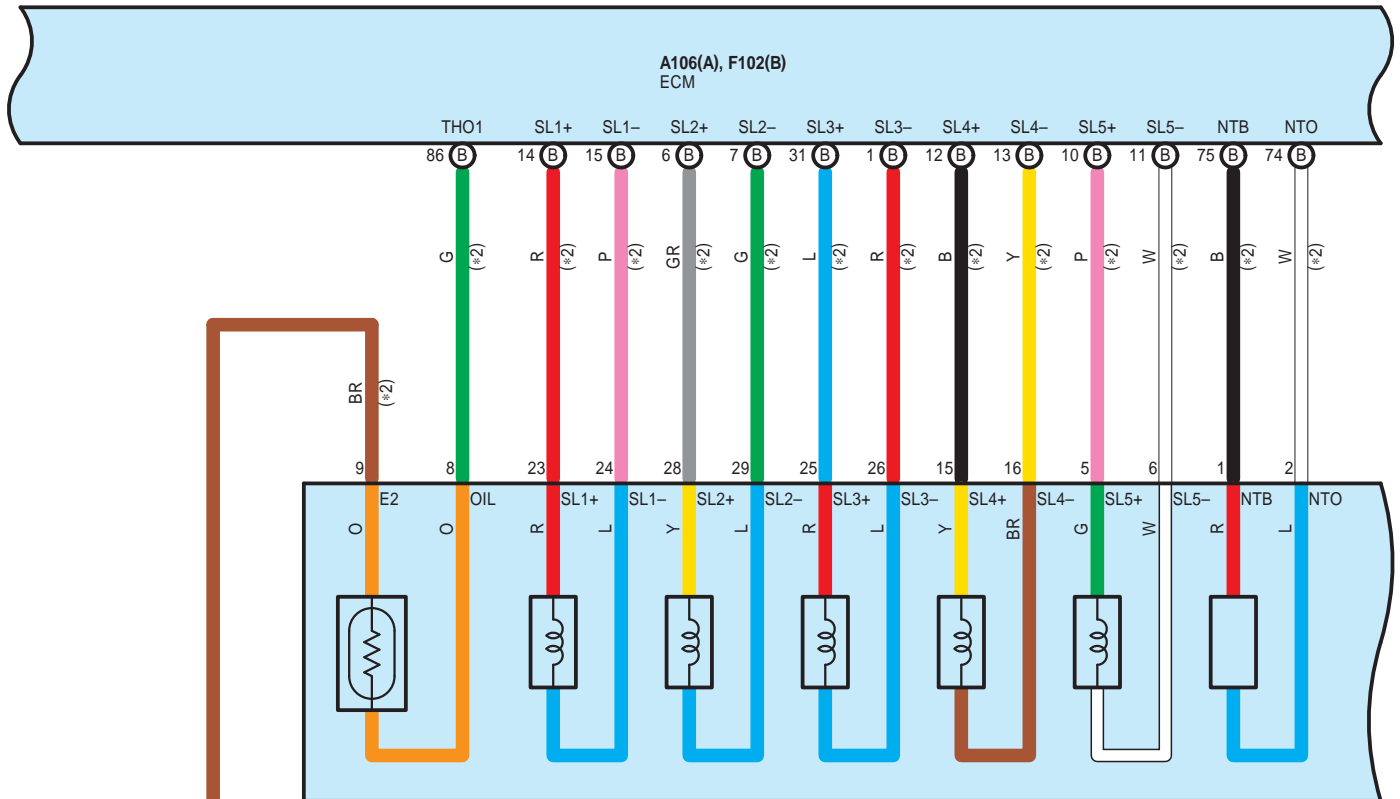

F73  
Electronically Controlled Transmission Solenoid  
(Transmission Wire)

\* 2 : 2WD

BR  
(\*2)

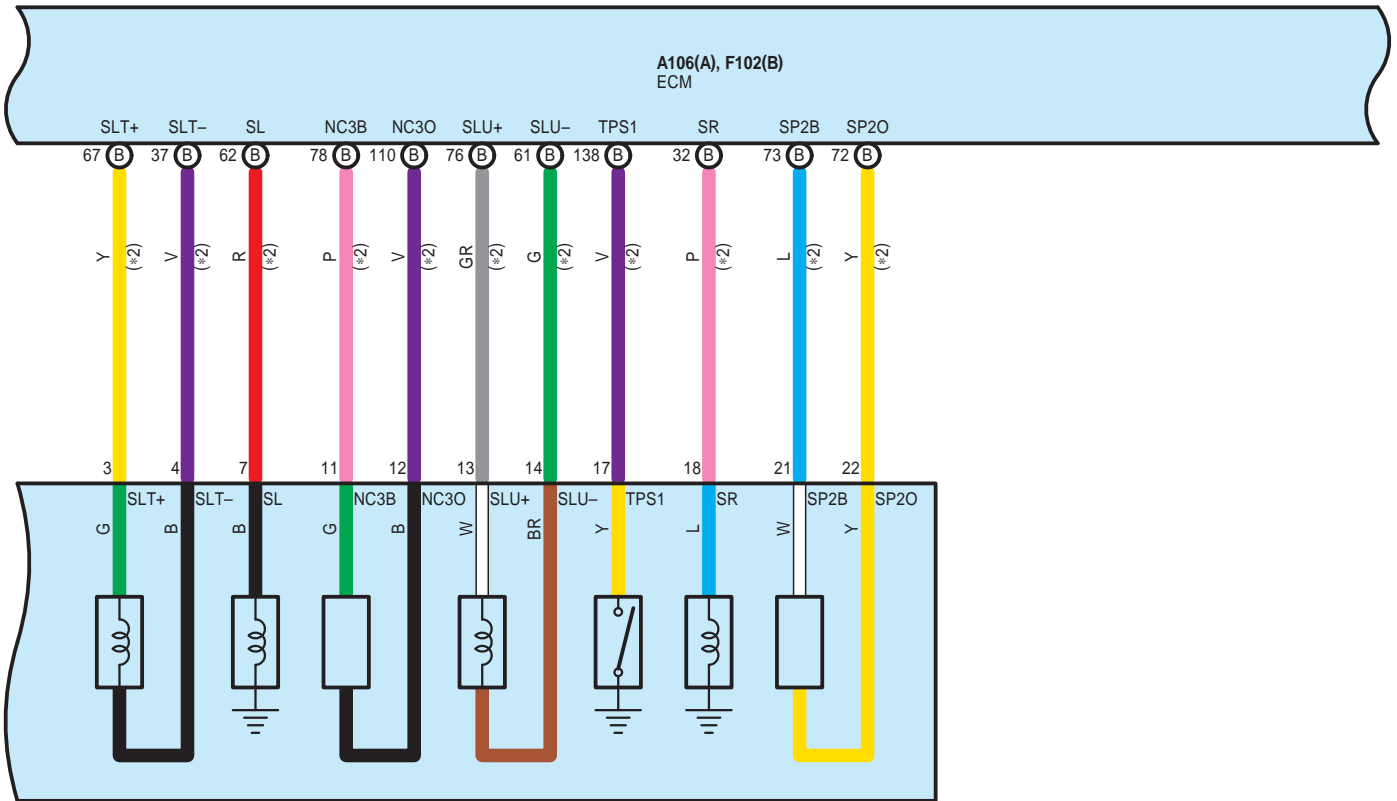

**F73**  
Electronically Controlled Transmission Solenoid  
(Transmission Wire)

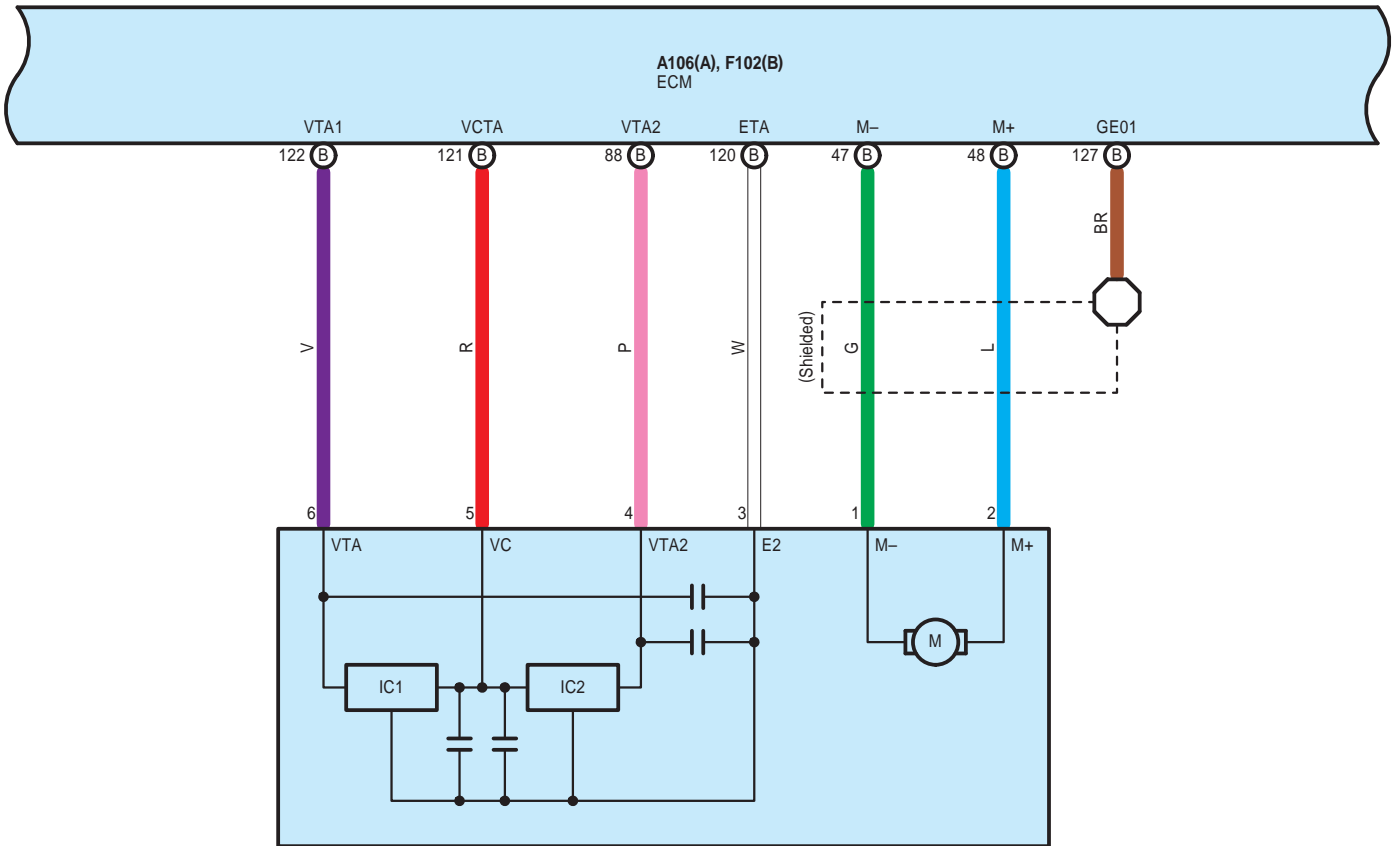

F21  
Throttle Body with Motor Assembly

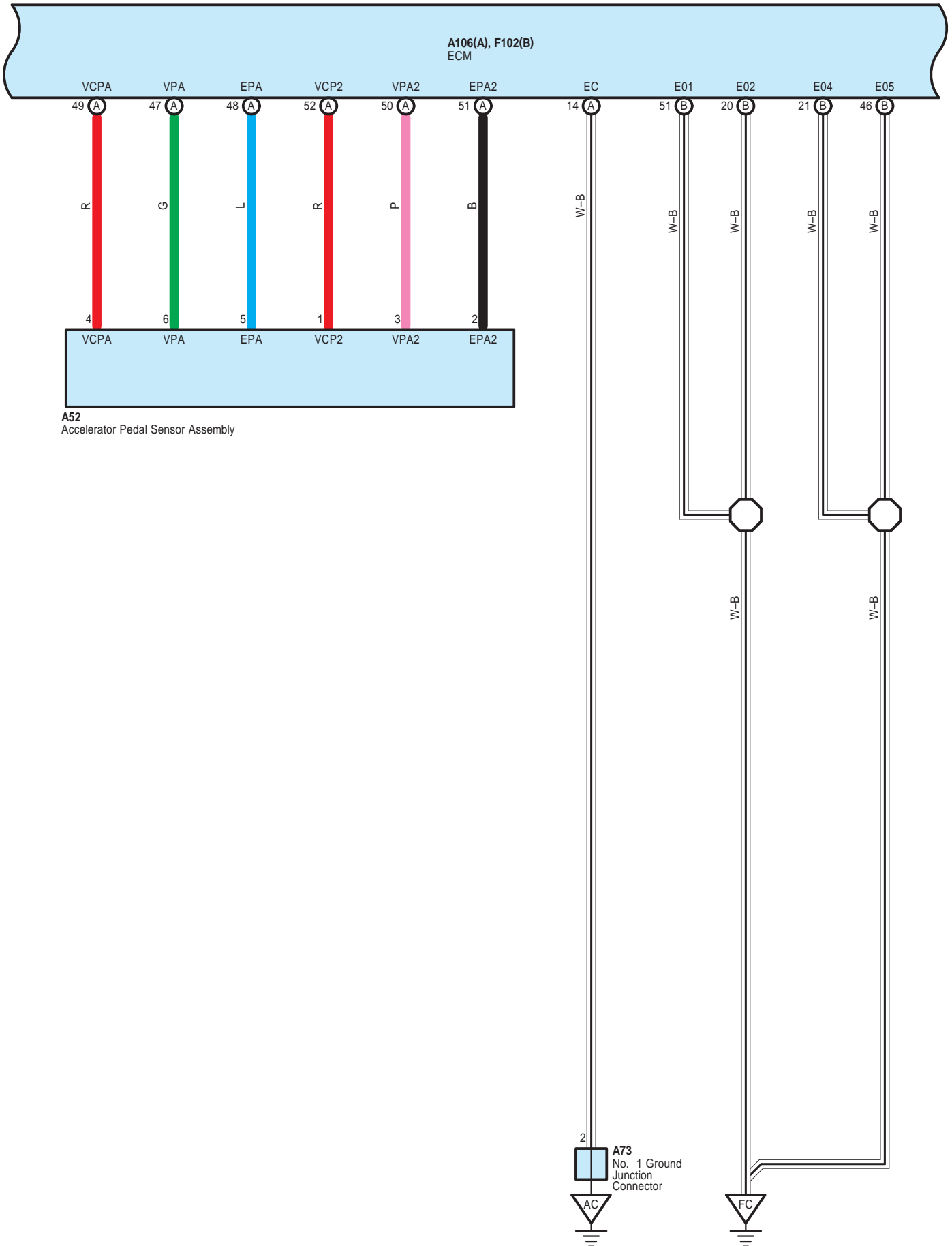

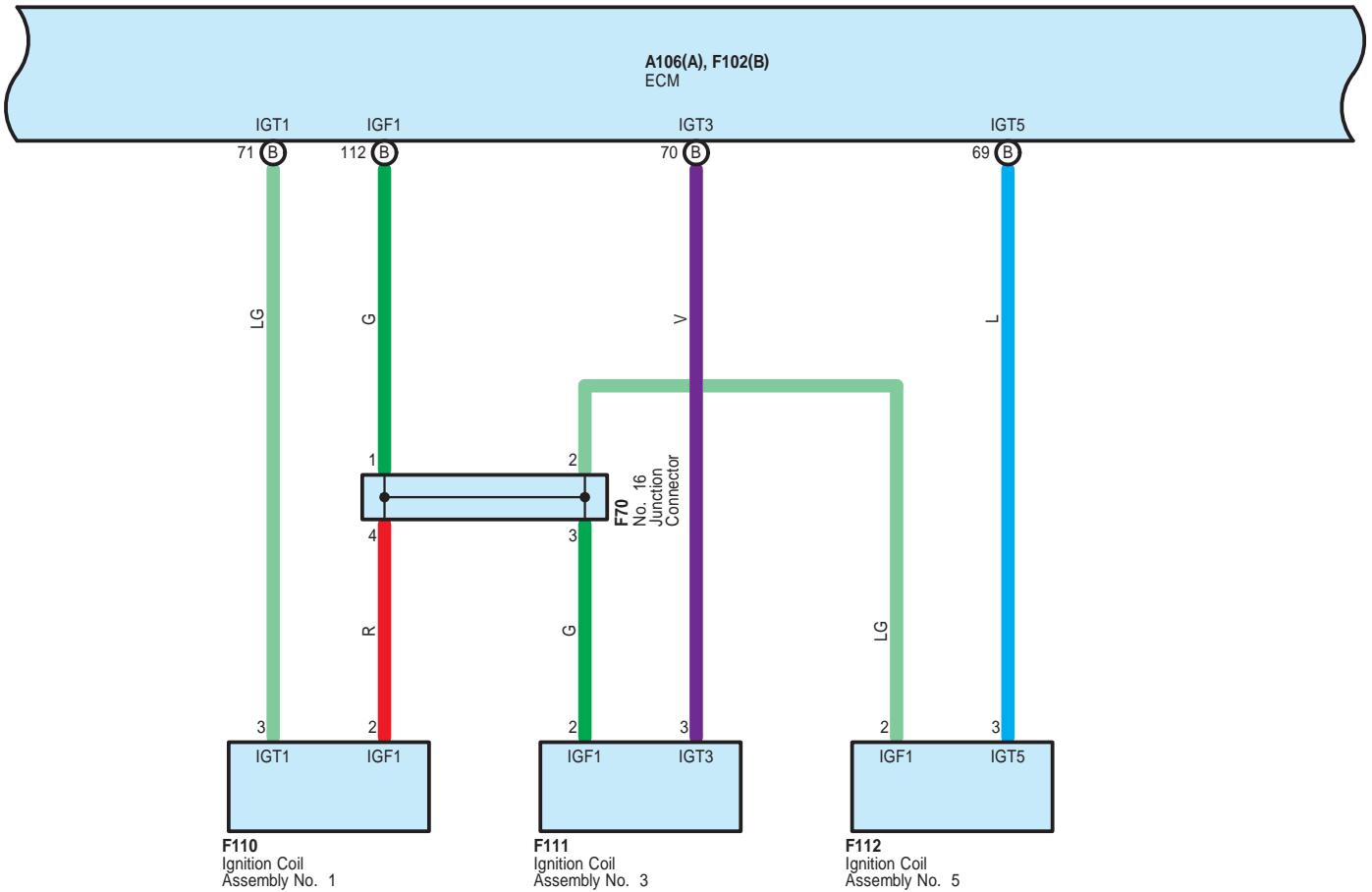

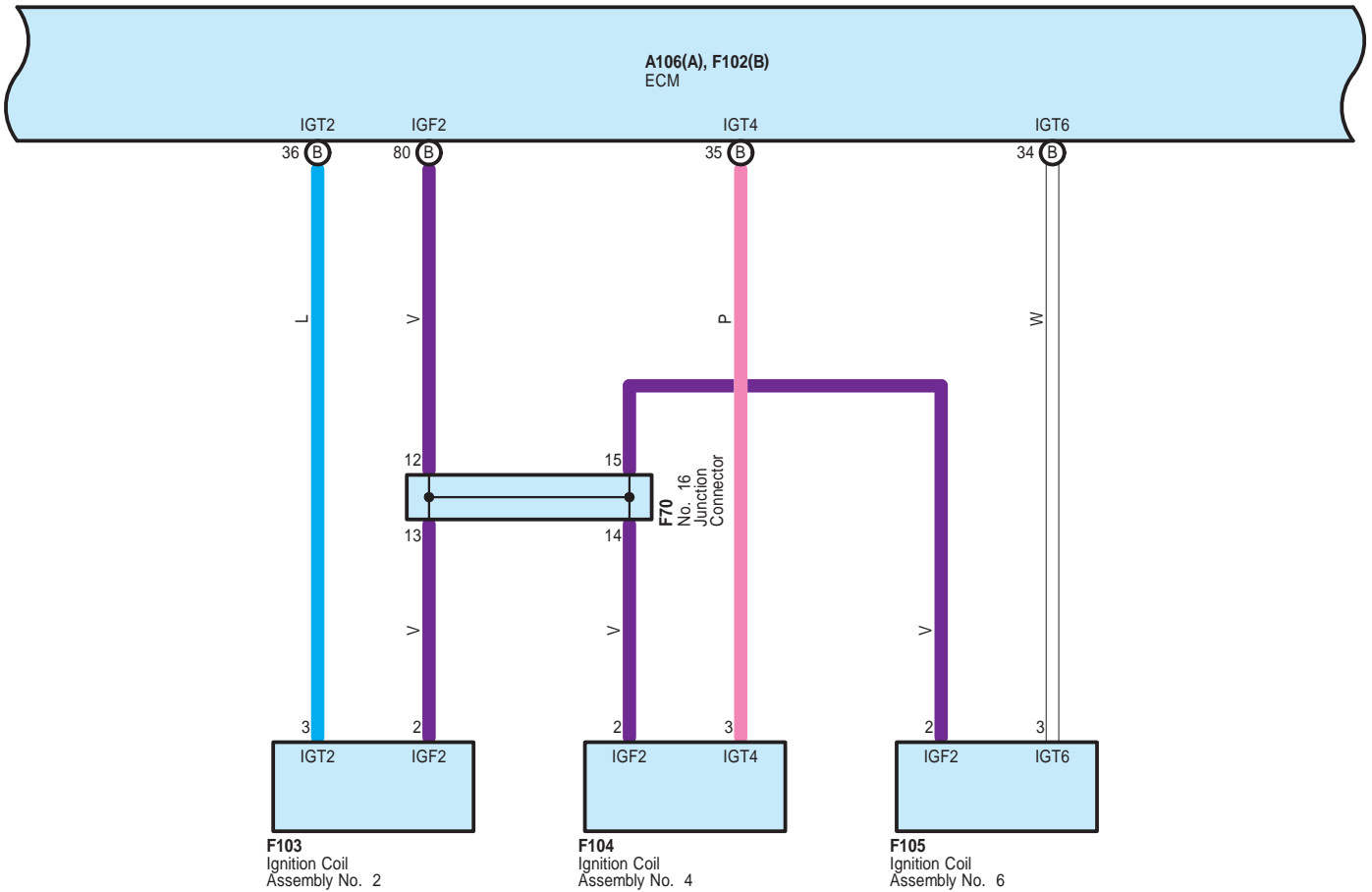

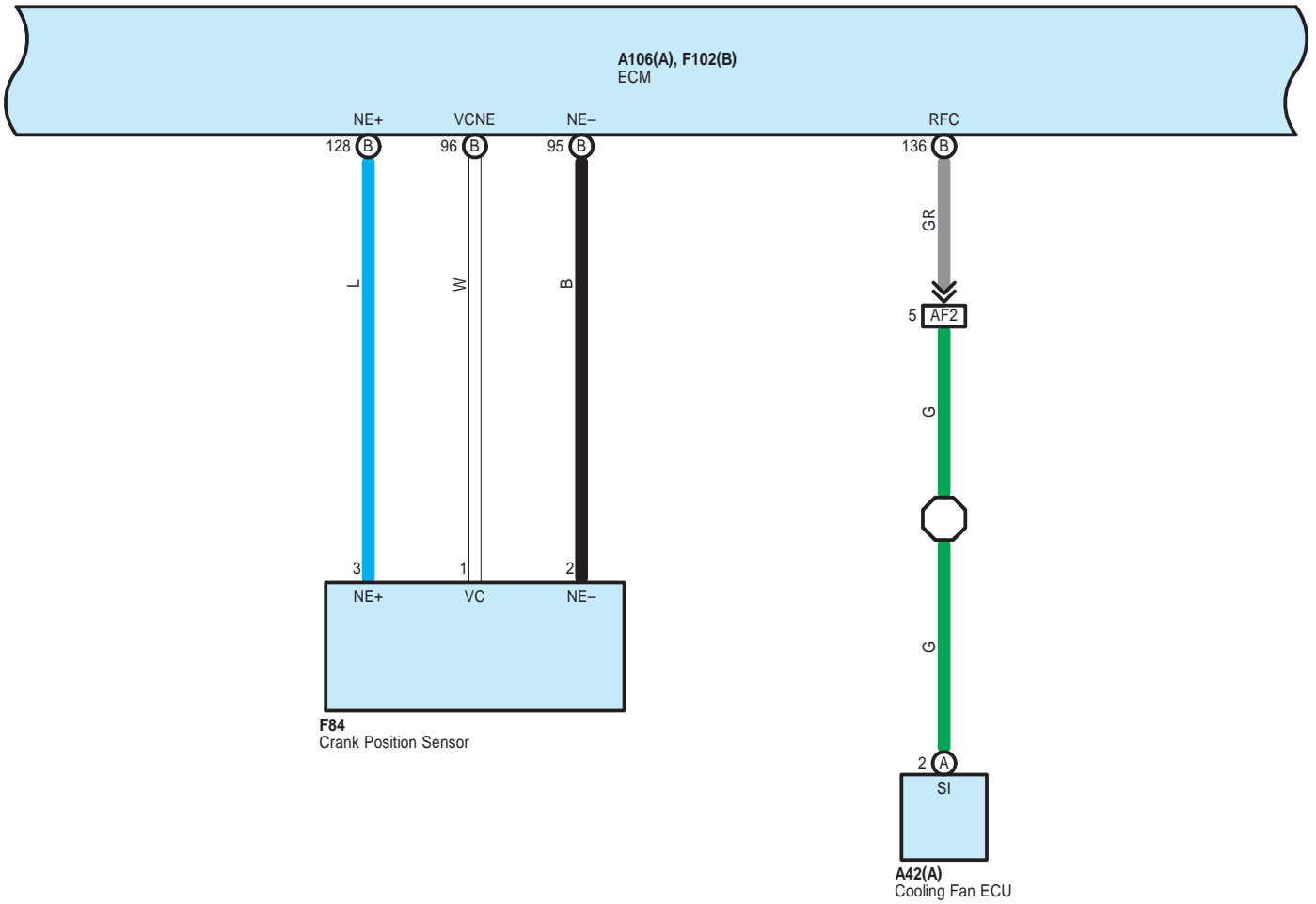

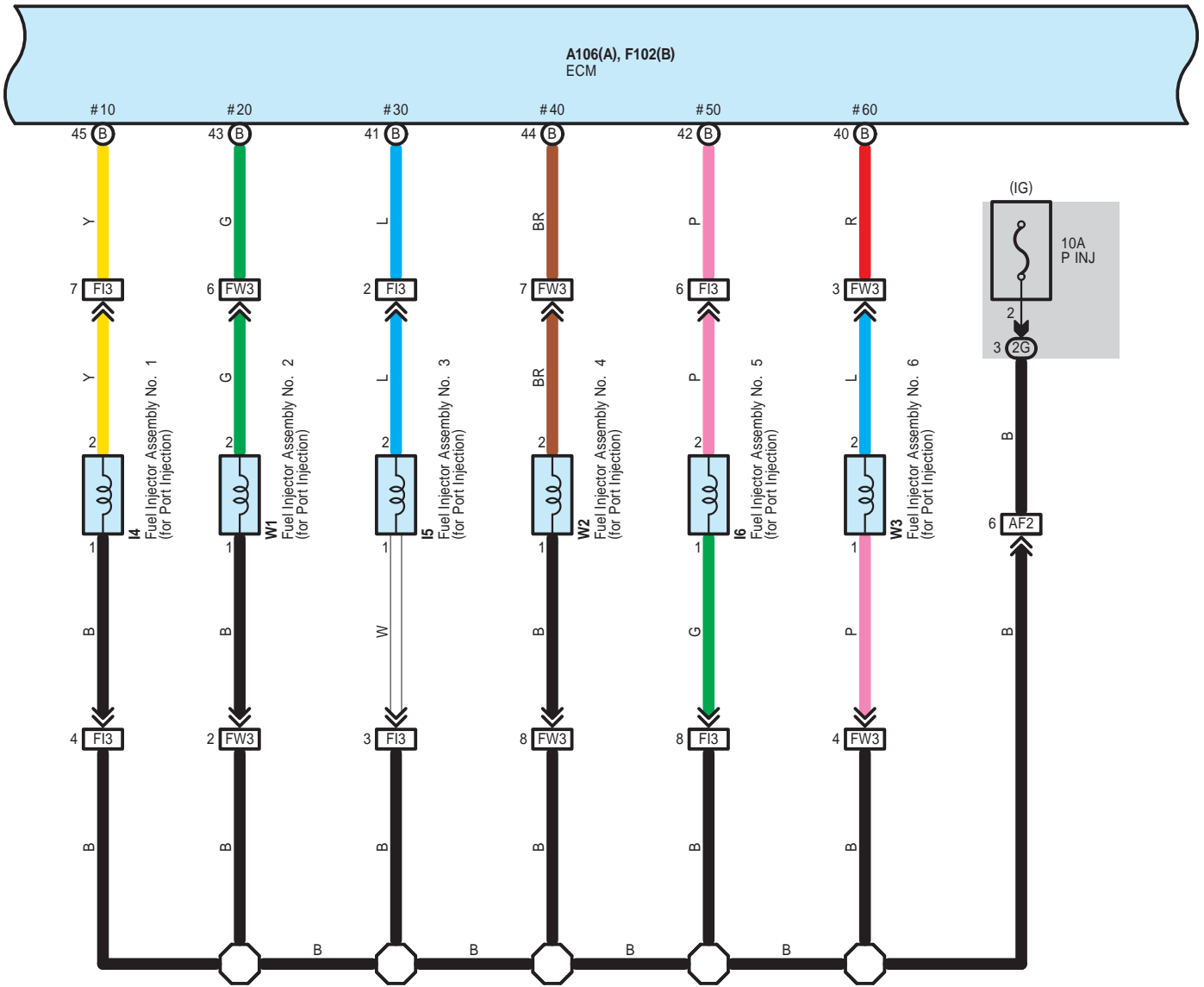



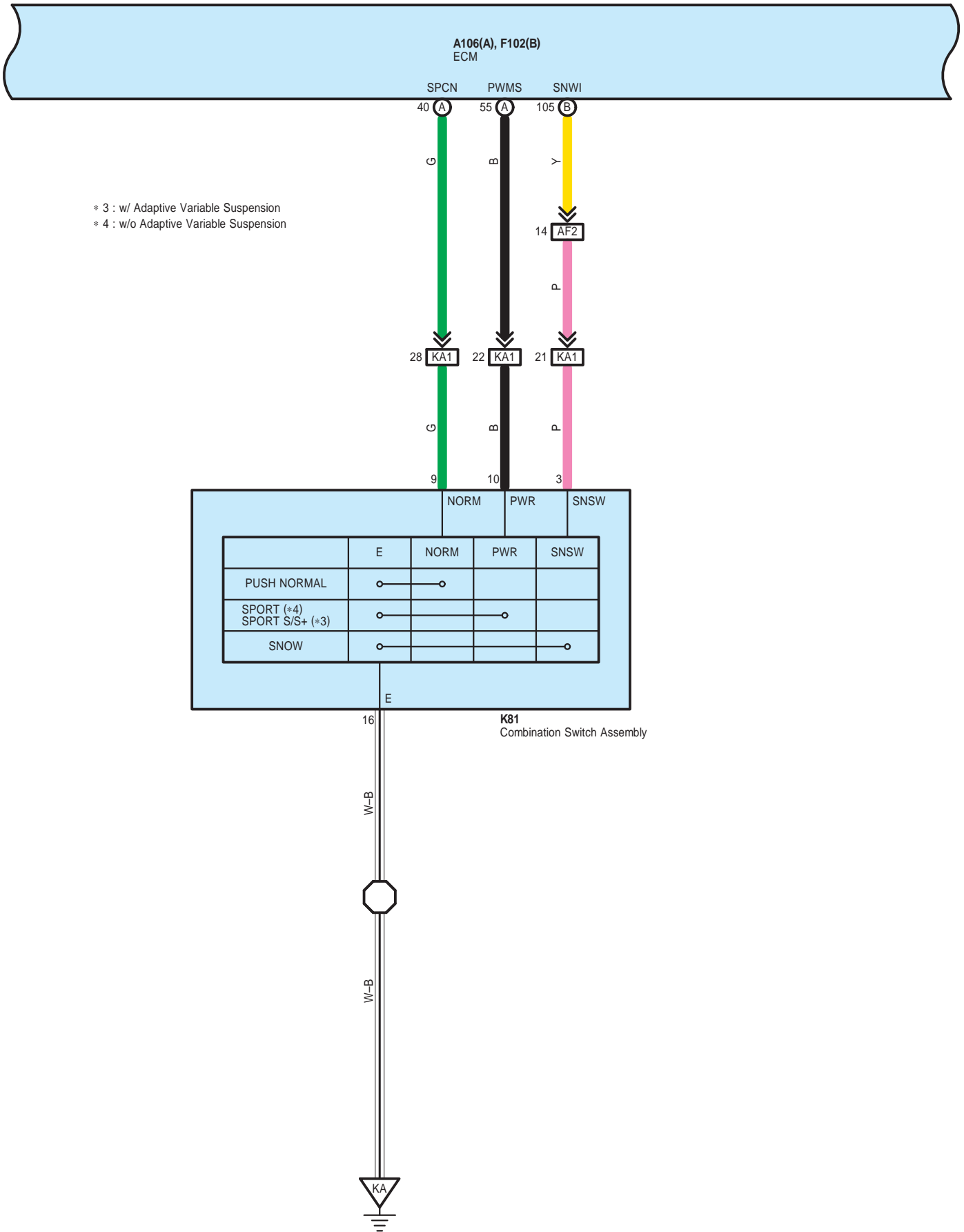

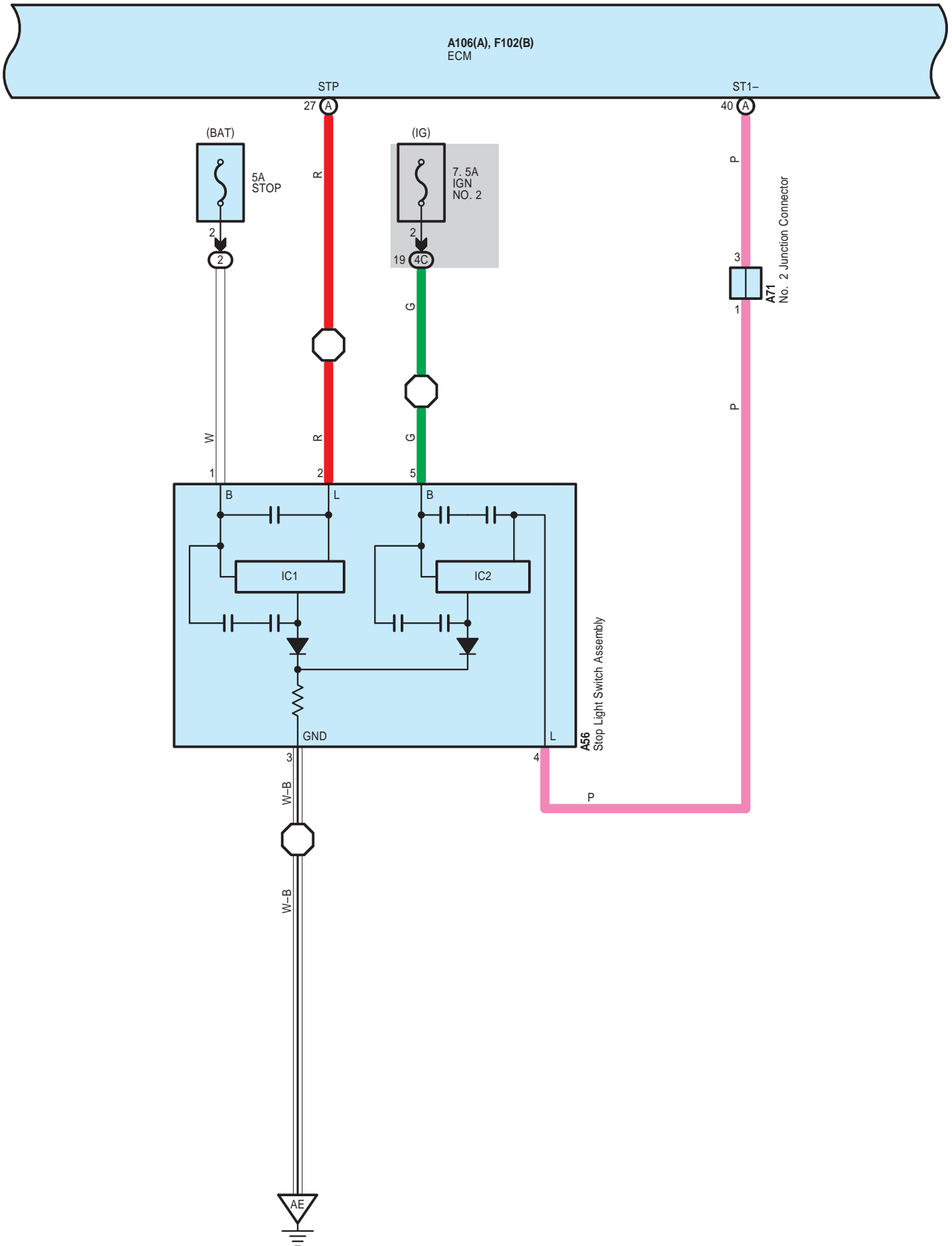

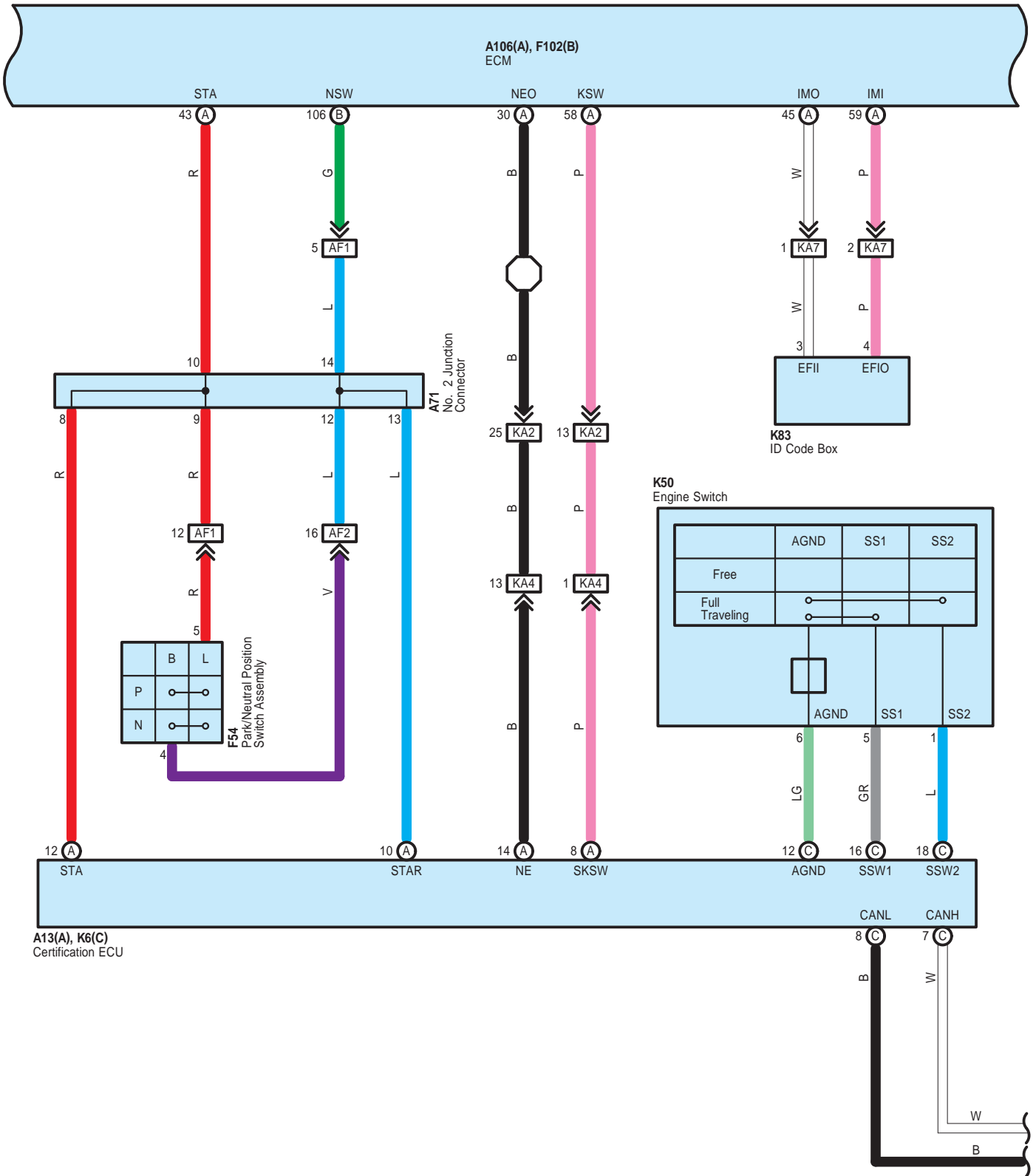

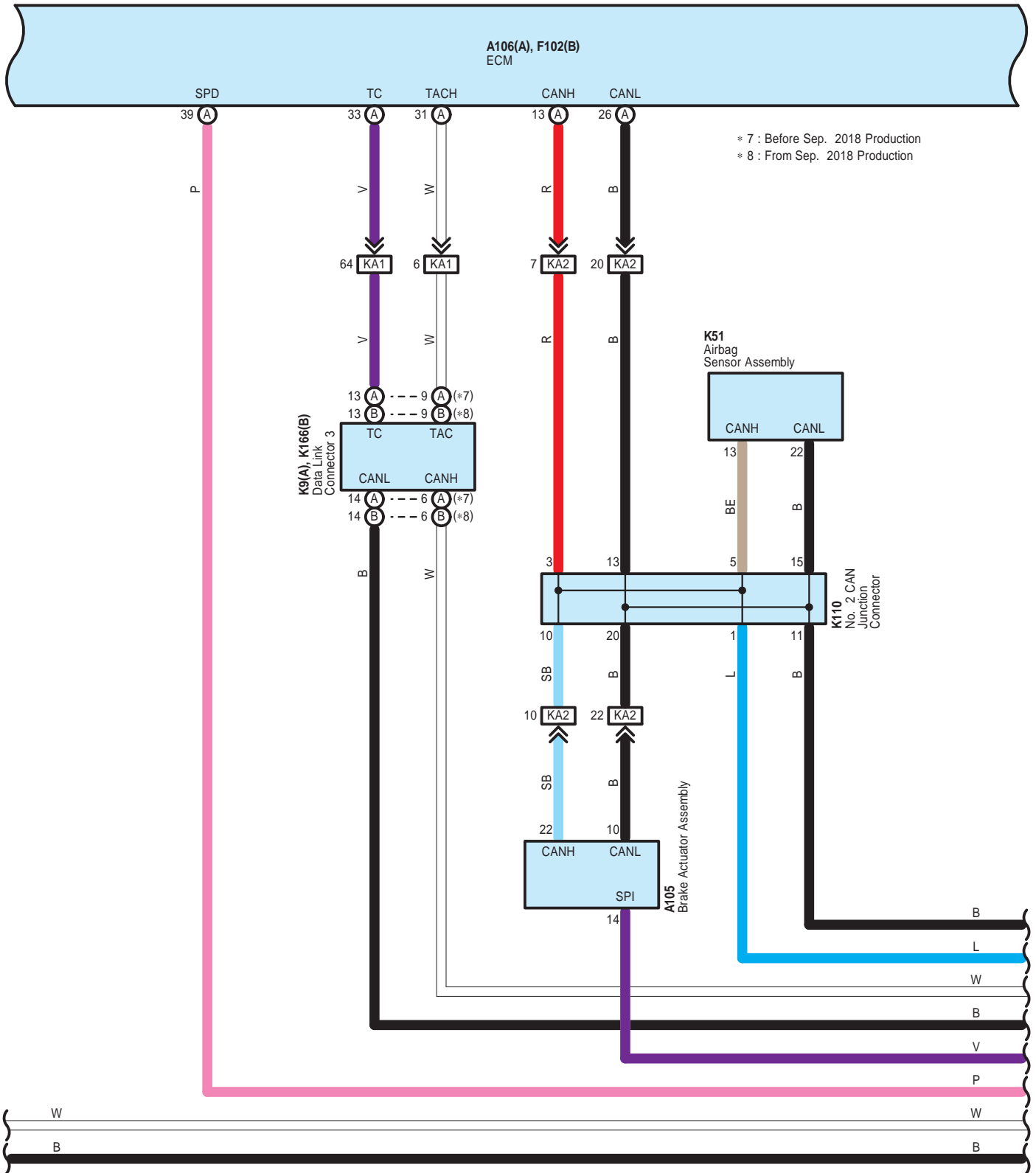

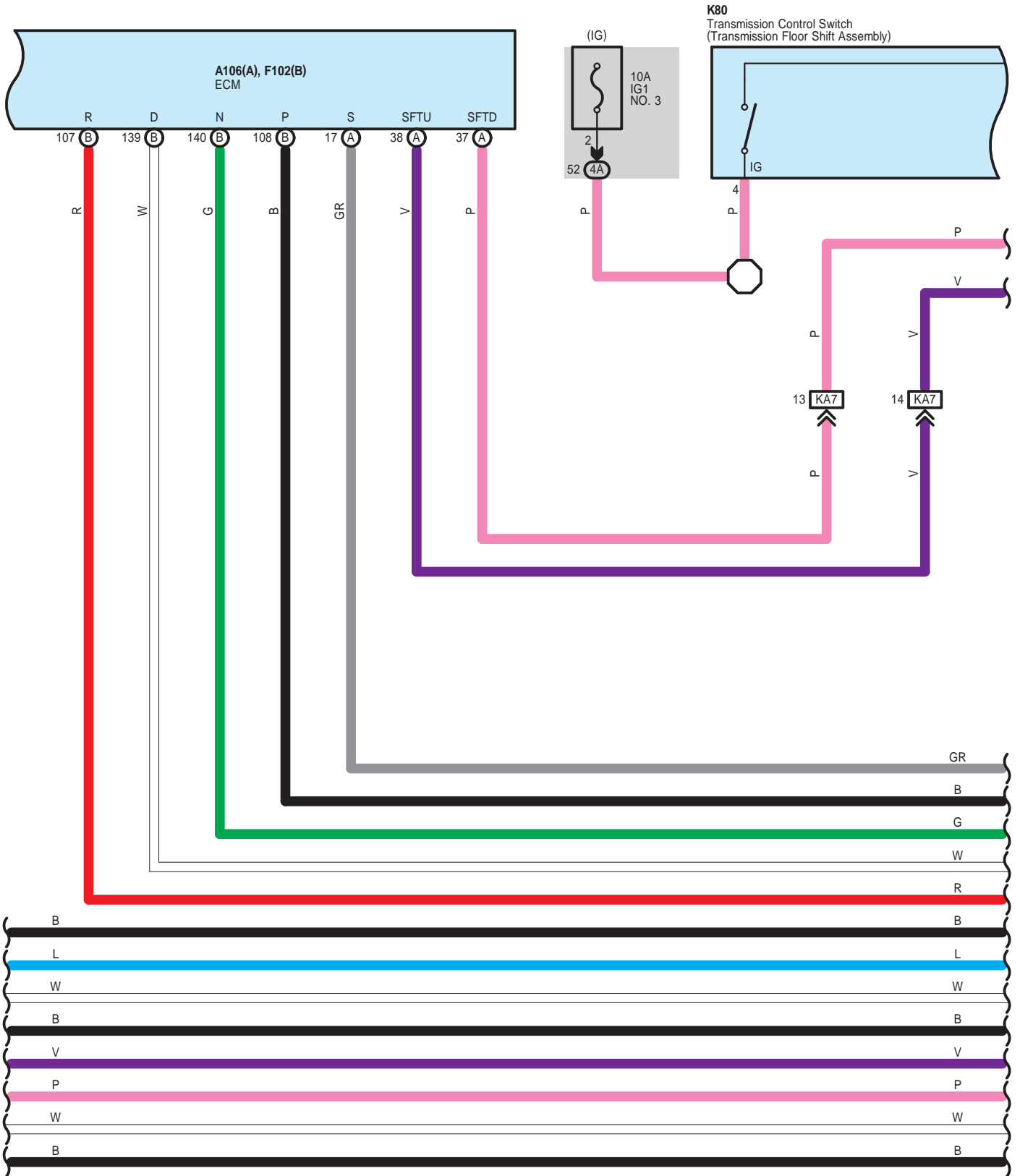

Electronically Controlled Transmission and A/T Indicator (2GR-FKS), Engine Control (2GR-FKS)

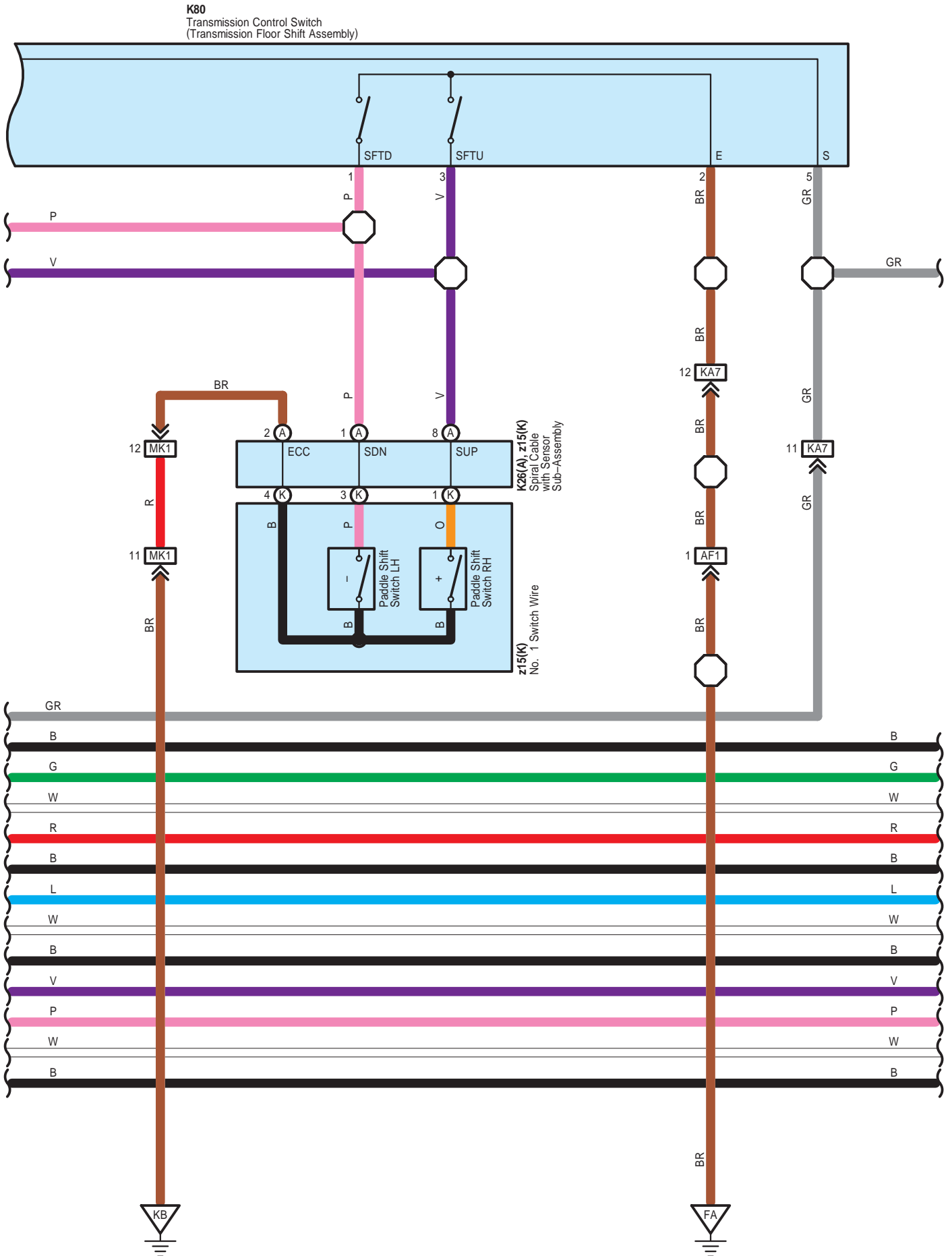

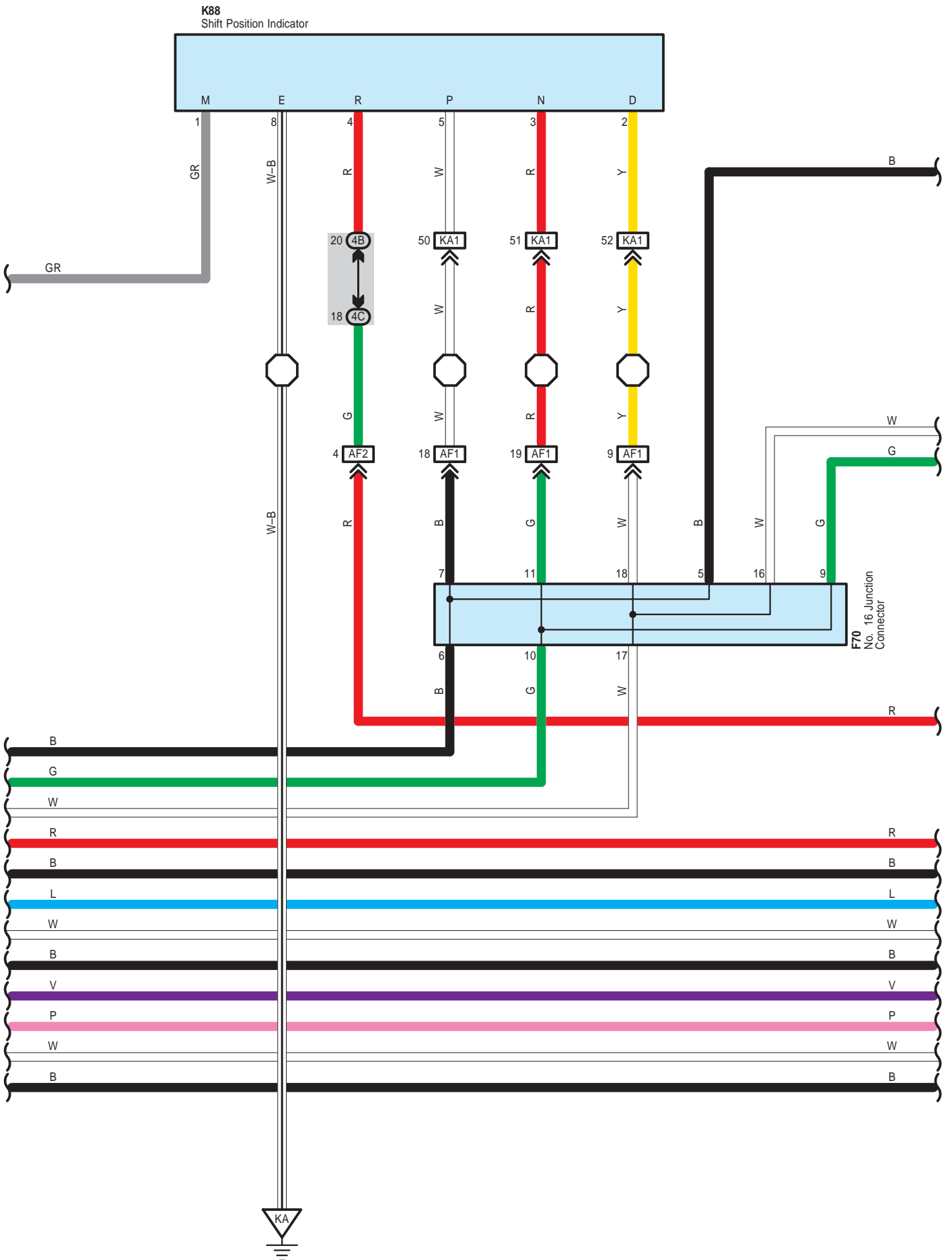

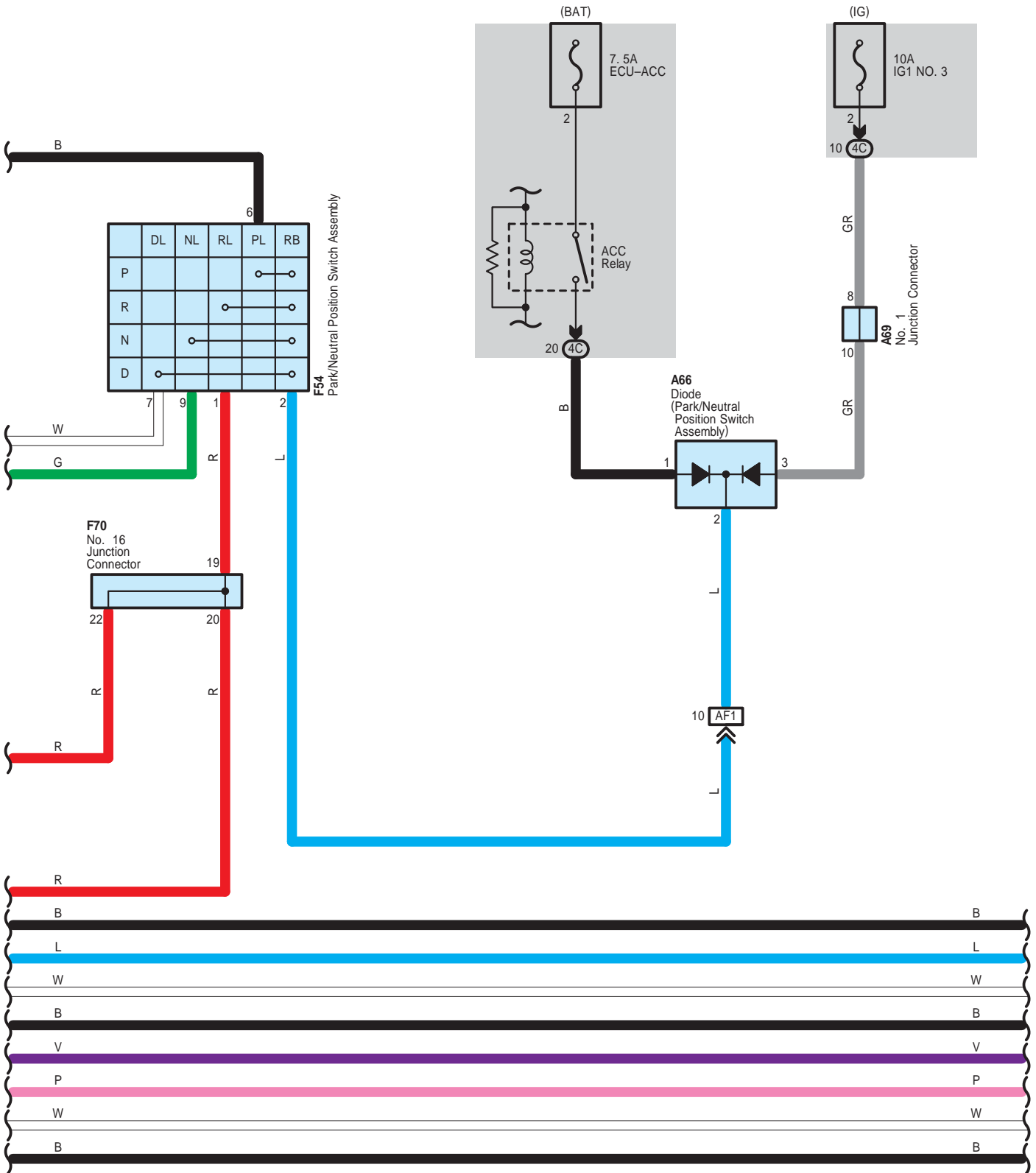



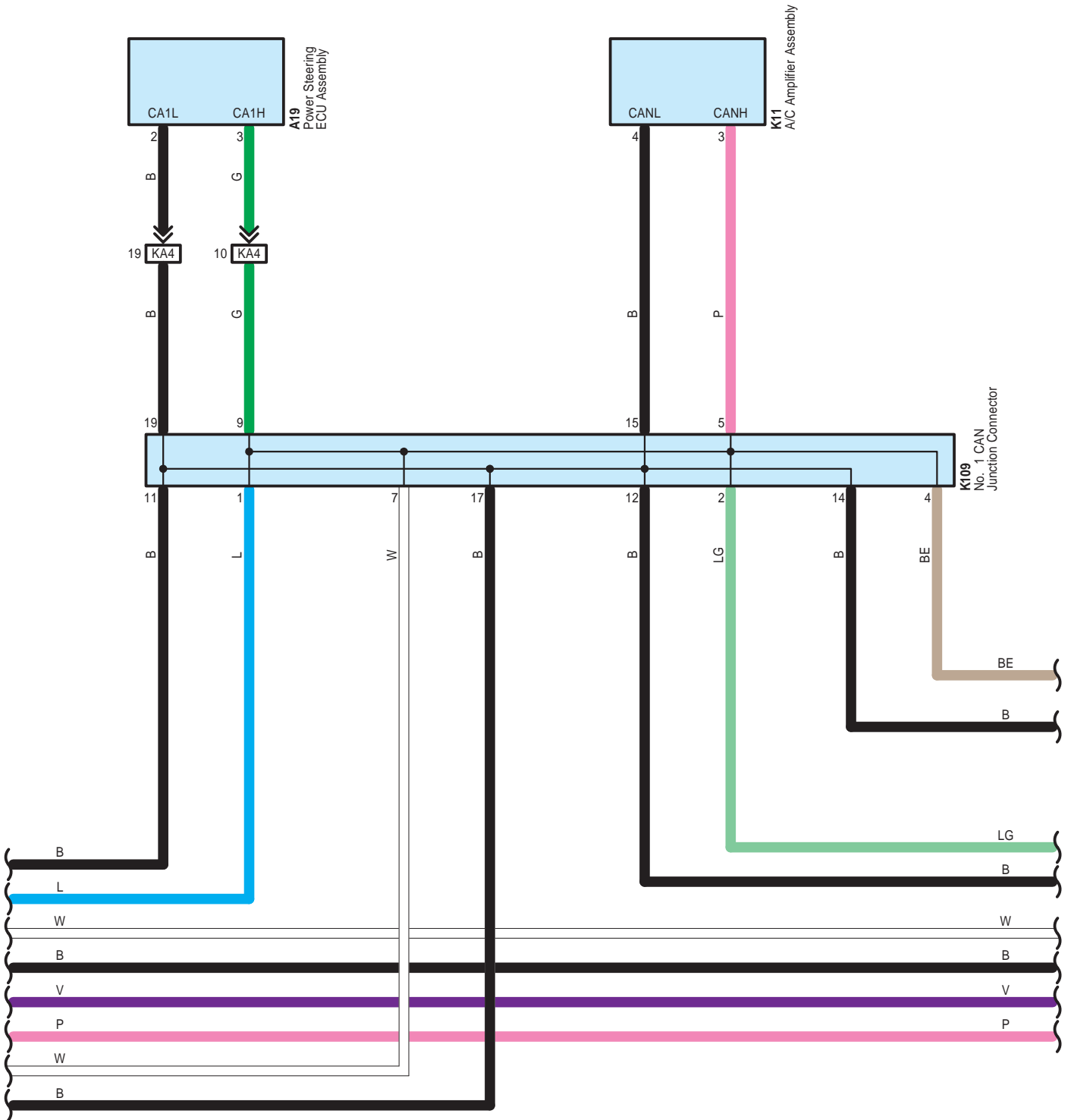

- \* 5 : Before Dec. 2017 Production
- \* 7 : Before Sep. 2018 Production
- \* 8 : From Sep. 2018 Production
- \* 9 : From Dec. 2017 Production until Sep. 2018 Production

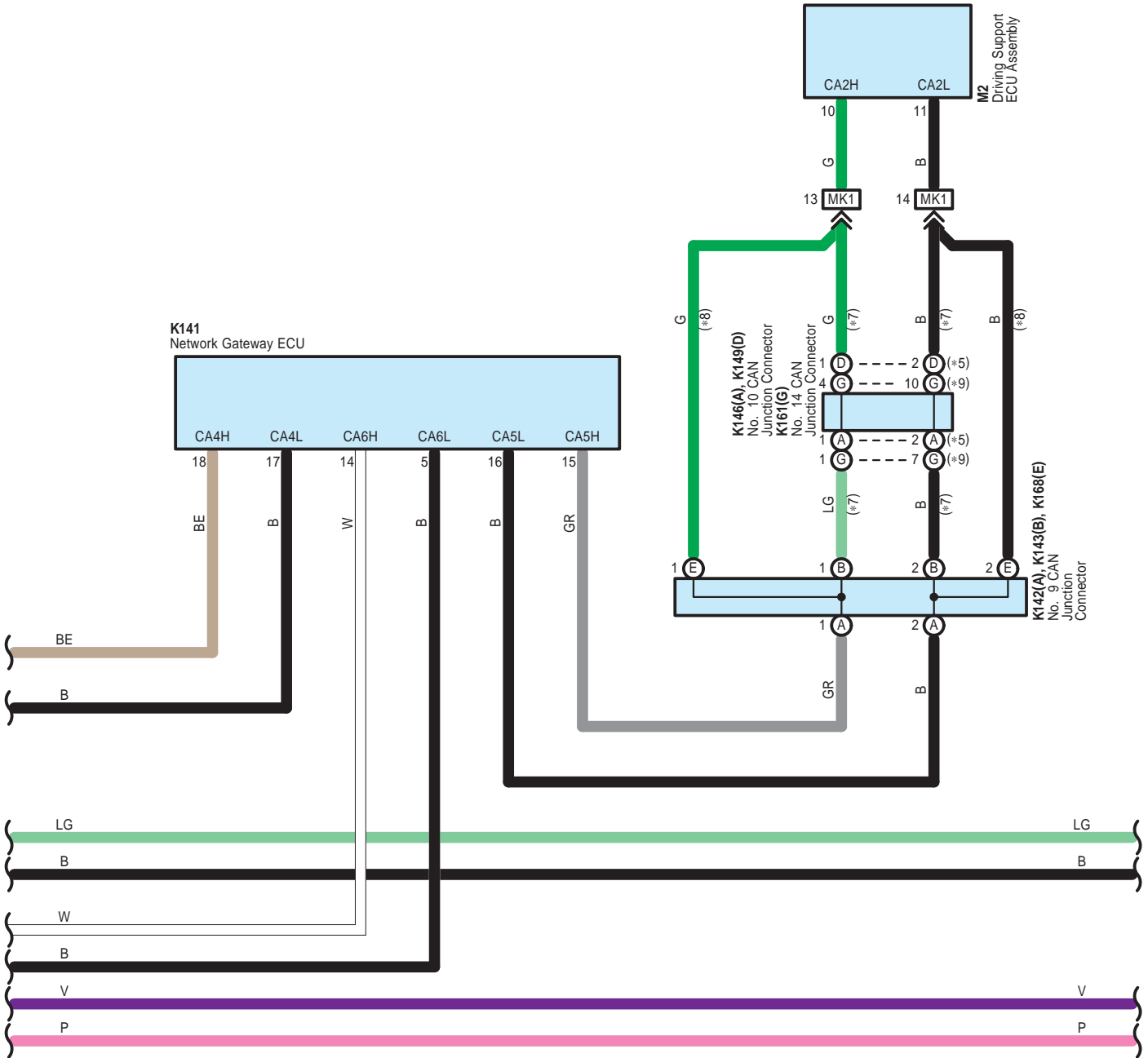

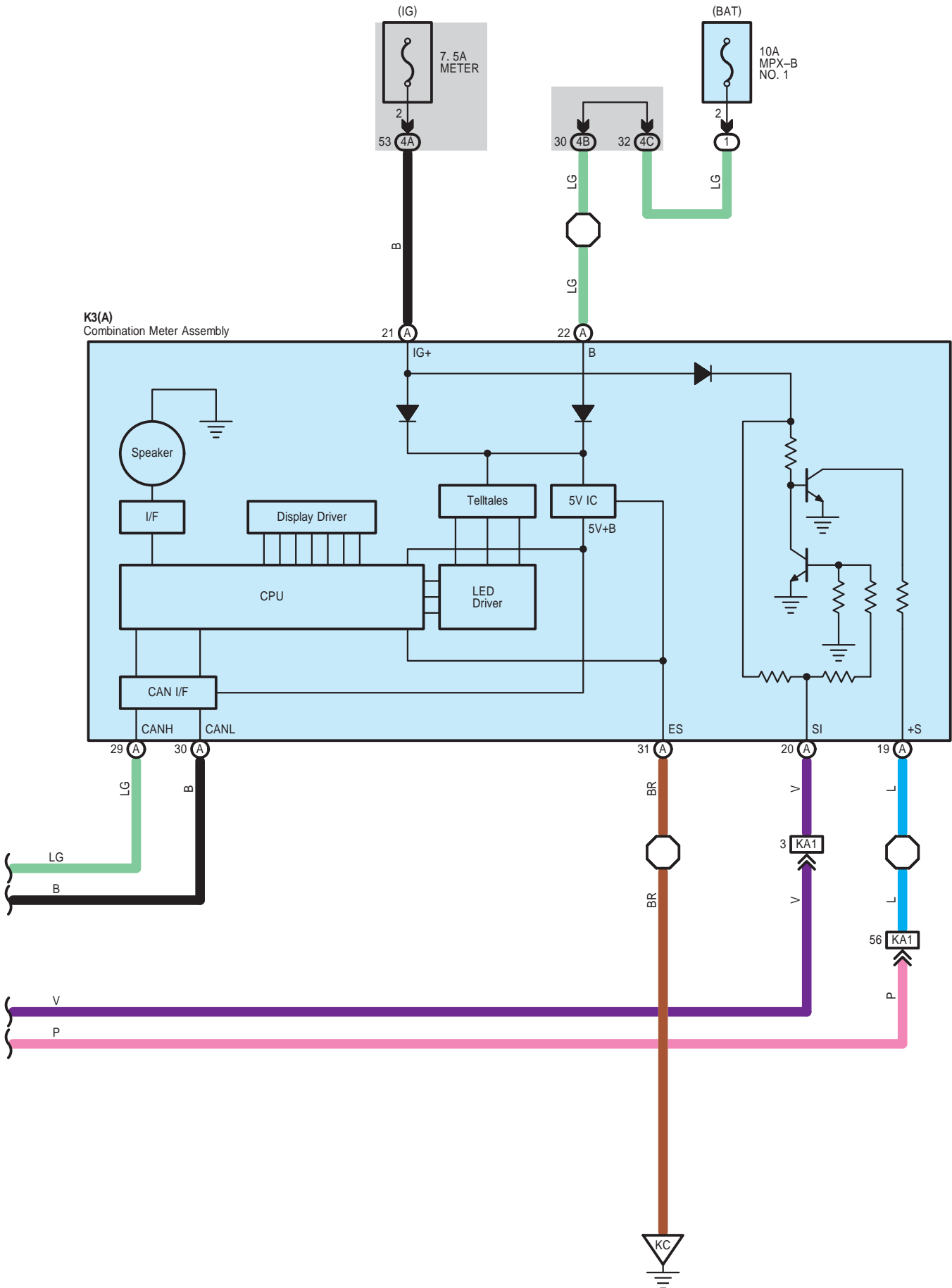

Electronically Controlled Transmission and A/T Indicator (2GR-FKS), Engine Control (2GR-FKS)

A13  
White

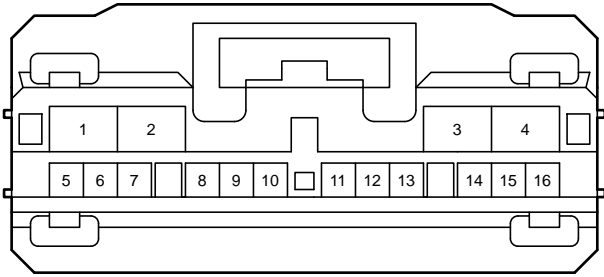

90980-12763

A19  
Black

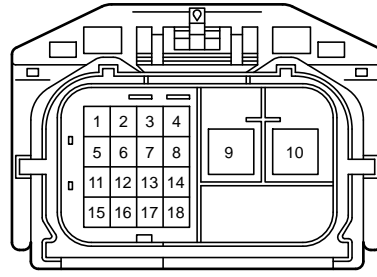

90980-12573

A42  
Black

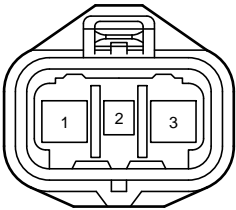

90980-12058

A52  
Black

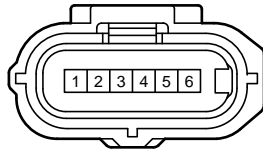

90980-12831

A56  
White

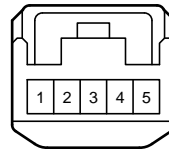

90980-12366

A57  
Black

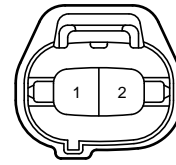

90980-11156

A66  
Gray

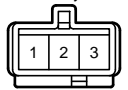

90980-11071

A69  
White

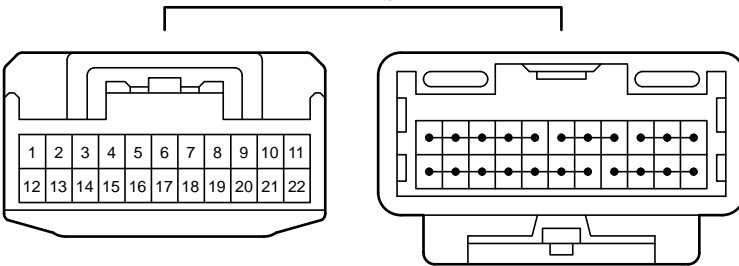

90980-12372

A71  
White

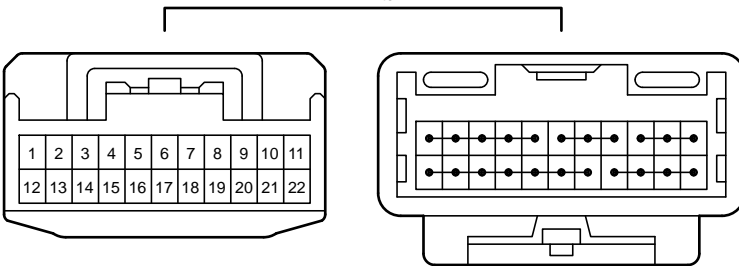

90980-12372

A73  
White

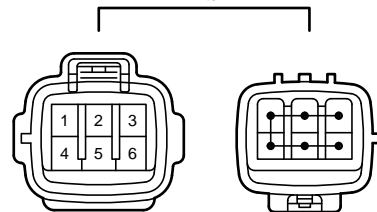

90980-11194

**Electronically Controlled Transmission and A/T Indicator (2GR-FKS), Engine Control (2GR-FKS)**

A105  
Black

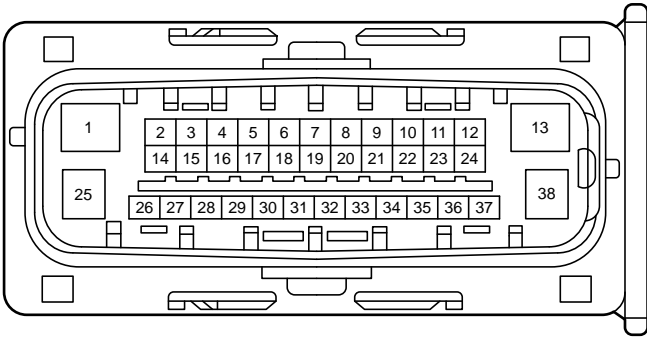

90980-12B01

A106  
Black

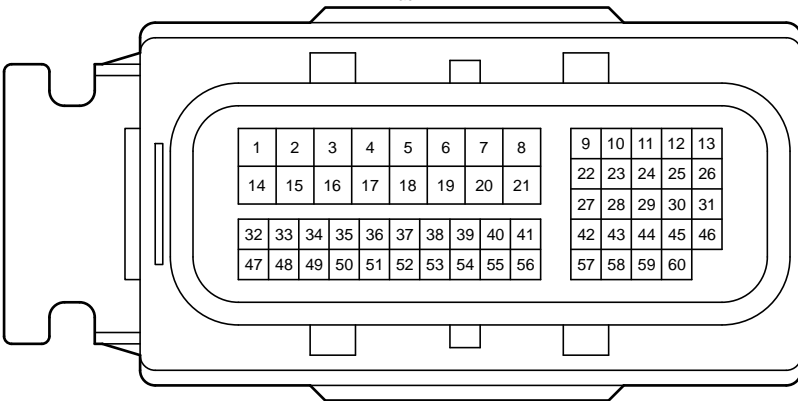

90980-12931

F9  
Black

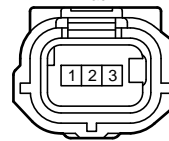

90980-12353

F14  
Black

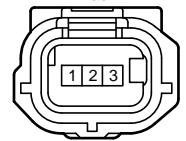

90980-12353

F21  
Black

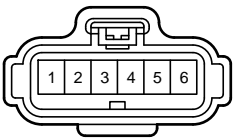

90980-11858

F26  
Black

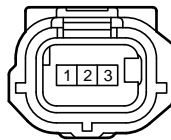

90980-12353

F33  
Black

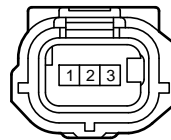

90980-12353

F40  
Black

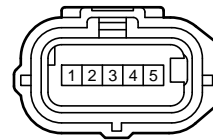

90980-12292

F48  
Black

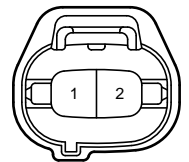

90980-11156

F54  
Gray

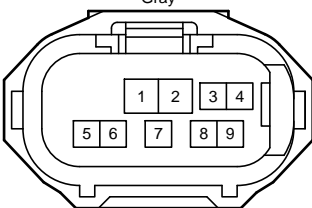

90980-12A23  
(2GR-FKS, 2GR-FSE, 4GR-FSE)

F54  
Black

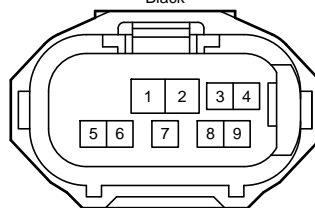

90980-12A23  
(8AR-FTS)

F55  
Black

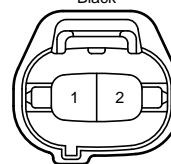

90980-11156

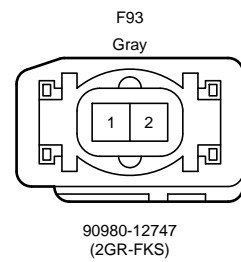
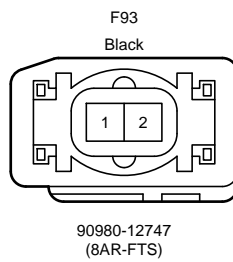
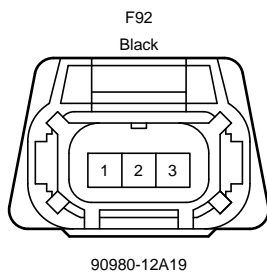
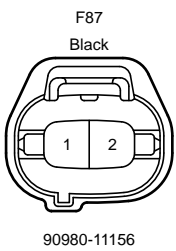
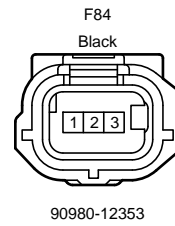
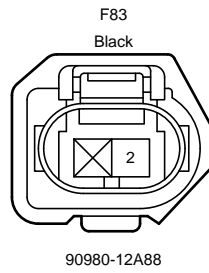
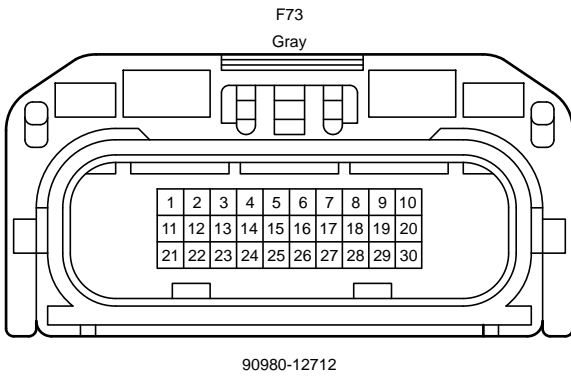
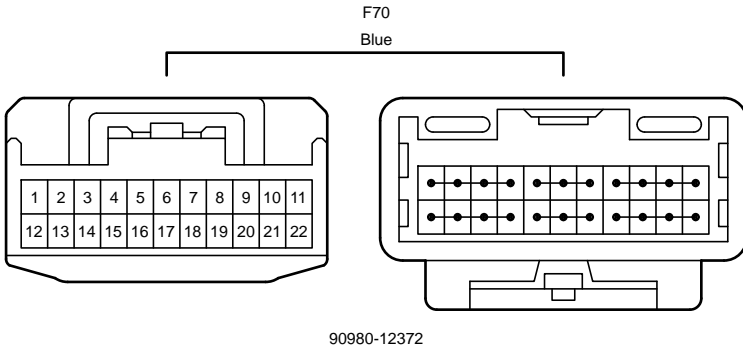
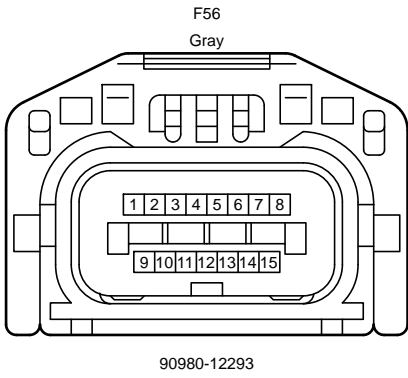

Electronically Controlled Transmission and A/T Indicator (2GR-FKS), Engine Control (2GR-FKS)

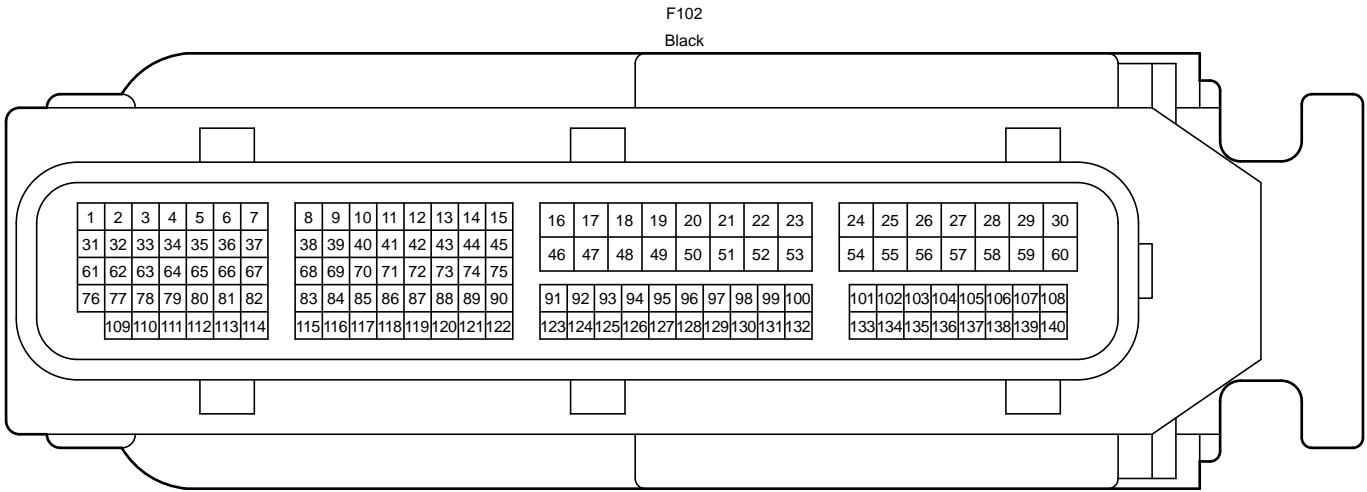

90980-12836

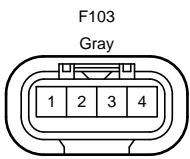

90980-12A29

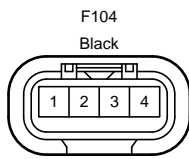

90980-12A29

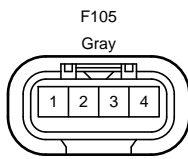

90980-12A29

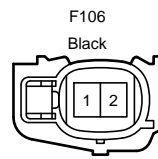

90980-11875

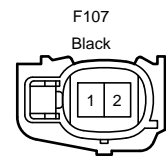

90980-11875

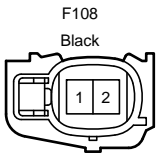

90980-11875

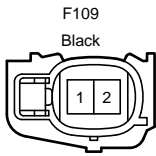

90980-11875

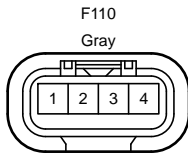

90980-12A29

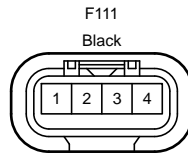

90980-12A29

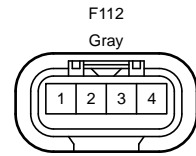

90980-12A29

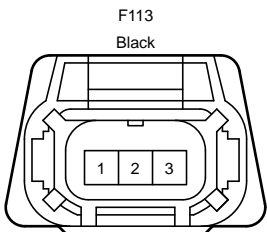

90980-12A19

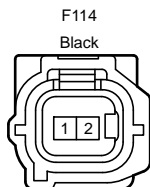

90980-12416

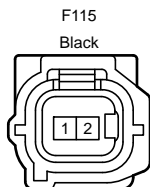

90980-12572

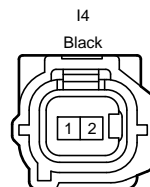

90980-12416

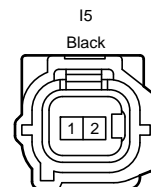

90980-12416

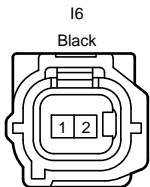

90980-12416

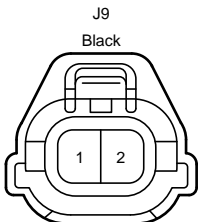

90980-12940

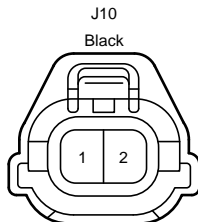

90980-12940

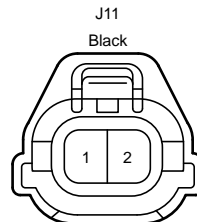

90980-12940

Electronically Controlled Transmission and A/T Indicator (2GR-FKS), Engine Control (2GR-FKS)

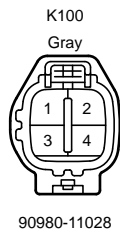
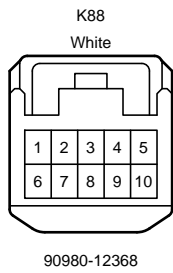
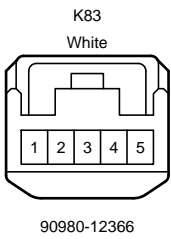
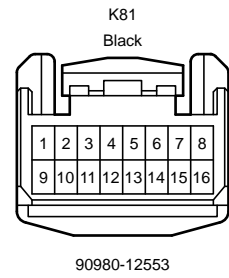
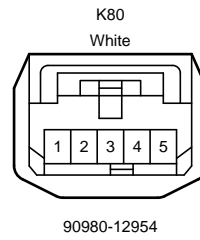
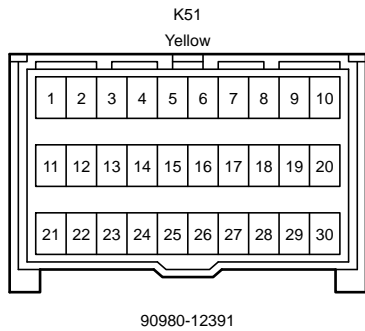
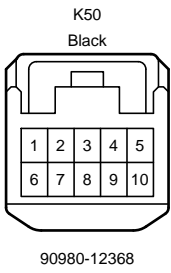
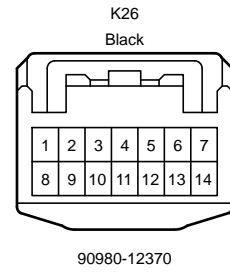
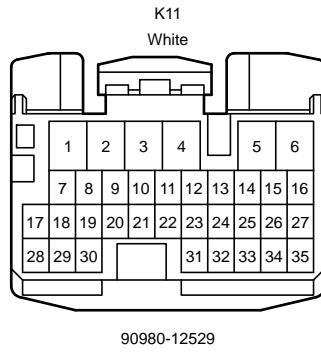
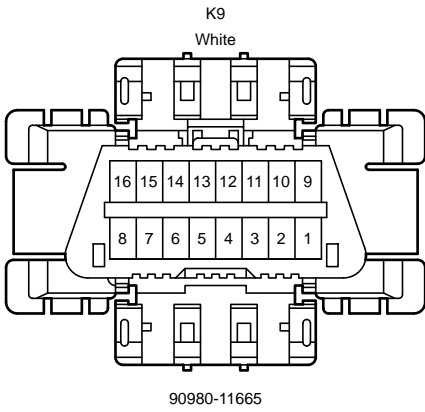
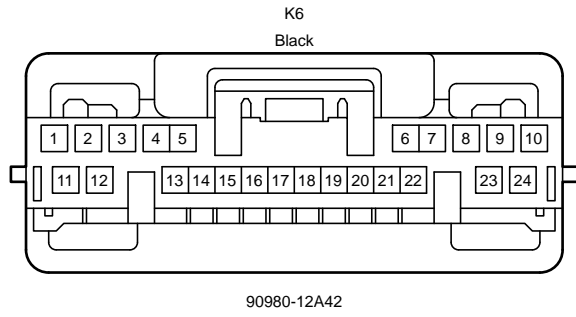
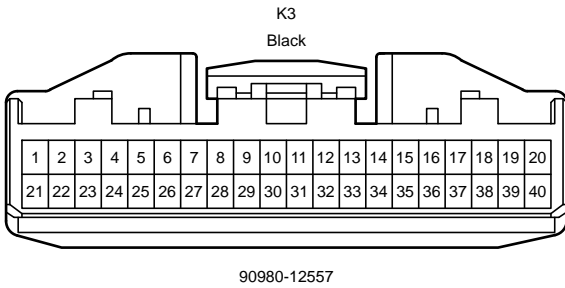



K109  
White

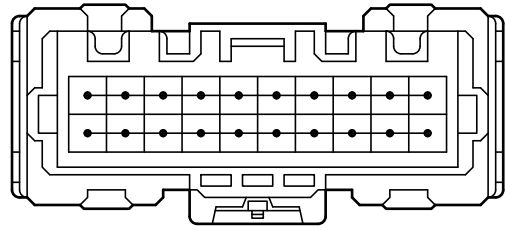
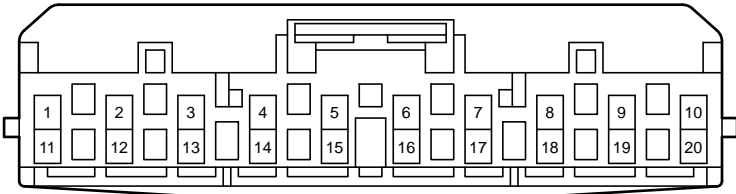

90980-12A58

K110  
White

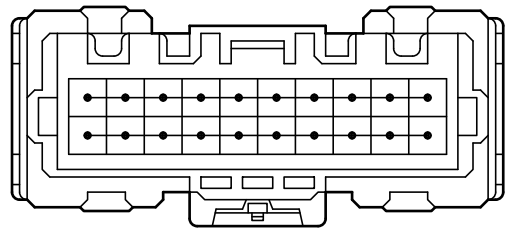
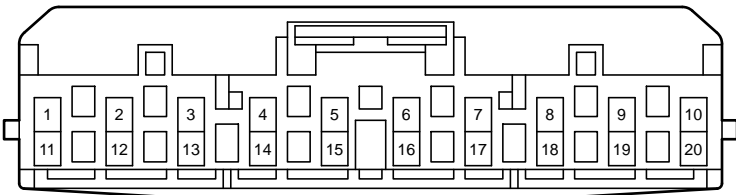

90980-12A58

K141  
Black

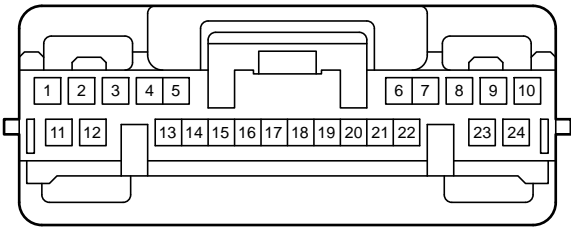

90980-12912

K142  
White

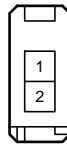

90980-12827

K143  
White

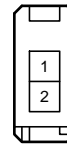

90980-12827

K146  
White

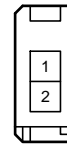

90980-12827

K149  
White

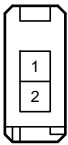

90980-12827

K161  
White

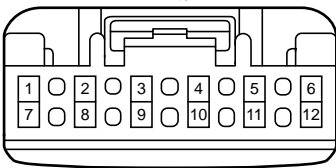

90980-12C68

K166  
White

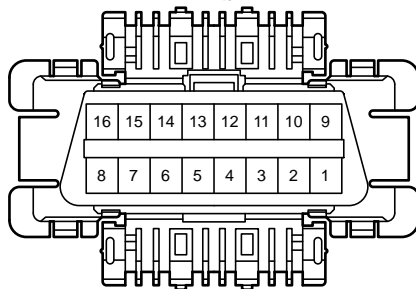

90980-12D97

K168  
White

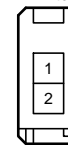

90980-12827

Electronically Controlled Transmission and A/T Indicator (2GR-FKS), Engine Control (2GR-FKS)

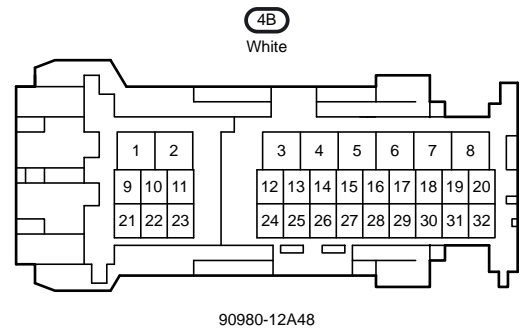
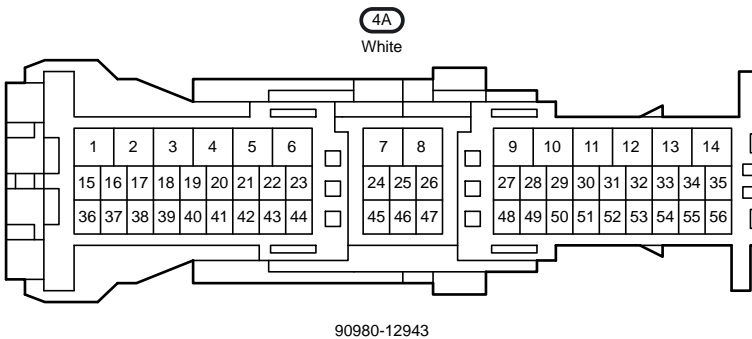
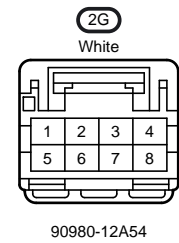
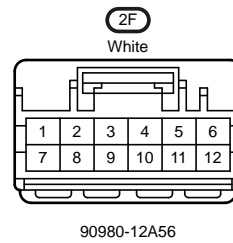
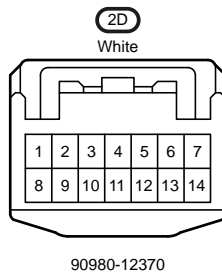
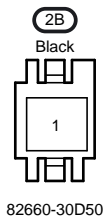
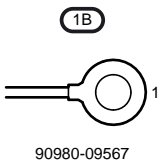
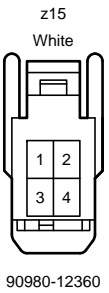
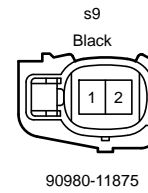
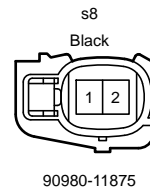
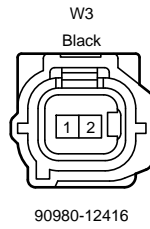
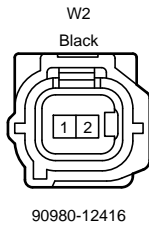
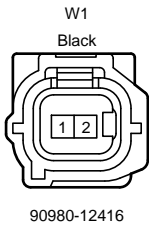
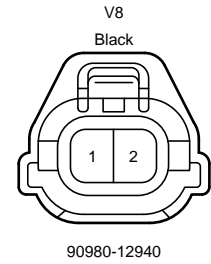
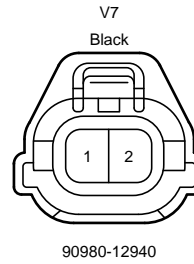
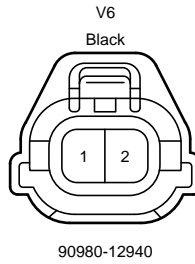
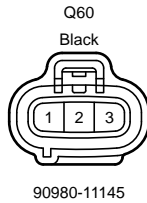
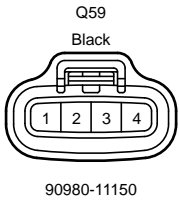
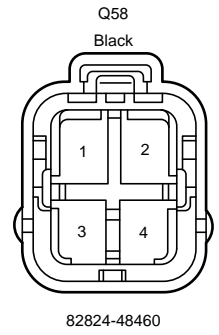
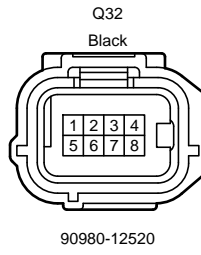
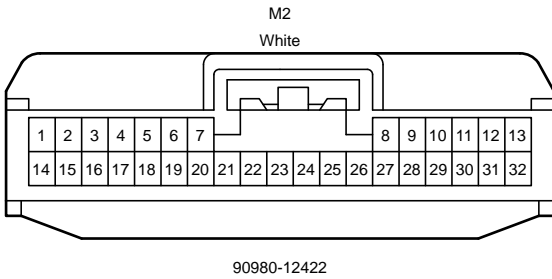

4C  
White

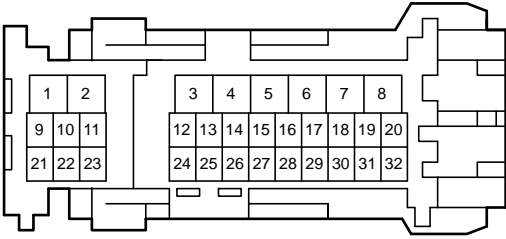

90980-12A47

AF1  
White

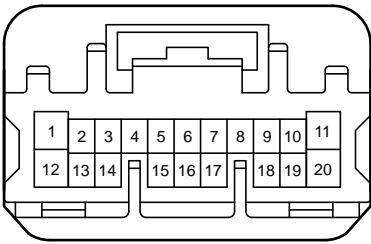

90980-12741

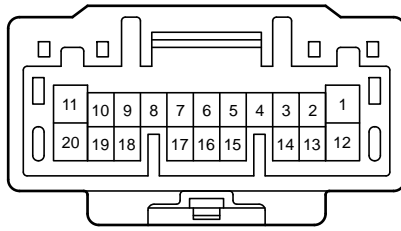

90980-12740

AF2  
Gray

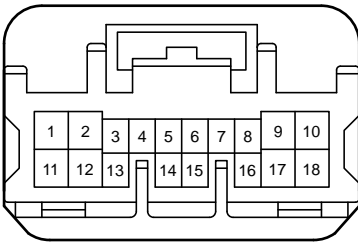

90980-12739

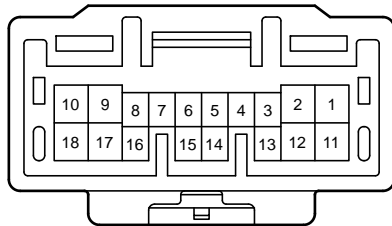

90980-12738

AQ1  
White

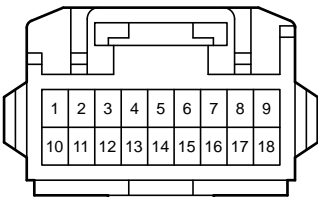

82824-53070

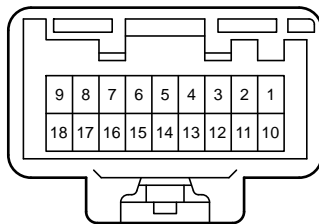

82824-53060

Electronically Controlled Transmission and A/T Indicator (2GR-FKS), Engine Control (2GR-FKS)

AQ2

White

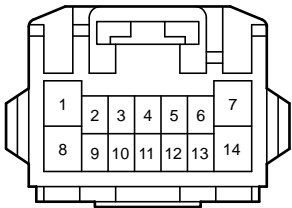

82824-53090

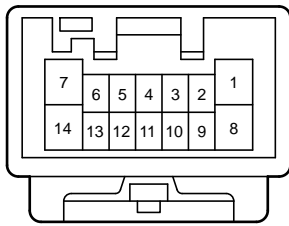

82824-53080

F13

Black

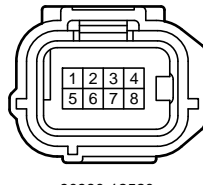

90980-12520



90980-12519

FJ2

Black

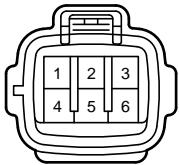

90980-11194

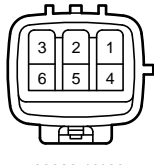

90980-11193

FV2

Gray



90980-11034



90980-11033

FW3

Gray

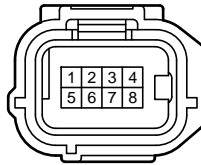

90980-12520

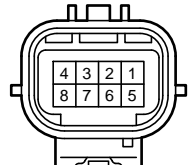

90980-12519

Fs4

Gray



90980-10942

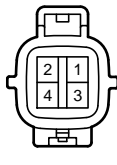

90980-10941

KA1

White

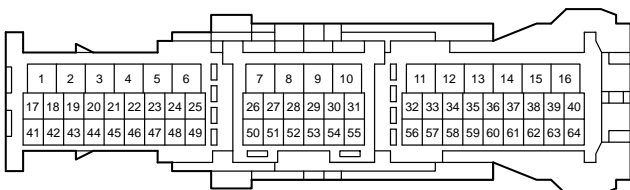

90980-12774

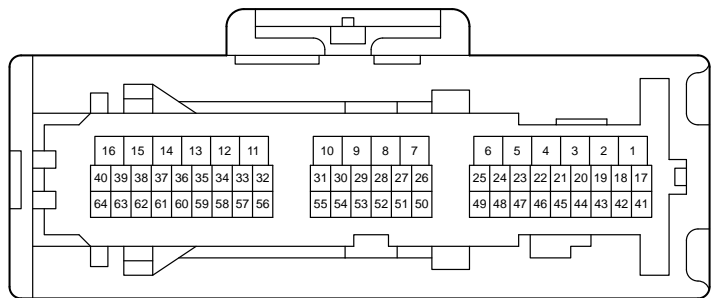

90980-12798

KA2

White

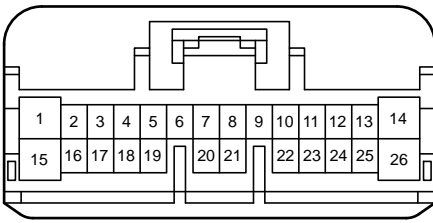

90980-12771

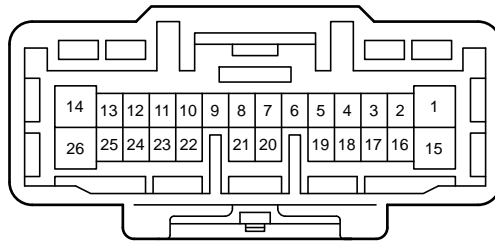

90980-12770

KA4

White

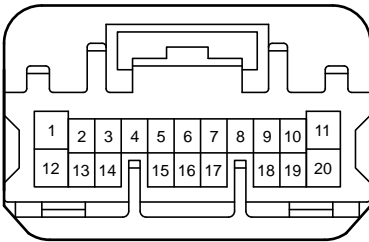

90980-12741

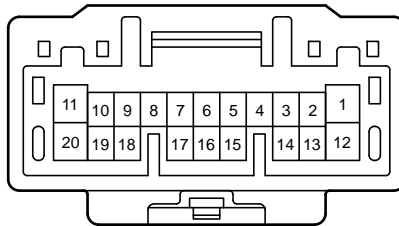

90980-12740

KA7

White

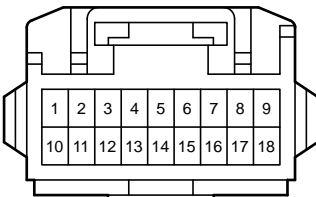

82824-53070

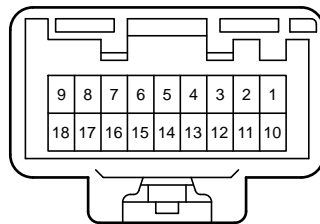

82824-53060

MK1

White

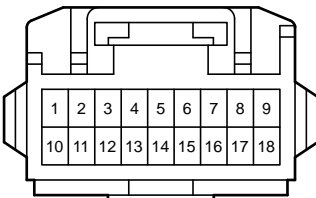

82824-53070

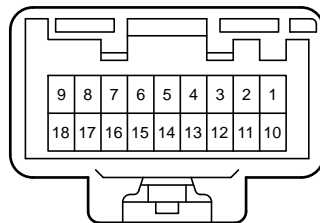

82824-53060