

FOREWORD

Congratulations on your selection of this Lexus. In Lexus vehicles we have invested all our engineering and design resources; all the know-how we have gained in over 60 years of making automobiles; the highest motivation of our most talented employees; and our tradition of incessant striving toward ever greater quality.

This Owner's Manual explains the features of your new Lexus. Please read it and follow the instructions carefully so that you can enjoy many years of safe motoring.

When it comes to service, remember that your Lexus dealer knows your vehicle very well and is interested in your complete satisfaction. Your Lexus dealer will provide quality maintenance and any other assistance you may require.

If there is not a Lexus dealer near you, or you need emergency assistance for any reason, please call the following number:

U.S. OWNERS

- When traveling in the U.S. mainland or Canada:
Lexus Roadside Assistance 1-800-25-LEXUS (Toll-Free)
(1-800-255-3987)
- HAWAII:
Lexus Customer Service Assistance 1-800-25-LEXUS (Toll-Free)
(1-800-255-3987)

CANADIAN OWNERS

- When traveling in Canada or the U.S. mainland:
Lexus Roadside Assistance/Customer Service 1-800-26-LEXUS (Toll-Free)
(1-800-265-3987)

Please leave this Owner's Manual in this vehicle at the time of resale. The next owner will need this information also.

All information and specifications in this manual are current at the time of printing. However, because of the Lexus policy of continual product improvement, we reserve the right to make changes at any time without notice.

Please note that this manual applies to all models and explains all equipment, including options. Therefore, you may find some explanations for equipment not installed on your vehicle.

TOYOTA MOTOR CORPORATION

IMPORTANT INFORMATION ABOUT YOUR LEXUS

IMPORTANT INFORMATION ABOUT YOUR LEXUS

Occupant restraint systems

Lexus encourages you and your family to take the time to read Section 1-6 of this Owner's Manual carefully. In terms of helping you understand how you can receive the maximum benefit of the occupant restraint systems this vehicle provides, Section 1-6 of this Owner's Manual is the most important section for you and your family to read.

Section 1-6 describes the function and operation concerning seats, seat belts, SRS airbags and child restraint systems of this vehicle and some potential hazards you should be aware of. These systems work together along with the overall structure of this vehicle in order to provide occupant restraint in the event of a crash. The effect of each system is enhanced when it is used properly and together with other systems. No single occupant restraint system can, by itself, provide you or your family with the equal level of restraint which these systems can provide when used together. That is why it is important for you and your family to understand the purpose and proper use of each of these systems and how they relate to each other.

The purpose of all occupant restraint systems is to help reduce the possibility of death or serious injury in the event of a collision. None of these systems, either individually or together, can ensure that there is no injury in the event of collision. However, the more you know about these systems and how to use them properly, the greater your chances become of surviving an accident without death or serious injury.

Seat belts provide the primary restraint to all occupants of the vehicle, and every occupant of the vehicle should wear seat belts properly at all times. Children should always be secured in child restraint systems that are appropriate for their age and size. SRS (Supplemental Restraint System) airbags are, as their names imply, designed to work with, and be supplemental to, seat belts and are not substitutes for them. SRS airbags can be very effective in reducing the risk of head, chest and knee injuries by preventing contact of the head, chest and knee with interior portions of the vehicle.

In order to be effective, the SRS airbags must deploy with tremendous speed. The rapid deployment of the SRS airbags makes the SRS airbags themselves potential sources of serious injury if an occupant is too close to an airbag, or if an object or some part of his or her body has been placed between the occupant and the airbag at the time of deployment. This is just one example of how the instructions in Section 1-6 of this Owner's Manual will help ensure proper use of the occupant restraint systems, and increase the safety they can provide to you and your family in the event of an accident.

Lexus recommends you to read the provisions in Section 1-6 carefully and refer to them as needed during your time of ownership of this vehicle.

IMPORTANT INFORMATION ABOUT YOUR LEXUS

New vehicle warranty

Your new vehicle is covered by the following Lexus limited warranties:

- New vehicle warranty
- Emission control systems warranty
- Others

For further information, please refer to the "Owner's Guide", "Owner's Manual Supplement" or "Warranty Booklet".

Your responsibility for maintenance

It is the owner's responsibility to make sure the specified maintenance is performed. Section 5 of this Owner's Manual gives details of these maintenance requirements. Included in Section 6 is general maintenance. For scheduled maintenance information, please refer to the "Owner's Manual Supplement / Scheduled Maintenance".

Important health and safety information about your Lexus

CAUTION

- **WARNING: Engine exhaust, some of its constituents, and a wide variety of automobile components contain or emit chemicals known to the State of California to cause cancer and birth defects and other reproductive harm. In addition, oils, fuels and fluids contained in vehicles as well as waste produced by component wear contain or emit chemicals known to the State of California to cause cancer and birth defects or other reproductive harm.**
- **Battery posts, terminals and related accessories contain lead and lead compounds. Wash your hands after handling. Used engine oil contains chemicals that have caused cancer in laboratory animals. Always protect your skin by washing thoroughly with soap and water.**

IMPORTANT INFORMATION ABOUT YOUR LEXUS

Accessories, spare parts and modification of your Lexus

A wide variety of non-genuine spare parts and accessories for Lexus vehicles are currently available in the market. You should know that Toyota does not warrant these products and is not responsible for their performance, repair, or replacement, or for any damage they may cause to, or adverse effect they may have on, your Lexus vehicle.

This vehicle should not be modified with non-genuine Lexus products. Modification with non-genuine Lexus products could affect its performance, safety or durability, and may even violate governmental regulations. In addition, damage or performance problems resulting from the modification may not be covered under warranty.

Spark ignition system of your Lexus

The spark ignition system in your Lexus meets all requirements of the Canadian Interference-Causing Equipment Standard.

Installation of a mobile two-way radio system

As the installation of a mobile two-way radio system in your vehicle could affect electronic systems such as the multiport fuel injection system/sequential multiport fuel injection system, cruise control system, dynamic radar/laser cruise control system, anti-lock brake system, SRS airbag system and seat belt pretensioner system, be sure to check with your Lexus dealer for precautionary measures or special instructions regarding installation.

Tires and loading on your Lexus

Underinflated or overinflated tire pressure and the excess load may result in the deterioration of steering ability and braking ability, leading to an accident. Check the tire inflation pressure periodically and be sure to keep the load limits given in this Owner's Manual. For details about tire inflation pressure and load limits, see pages 476 and 388.

Scrapping of your Lexus

The SRS airbag and seat belt pretensioner devices in your Lexus contain explosive chemicals. If the vehicle is scrapped with the airbags and seat belt pretensioners left as they are, this may cause an accident such as a fire. Be sure to have the system of the SRS airbag and seat belt pretensioner removed and disposed of by a qualified service shop or by your Lexus dealer before you scrap your vehicle.

HOW TO USE THIS MANUAL

The contents of this manual are explained briefly on this page to help you make the best use of the manual. Please read this page and the rest of the Owner's Manual carefully to make sure you fully understand the operation of your vehicle.

This will help you enjoy safe and comfortable driving.

TABLE OF CONTENTS

The table of contents and the pictorial index provide easy reference to the appropriate pages.

BASIC OPERATION - QUICK REFERENCE

Operation of basic equipment is briefly explained in an easily understandable way for quick reference.

SECTION 1 - INSTRUMENTS AND CONTROLS

The vehicle's equipment is divided into the 7 groups listed below. Use of the equipment is explained, including any points you should pay particular attention to.

1. Keys and doors
2. Switches
3. Gauges, meters and service reminder indicators
4. Interior equipment
5. Exterior equipment
6. Occupant restraint systems
7. Steering wheel and mirrors

SECTION 2 - AIR CONDITIONING AND AUDIO

The features of the vehicle's air conditioning and audio are explained in detail. Be sure to read this section so that you can make full use of them.

SECTION 3 - STARTING AND DRIVING

Starting the engine, driving, stopping, operation of features affecting vehicle handling, hints on vehicle safety and safe driving techniques are all explained. Please read everything in this section, and remember - drive safely!

SECTION 4 - IN CASE OF AN EMERGENCY

This section explains what to do in the event of an urgent situation such as the engine not starting or getting a flat tire, etc. If such a problem occurs, check the contents of this Owner's Manual and follow the instructions given.

SECTION 5 - MAINTENANCE

This section explains the importance of regular maintenance. Regular and periodic inspection and maintenance of your Lexus will help to keep your vehicle in its best condition.

SECTION 6 - SERVICE PROCEDURES AND SPECIFICATIONS

Simple maintenance procedure and service data are provided here for your reference should you wish to perform inspection and maintenance yourself.

INDEX

The page number is listed for each item in the Owner's Manual so that you can rapidly find the item and page you are searching for.

HOW TO USE THIS MANUAL

GAS STATION INFORMATION

The information you need to know for appropriate servicing at the gas station is provided here.

QUICK INDEX

This is designed so that you can quickly find the needed information when an urgent situation arises.

Safety symbol

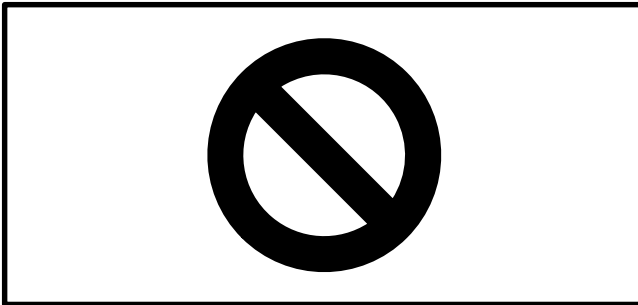

In this manual, you will also see a circle with a slash through it. This means "Do not", "Do not do this", or "Do not let this happen".

Safety and vehicle damage warnings

In this manual you will see CAUTION and NOTICE warnings. These are used in the following ways:

CAUTION

This is a warning against anything which may cause injury to people if the warning is ignored. You are informed about what you must or must not do in order to reduce the risk of injury to yourself and others.

NOTICE

This is a warning against anything which may cause damage to the vehicle or its equipment if the warning is ignored. You are informed about what you must or must not do in order to avoid or reduce the risk of damage to your Lexus and its equipment.

Your Lexus Owner's Manual provides you with a considerable amount of information. To use this information most effectively, please take the time to familiarize yourself with the contents and use of the manual.

INSTRUMENT PANEL (Vehicles with navigation system)

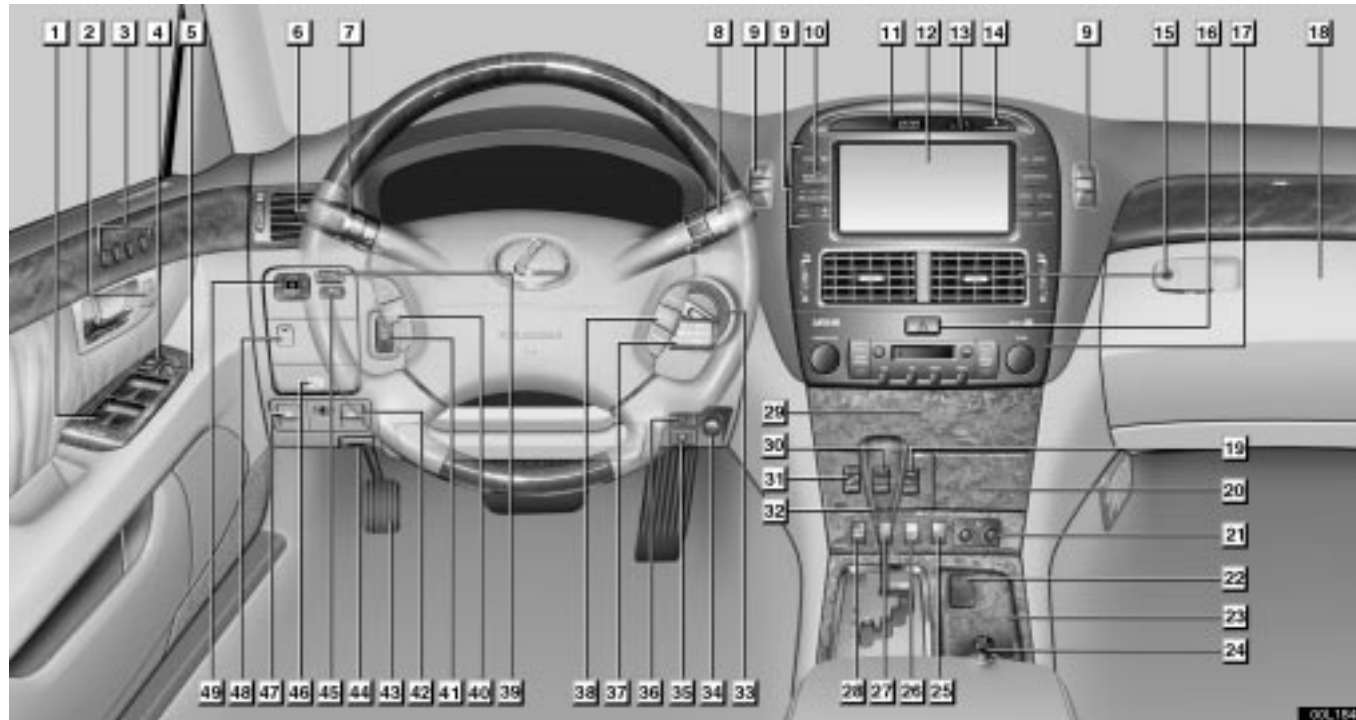

1 Power window switches 64	3 Driving position memory switch 217
2 Shoulder anchor control switch 168	4 Door lock switch 48

PICTORIAL INDEX

5	Window lock switch	65	26	Rear seat and rear head restraints return switch	160
6	Side vents	250	27	Traction control system off switch	358
7	Headlight, turn signal and fog light switches	54, 57, 58	28	Rear electric sunshade switch	134
8	Wiper and washer switch	58	29	CD automatic changer	279
9	Automatic air conditioning controls	235, 237	30	Height control switch	355
10	Rear window and outside rear view mirror defogger switch	63	31	Damping mode select switch	357
11	Clock	113	32	Automatic transmission selector lever	301
12	Lexus park assist system/Rear view monitor/Navigation system display (See "Navigation System Owner's Manual")	312/318	33	Ignition switch	295, 298
13	Outside temperature display	114	34	Volume adjustment knob	30, 39
14	Front passenger's seat belt reminder light	84	35	Smart key system cancel switch	34
15	Center vents	249	36	Tire pressure warning system reset switch	367
16	Emergency flasher switch	68	37	Cruise control switch/Dynamic radar/laser cruise control switch	322/325
17	Car audio	257	38	Multi-information display control switch	89
18	Glove box	119	39	Rear view mirror folding switch	229
19	Driving pattern selector switch	301	40	Steering pad switches	285
20	Auxiliary box	126	41	Adaptive front-lighting system cancel switch	56
21	Seat heater switches/Climate control seat switches	69/71	42	Trunk lid opener	141
22	Power outlet	117	43	Parking brake	299
23	Auxiliary box if power outlet is selected/Ashtray if cigarette lighter is selected	126/116	44	Hood opener	139
24	Cigarette lighter	116	45	Lexus park assist system switch	312
25	Headlight cleaner switch	62	46	Parking brake release lever	299
			47	Fuel filler door opener	143
			48	Coin box	124
			49	Power rear view mirror control switches	228

For detailed information, refer to the description given in each section.

INSTRUMENT PANEL (Vehicles without navigation system)

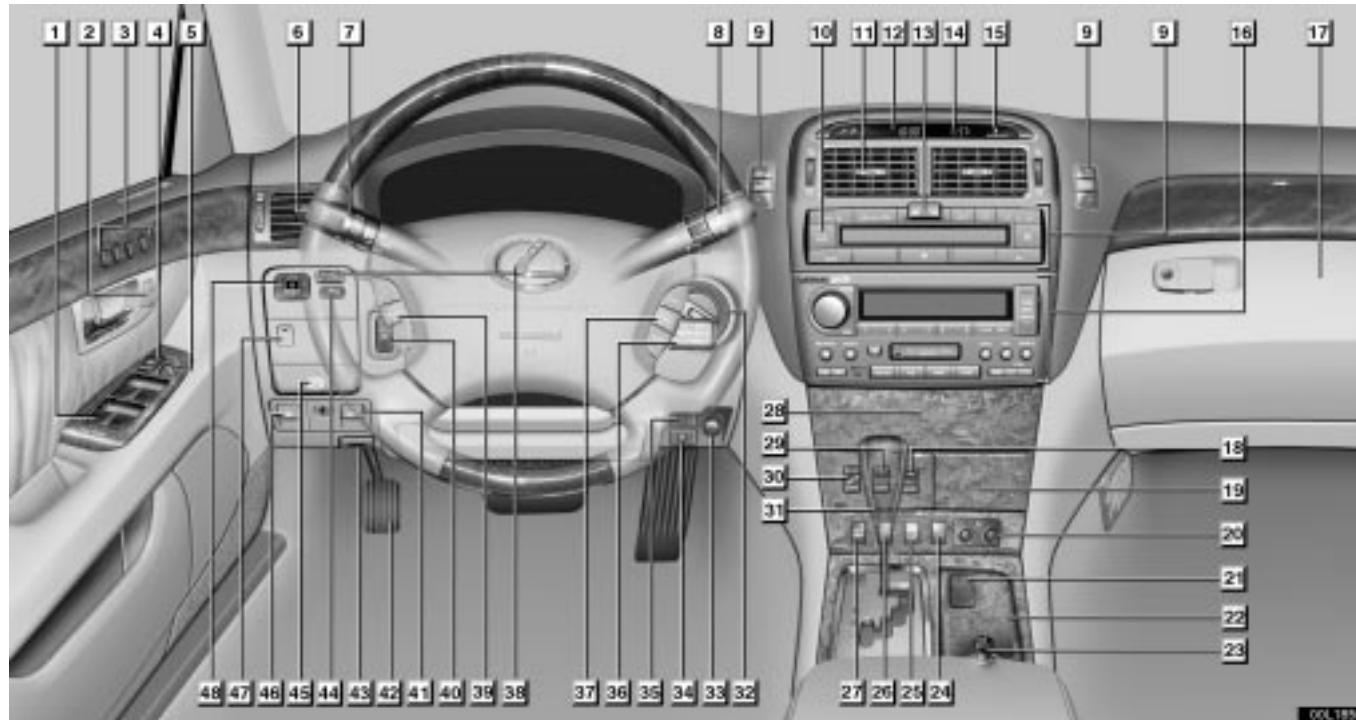

1 Power window switches 64	3 Driving position memory switch 217
2 Shoulder anchor control switch 168	4 Door lock switch 48

PICTORIAL INDEX

5	<i>Window lock switch</i>	65	26	<i>Traction control system off switch</i>	358
6	<i>Side vents</i>	250	27	<i>Rear electric sunshade switch</i>	134
7	<i>Headlight, turn signal and fog light switches</i>	54, 57, 58	28	<i>CD automatic changer</i>	279
8	<i>Wiper and washer switch</i>	58	29	<i>Height control switch</i>	355
9	<i>Automatic air conditioning controls</i>	235, 237	30	<i>Damping mode select switch</i>	357
10	<i>Rear window and outside rear view mirror defogger switch</i>	63	31	<i>Automatic transmission selector lever</i>	301
11	<i>Center vents</i>	249	32	<i>Ignition switch</i>	295, 298
12	<i>Clock</i>	113	33	<i>Volume adjustment knob</i>	30, 39
13	<i>Emergency flasher switch</i>	68	34	<i>Smart key system cancel switch</i>	34
14	<i>Outside temperature display</i>	114	35	<i>Tire pressure warning system reset switch</i>	367
15	<i>Front passenger's seat belt reminder light</i>	84	36	<i>Cruise control switch/Dynamic radar/laser cruise control switch</i>	322/325
16	<i>Car audio</i>	257	37	<i>Multi-information display control switch</i>	89
17	<i>Glove box</i>	119	38	<i>Rear view mirror folding switch</i>	229
18	<i>Driving pattern selector switch</i>	301	39	<i>Steering pad switches</i>	285
19	<i>Auxiliary box</i>	126	40	<i>Adaptive front-lighting system cancel switch</i>	56
20	<i>Seat heater switches/ Climate control seat switches</i>	69/71	41	<i>Trunk lid opener</i>	141
21	<i>Power outlet</i>	117	42	<i>Parking brake</i>	299
22	<i>Auxiliary box if power outlet is selected/ Ashtray if cigarette lighter is selected</i>	126/116	43	<i>Hood opener</i>	139
23	<i>Cigarette lighter</i>	116	44	<i>Lexus park assist system switch</i>	312
24	<i>Headlight cleaner switch</i>	62	45	<i>Parking brake release lever</i>	299
25	<i>Rear seat and rear head restraints return switch</i>	160	46	<i>Fuel filler door opener</i>	143
			47	<i>Coin box</i>	124
			48	<i>Power rear view mirror control switches</i>	228

For detailed information, refer to the description given in each section.

INSTRUMENT CLUSTER (Vehicles sold in U. S. A.)

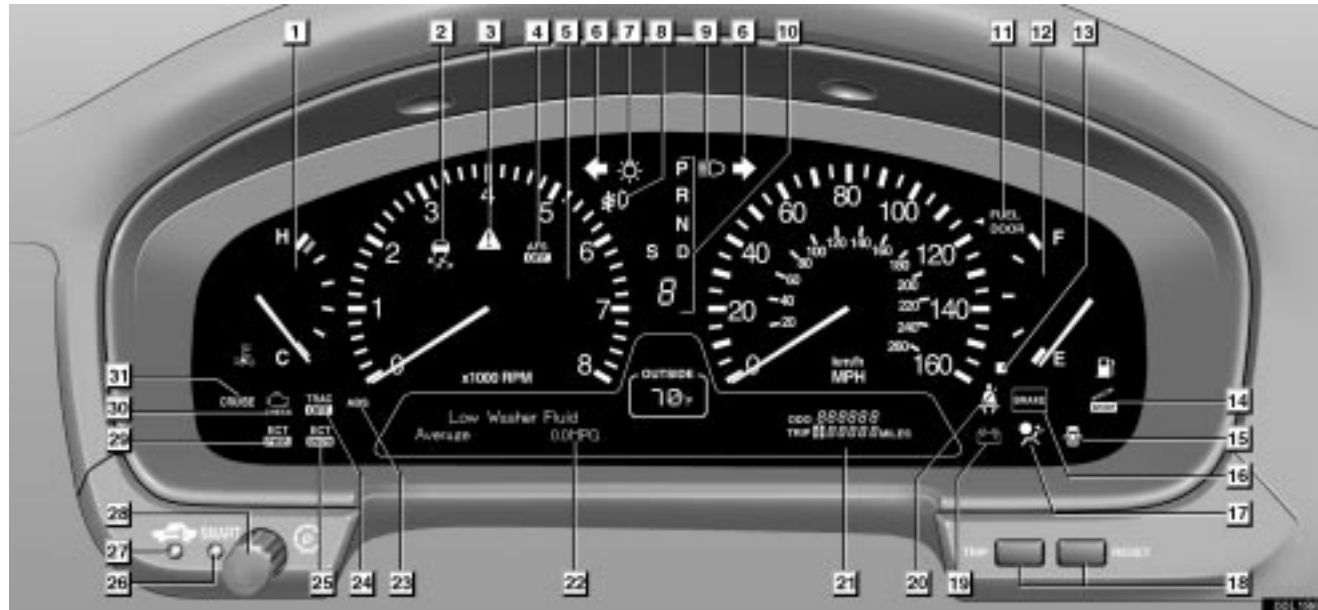

PICTORIAL INDEX

1	<i>Engine coolant temperature gauge</i>	79	16	<i>Brake system warning light</i>	83
2	<i>Slip indicator light</i>	358, 361	17	<i>SRS warning light</i>	84
3	<i>Master warning light</i>	86	18	<i>ODO/TRIP RESET button</i>	81
4	<i>Adaptive front-lighting system off indicator light</i>	56	19	<i>Discharge warning light</i>	85
5	<i>Tachometer</i>	80	20	<i>Driver's seat belt reminder light</i>	84
6	<i>Turn signal indicator light</i>	57	21	<i>Odometer and trip meter</i>	81
7	<i>Headlight indicator light</i>	54	22	<i>Multi- information display</i>	89
8	<i>Fog light indicator light</i>	58	23	<i>Anti-lock brake system warning light</i>	86
9	<i>Headlight high beam indicator light</i>	57	24	<i>Traction control system OFF indicator light</i>	358
10	<i>Automatic transmission indicator lights</i>	301	25	<i>Snow mode indicator light</i>	311
11	<i>Fuel filler door indicator</i>	143	26	<i>Smart indicator light</i>	20, 295
12	<i>Fuel gauge</i>	79	27	<i>Security indicator light</i>	50
13	<i>Low fuel level warning light</i>	87	28	<i>Instrument panel light control</i>	107
14	<i>Damping mode indicator light</i>	357	29	<i>Power mode indicator light</i>	311
15	<i>Open door warning light</i>	87	30	<i>Malfunction indicator lamp</i>	85
			31	<i>Cruise control indicator light</i>	322

For detailed information, refer to the description given in each section.

INSTRUMENT CLUSTER (Vehicles sold in Canada)

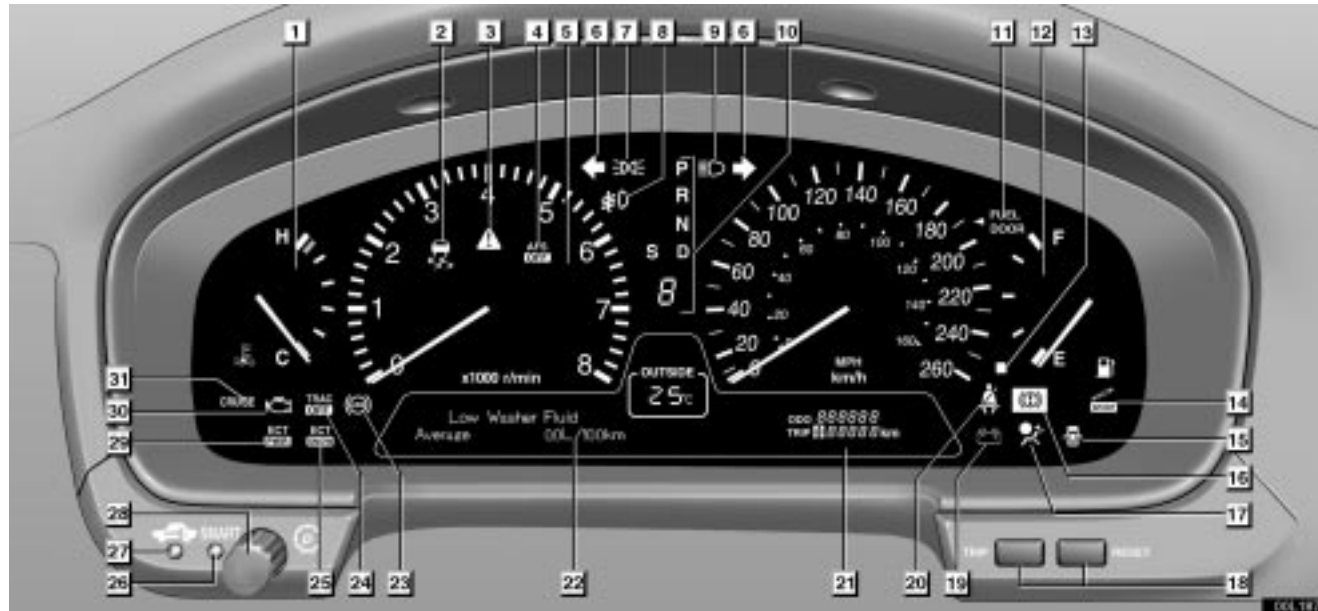

PICTORIAL INDEX

1	<i>Engine coolant temperature gauge</i>	79	16	<i>Brake system warning light</i>	83
2	<i>Slip indicator light</i>	358, 361	17	<i>SRS warning light</i>	84
3	<i>Master warning light</i>	86	18	<i>ODO/TRIP RESET button</i>	81
4	<i>Adaptive front-lighting system off indicator light</i>	56	19	<i>Discharge warning light</i>	85
5	<i>Tachometer</i>	80	20	<i>Driver's seat belt reminder light</i>	84
6	<i>Turn signal indicator light</i>	57	21	<i>Odometer and trip meter</i>	81
7	<i>Tail indicator light</i>	54	22	<i>Multi-information display</i>	89
8	<i>Fog light indicator light</i>	58	23	<i>Anti-lock brake system warning light</i>	86
9	<i>Headlight high beam indicator light</i>	57	24	<i>Traction control system OFF indicator light</i>	358
10	<i>Automatic transmission indicator lights</i>	301	25	<i>Snow mode indicator light</i>	311
11	<i>Fuel filler door indicator</i>	143	26	<i>Smart indicator light</i>	20, 295
12	<i>Fuel gauge</i>	79	27	<i>Security indicator light</i>	50
13	<i>Low fuel level warning light</i>	87	28	<i>Instrument panel light control</i>	107
14	<i>Damping mode indicator light</i>	357	29	<i>Power mode indicator light</i>	311
15	<i>Open door warning light</i>	87	30	<i>Malfunction indicator lamp</i>	85
			31	<i>Cruise control indicator light</i>	322

For detailed information, refer to the description given in each section.

OVERHEAD CONSOLE



- 1** Moon roof switches 145
- 2** Garage door opener switches 119
- 3** Lexus Link System switches 419

REAR ARMREST



- 1** Rear seat control switches 159
- 2** Refreshing rear seat switches 76
- 3** Rear air conditioning control switches 251
- 4** Cup holders 123
- 5** Rear electric sunshade switch 134
- 6** Rear seat heater switches 69
- 7** Rear climate control seat switches 72
- 8** Audio rear control switches 284

For detailed information, refer to the description given in each section.

SEAT AND STEERING WHEEL

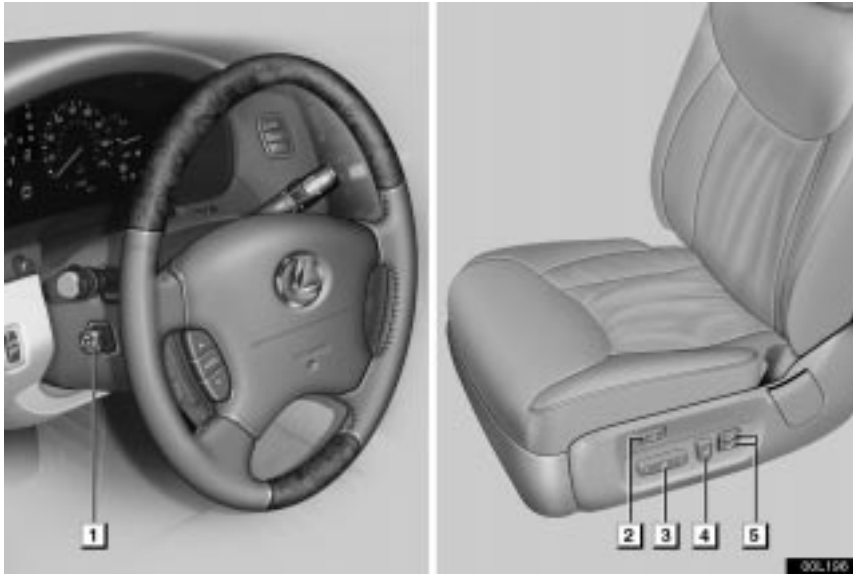

- 1** *Tilt and telescopic steering adjustment switch* 225
- 2** *Seat cushion length control switch* 154
- 3** *Seat position, seat cushion angle and height control switch* 154, 156
- 4** *Seatback angle and head restraint control switch* 155, 162
- 5** *Lumbar support control switches* 156

For detailed information, refer to the description given in each section.

EXTERIOR VIEW

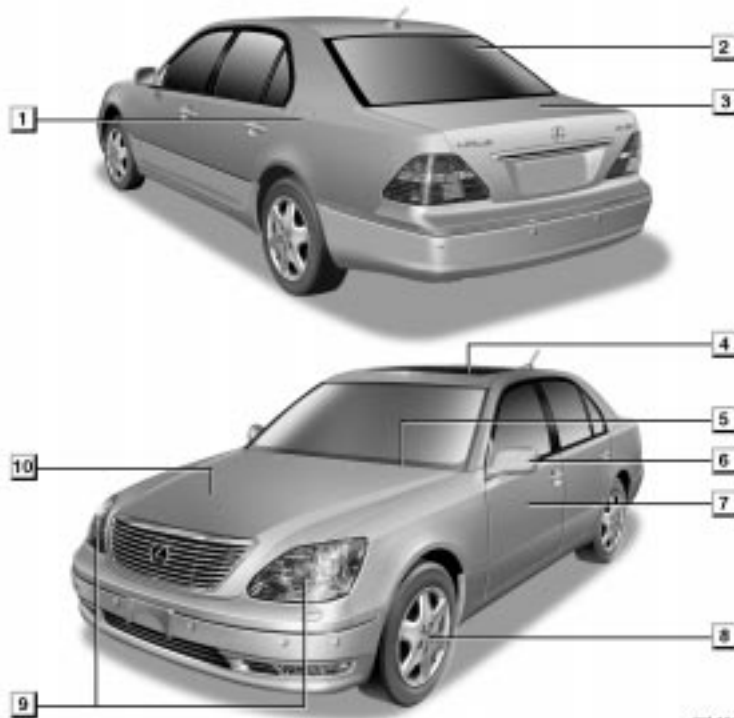

1	<i>Fuel filler door</i>	143
2	<i>Rear window defogger</i>	63
3	<i>Trunk lid</i>	140
4	<i>Moon roof</i>	145
5	<i>Wiper and washer</i>	58, 512
6	<i>Outside rear view mirror</i>	227
7	<i>Door</i>	46
8	<i>Tire and wheel</i>	476
9	<i>Headlight</i>	54, 514
10	<i>Hood</i>	139

For detailed information, refer to the description given in each section.

BASIC OPERATION

QUICK REFERENCE

Driver's seat	2
Steering wheel	3
Automatic transmission	4
Headlight and turn signal switch	6
Wiper switch	7

QUICK REFERENCE

1. DRIVER'S SEAT

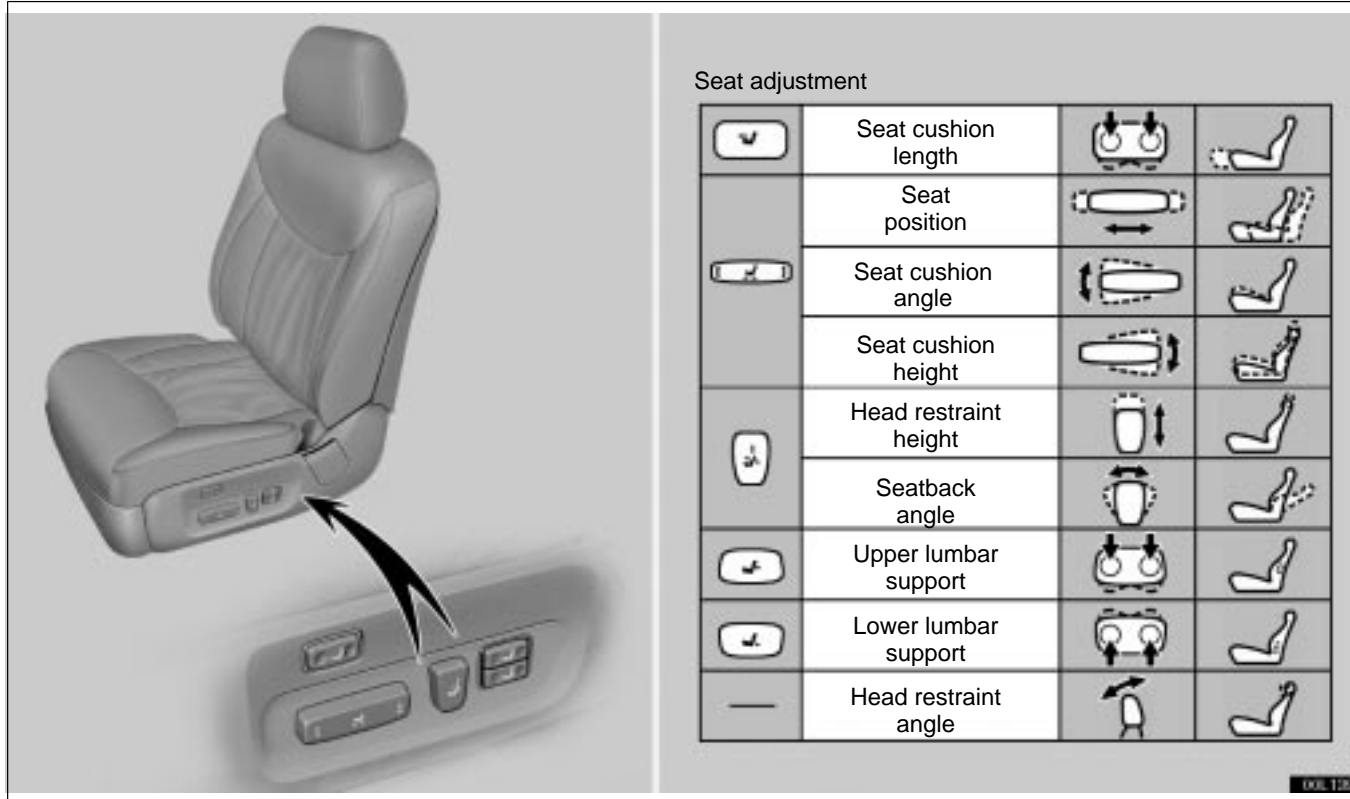

2. STEERING WHEEL

- TILT STEERING WHEEL

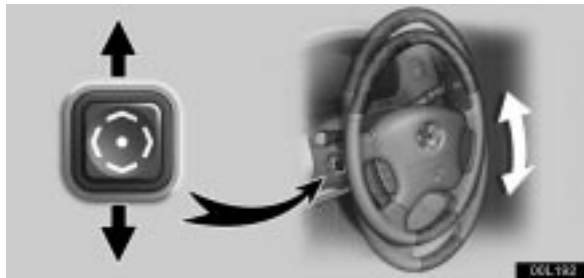

To tilt the steering wheel up or down to the desired angle, push the control switch in the required direction and release the button when the steering wheel reaches the desired angle.

- TELESCOPIC STEERING WHEEL

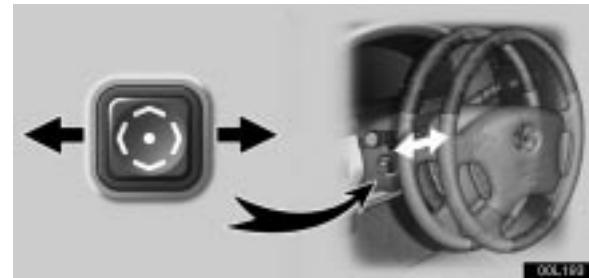

To move the steering wheel to the desired position, push the control switch away from you or pull it toward you until the steering wheel reaches the desired position.

QUICK REFERENCE

3. AUTOMATIC TRANSMISSION



SELECTOR LEVER POSITION

- P:** Parking, engine starting and key removal position
- R:** Reverse position
- N:** Neutral position
- D:** Normal driving position
(Shifting into overdrive possible)
- S:** "S" mode driving
 - +**: Upshifting
 - : Downshifting

OPERATION OF SELECTOR LEVER

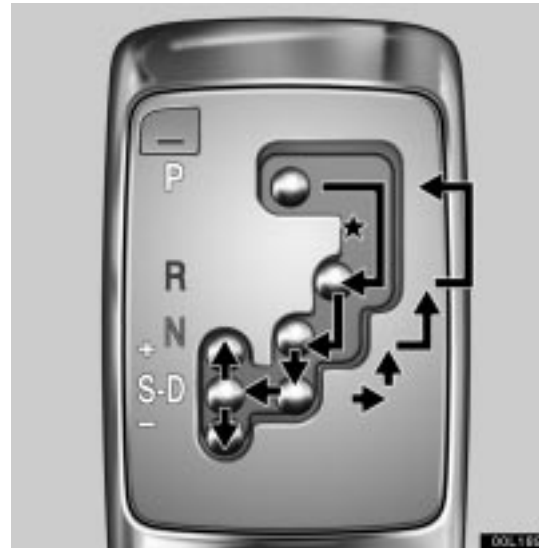

- ★ Shift while pressing the brake pedal.
(Ignition switch must be in the "ON" position.)

QUICK REFERENCE

NOTE:



Vehicles with the cruise control: When the cruise control is being used, even if you downshift from “D” or “6” (sixth range) to “5” (fifth range), or “D” or “5” (fifth range) to “4” (fourth range), engine braking will not be enabled because the cruise control is not cancelled. For vehicle speed reduction, see page 324. Vehicles with the dynamic radar/laser cruise control: When the cruise control is being used in the conventional (fixed speed) cruise control mode or in the vehicle-to-vehicle distance control mode, even if you downshift from “D” or “6” (sixth range) to “5” (fifth range) or D”, or “5” (fifth range) to “4” (fourth range), engine braking will not be enabled because the cruise control is not cancelled. For vehicle speed reduction, see pages 354 and 339.

QUICK REFERENCE



4. HEADLIGHT AND TURN SIGNAL SWITCH



● HEADLIGHT SWITCH

With the ignition OFF



	Parking, tail, license plate, side marker and instrument panel lights turn on.
	Headlights also turn on.
	Automatic light control

With the engine started and parking brake released





	Parking, tail, license plate, side marker and instrument panel lights turn on.
	Headlights also turn on at full intensity.
	Automatic light control





	High beam
	Headlight flasher

● TURN SIGNAL SWITCH

	Right or left turn
	Lane change (Right or left)

5. WIPER SWITCH

Intermittent operation type	
	Mist wiper operation
	Intermittent operation
	Low speed operation
	High speed operation
	Washer on

Raindrop detection type	
	Mist wiper operation
	Automatic operation
	Low speed operation
	High speed operation
	Washer on

SECTION 1 - 1

INSTRUMENTS AND CONTROLS

Keys and doors

Keys	10
Engine immobilizer system	17
Smart key system	20
Wireless remote control	36
Doors	46
Theft deterrent system	50

KEYS AND DOORS

KEYS

Vehicles equipped with smart key system (Type A)

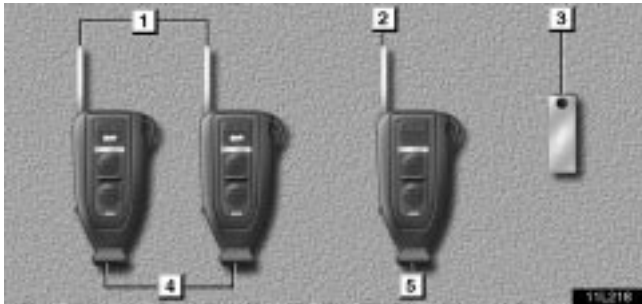

- 1** Mechanical keys (attached to the master keys) - These keys work for the doors, trunk, trunk main switch, glove box and trunk storage extension door, but cannot start the engine.
- 2** Mechanical key (attached to the sub key) - This key works for the doors, but cannot start the engine and does not work for the trunk, trunk main switch, glove box and trunk storage extension door.
- 3** Key number plate - Keep the plate in a safe place such as your wallet, not in the vehicle.
- 4** Smart keys (master keys) - These keys will activate the smart key system. They will not work for the trunk main switch, glove box and trunk storage extension door.

- 5** Smart key (sub key) - This key does not work for the trunk, trunk main switch, glove box and trunk storage extension door. This key cannot activate the smart key system.

Before you use these keys, be sure to read "Smart key system" on page 20.

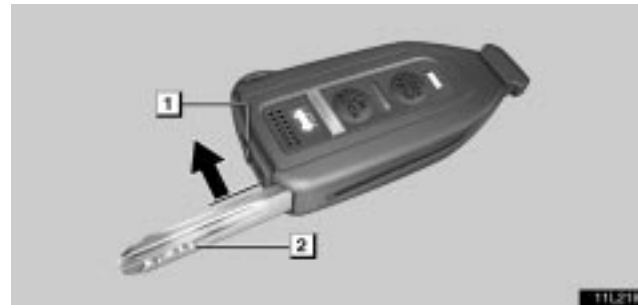

► Using a mechanical key

- 1** Lock switch
- 2** Mechanical key

When you use the mechanical key included on the side of the smart key, slide the lock switch in the arrow direction and pull the key as shown. To put the key back, slide the lock switch in the arrow direction and slide the key back. Be sure to put the key back when not in use.

A transponder chip for the engine immobilizer system has been placed in the master and sub keys. These chips are required for the system to function correctly, so be careful not to lose these keys. If you make your own duplicate key, you will not be able to cancel the system or start the engine.

To protect items locked in the trunk or glove box when using valet parking, leave the sub key with the attendant.

Since the doors and the trunk lid can be locked without a key, you should always carry a spare master key in case you accidentally lock your keys inside the vehicle.

If you should lose your keys or if you need additional keys, duplicates can be made by a Lexus dealer using the key number.

We recommend writing down the key number and storing it in a safe place.

Flat keys



► **1** Mechanical flat key **2** Engine start flat key

A mechanical flat key and an engine start flat key are included in the key case. Both flat keys are not equipped with smart key system.

The mechanical flat key works in every lock, but cannot be used to start the engine.

As a transponder chip is built in the engine start flat key, you can start the engine only with this key.

A transponder chip for the engine immobilizer system has been placed in the engine start flat key. This chip is required for the system to function correctly, so be careful not to lose this key. If you make your own duplicate key, you will not be able to cancel the system or start the engine.

Insert your flat key plates in its key case as shown. We recommend that you always carry this with you for emergency use. Do not leave it in your vehicle.

KEYS AND DOORS

Starting the engine using an engine start flat key

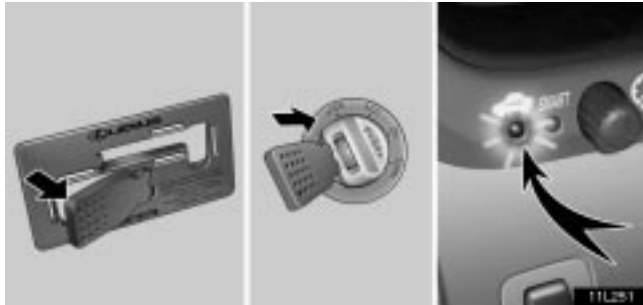

1. Remove the engine start flat key from the key case.
2. Insert it into the ignition switch.

The flashing security indicator light goes out. This means the engine immobilizer system is automatically canceled. (For details, see “Engine immobilizer system” on page 17.)

NOTICE

- **Do not let the key case become bent as the flat keys may fall out or become bent also.**
- **The flat keys are designed for emergency use only, so do not use them regularly instead of the other master keys.**



NOTICE

When using a key containing a transponder chip, observe the following precautions:

- **When starting the engine, do not use the key with a key ring resting on the key grip and do not press the key ring against the key grip. Doing so may prevent the engine from starting, or may cause the engine to stop soon after it starts.**

KEYS AND DOORS



- *When starting the engine, do not use the key in proximity with other transponder keys (including the flat key and keys of other vehicles), and do not press other key plates against the key grip. Doing so may prevent the engine from starting, or may cause the engine to stop soon after it starts. If this happens, remove the key once and then insert it again after removing other transponder keys (including the flat key and keys of other vehicles) from the ring or while gripping or covering them with your hand to start the engine.*



- *Do not bend the key grip or flat keys.*
- *Do not cover the key grip or engine start flat key with any material that cuts off electromagnetic waves.*
- *Do not knock the key or flat keys hard against other objects.*
- *Do not leave the key or flat keys exposed to high temperatures for a long period, such as on the dashboard or hood under direct sunlight.*
- *Do not put the key or flat keys in water or wash it in an ultrasonic washer.*
- *Do not use the key or engine start flat key with electromagnetic materials.*

KEYS AND DOORS

Vehicles not equipped with smart key system (Type B)

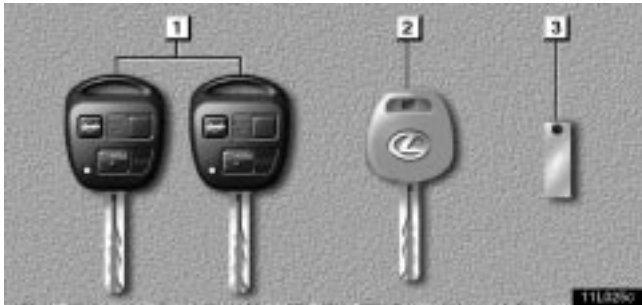

- 1 Master keys (black) - These keys work for every lock. For your Lexus dealer to make a new key with a built-in transponder chip, your dealer will need one of them.**
- 2 Sub key (gray) - This key will not open the trunk, trunk main switch, the glove box and trunk storage extension door.**
- 3 Key number plate - Keep the plate in a safe place such as your wallet, not in the vehicle.**

A transponder chip for the engine immobilizer system has been placed in the head of the master and sub keys. These chips are required for the system to function correctly, so be careful not to lose these keys. If you make your own duplicate key, you will not be able to cancel the system or start the engine.

To protect items locked in the trunk or glove box when using valet parking, leave the sub key with the attendant.

Since the doors and trunk lid can be locked without a key, you should always carry a spare master key in case you accidentally lock your keys inside the vehicle.

If you should lose your keys or if you need additional keys, duplicates can be made by a Lexus dealer using the key number.

We recommend writing down the key number and storing it in a safe place.

Flat key



As a transponder chip is built in its key case, you can start the engine with this key.

The flat key works in every lock.

A transponder chip for the engine immobilizer system has been placed in the key case of the flat key. This chip is required for the system to function correctly, so be careful not to lose this key. If you make your own duplicate key, you will not be able to cancel the system or start the engine.

Insert your flat key plate in its key case as shown. We recommend that you always carry this with you for emergency use. Do not leave it in your vehicle.

Starting the engine using a flat key

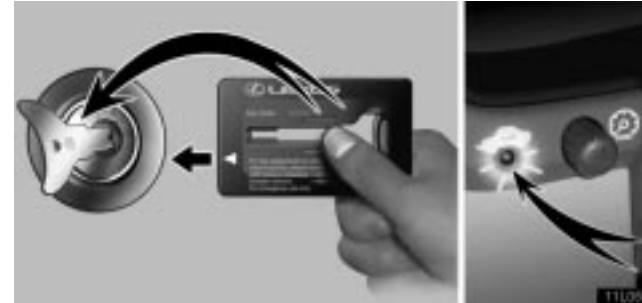

1. Remove the key plate from the key case.
2. Insert the key plate into the ignition switch. The security indicator light keeps flashing.
3. Bring the key case closer to the ignition switch within 10 seconds as indicated by the arrow head. The indicator light goes out. This means the engine immobilizer system is automatically canceled. (For details, see "Engine immobilizer system" on page 17.) You can put the key case away then. You cannot cancel the engine immobilizer system if 10 seconds have passed after you inserted the key plate. You need to remove the key plate from the ignition switch and try it again from the step 2.
4. Start the engine within 20 seconds after the security indicator light goes out. You cannot start the engine if 20 seconds have passed after the security indicator went off. You need to remove the key plate from the ignition switch and try it again from the step 2.

KEYS AND DOORS

NOTICE

- *Do not let the key case become bent as the key plate may fall out or become bent also.*
- *The flat key is designed for emergency use only, so do not use it regularly instead of the other master keys.*



When using a key containing a transponder chip, observe the following precautions:

- *When starting the engine, do not use the key with a key ring resting on the key grip and do not press the key ring against the key grip. Doing so may prevent the engine from starting, or may cause the engine to stop soon after it starts.*



- *When starting the engine, do not use the key in proximity with other transponder keys (including the flat key and keys of other vehicles), and do not press other key plates against the key grip. Doing so may prevent the engine from starting, or may cause the engine to stop soon after it starts. If this happens, remove the key once and then insert it again after removing other transponder keys (including the flat key and keys of other vehicles) from the ring or while gripping or covering them with your hand to start the engine.*



- ***Do not bend the key grip or flat key.***
- ***Do not cover the key grip or flat key with any material that cuts off electromagnetic waves.***
- ***Do not knock the key or flat key hard against other objects.***
- ***Do not leave the key or flat key exposed to high temperatures for a long period, such as on the dashboard or hood under direct sunlight.***
- ***Do not put the key or flat key in water or wash it in an ultrasonic washer.***
- ***Do not use the key or flat key with electromagnetic materials.***

ENGINE IMMOBILIZER SYSTEM

Deactivation using the smart key system



The engine immobilizer system is a theft prevention system. When you enter the vehicle carrying a smart key and push the ignition switch, the electronic code in the key is automatically checked to determine whether it corresponds to the registered ID code for the vehicle. If the smart indicator light comes on after the ID code verification, you can start the engine.

This system is automatically set when the ignition switch is turned to the "LOCK" position. At this time, the security indicator light flashes. When you push the ignition switch, the security indicator light goes out and the system is cancelled automatically, which enables the engine to start.

The engine immobilizer system cannot be cancelled if the cancel switch of the smart key system is turned on. For details, see "Deactivating the smart key system" on page 34.

KEYS AND DOORS

For your Lexus dealer to make you a new key with built-in transponder chip, your dealer will need your key number and master key. However, there is a limit to the number of additional keys your Lexus dealer can make for you.

If you make your own duplicate key, you will not be able to cancel the system or start the engine.

NOTICE

Do not modify, remove or disassemble the engine immobilizer system. If any unauthorized changes or modifications are made, proper operation of the system cannot be guaranteed.

Deactivation using the key



► **1** Type A **2** Type B

The engine immobilizer system is a theft prevention system. When you insert the key in the ignition switch, the transponder chip in the key's head transmits an electronic code to the vehicle. The engine will start only when the electronic code in the chip corresponds to the registered ID code for the vehicle.

The system is automatically set when the key is removed from the ignition switch. At this time, the security indicator light flashes. When you insert the key in the ignition switch, the security indicator light goes out and the system is canceled automatically, which enables the engine to start.

The transponder chip of the flat key is in its key case. You can cancel the engine immobilizer system using the flat key. (For details, see pages 12 and 15.)

KEYS AND DOORS

For your Lexus dealer to make you a new key with built-in transponder chip, your dealer will need your key number and master key or the flat key. However, there is a limit to the number of additional keys your Lexus dealer can make for you.

If you make your own duplicate key, you will not be able to cancel the system or start the engine.

For vehicles sold in U.S.A.

**FCC ID: MOZRI-20BTY
MADE IN JAPAN**

**FCC ID: MOZRI-15HTY
MADE IN JAPAN**

This device complies with Part 15 of the FCC Rules. Operation is subject to the following two conditions: (1) This device may not cause harmful interference, and (2) this device must accept any interference received, including interference that may cause undesired operation.

CAUTION

Changes or modifications not expressly approved by the party responsible for compliance could void the user's authority to operate the equipment.

For vehicles sold in Canada

This device complies with RSS-210 of Industry Canada. Operation is subject to the following two conditions: (1) This device may not cause interference, and (2) this device must accept any interference, including interference that may cause undesired operation of the device.

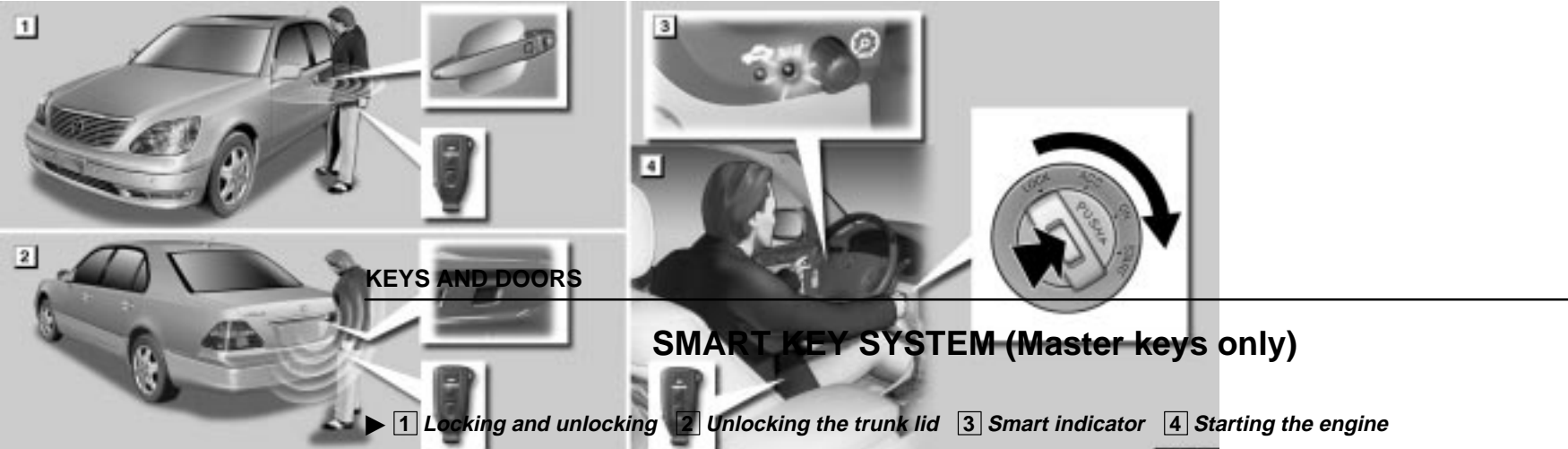

KEYS AND DOORS

SMART KEY SYSTEM (Master keys only)

- **1 Locking and unlocking** **2 Unlocking the trunk lid** **3 Smart indicator** **4 Starting the engine**

By carrying a smart key, which is different from a conventional key that is inserted in the keyholes or ignition switch, you can lock and unlock the doors, unlock the trunk and start the engine.

For locking the doors, see "Locking the doors with the smart key system" on page 25. For unlocking the doors, see "Unlocking the door(s) with smart key system" on page 28. For unlocking the trunk lid, see "Unlocking the trunk lid with smart key system" on page 31. For starting the engine, see "Smart ignition system with steering lock" on page 295.

If the smart key battery is discharged, the smart key system cannot be used. Use the mechanical key integrated into the smart key by inserting it in the door keyhole to lock or unlock doors and into the trunk lid keyhole to unlock the trunk lid. To start the engine, insert the smart key. In order to activate the smart key system, the battery should be replaced. For details, see "Replacing the battery (Type A)" on page 42.

You can deactivate the smart key system by using the cancel switch. In this case, all the functions in the smart key system will be deactivated. For details, see "Deactivating the smart key system" on page 34.

INFORMATION

- *Be sure to take the smart key with you.*
- *In the following cases, the smart key system or wireless remote control feature may not operate properly. (If this happens, use a mechanical key to lock or unlock the doors and trunk lid and a smart key to start the engine.)*
 - ◆ *When facilities issuing strong electromagnetic waves such as TV towers, electric power stations, broadcasting stations are nearby.*
 - ◆ *When you are carrying a smart key together with a mobile communications system such as a two-way radio or cellular phone.*
 - ◆ *When the smart key is in contact with or covered by a metallic object.*
 - ◆ *When another person is operating a wireless remote control function on another vehicle near your vehicle.*
- *If you do not drive your vehicle, store the smart key, keeping it at least 5 m (15 ft.) away from the vehicle.*

Alarms and warning messages

Your Lexus is equipped with alarms inside and outside, as well as warning messages in the multi-information display, that remind you if there is a problem involving the smart key system.

Cases which are expected to happen frequently are shown in the illustrations and the other cases are described in the table. If an alarm or warning message comes on, check to see what the problem is referring to the illustrations and table, and take the appropriate measure.

KEYS AND DOORS



► *When a door is opened and closed with the ignition switch in the “ACC” or “ON” position and with the selector lever in the “P” position, and then the smart key is carried outside of the vehicle.*

Inside alarm: One chime

Outside alarm: 3 beeps

Multi-information display: “Key is not Detected”

See page 98 for details.



► *When you attempted to lock the door(s) with the smart key still in the vehicle or without turning off the ignition switch.*

Outside alarm: One beep (sounds for 2 seconds)

See page 26 and 27 for details.



► *When you lock the smart key in the trunk or attempt to lock a door which is not completely closed.*

Outside alarm: One beep (sounds for 10 seconds)

See page 27 and 32 for details.

KEYS AND DOORS

Inside warning alarm	Outside warning alarm	Multi-information warning message display	Causes	Reference page
Chimes	None	None	You opened a door without turning off the ignition switch.	47
Beep	None	"Shift to P Range"	You opened a door without turning off the ignition switch when the selector lever is in a position other than "P".	99
Beep	Beep	"Shift to P Range" and "Key is not Detected" appear alternately.	You exited and closed a door without turning off the ignition switch when the selector lever is in a position other than "P".	98, 99
One chime	None	"Low Key Battery" (shown for about 5 seconds)	Smart key battery power is insufficient.	99
One chime	None	"Key is not Detected" (shown for about 5 seconds)	The smart key was not in the vehicle when you pushed the ignition switch in the "LOCK" position.	98

Locking the doors with smart key system

The smart key system will lock the doors without being inserted into the door keyhole.

When you exit the vehicle carrying the smart key and push the lock button on the outside door handle with all the doors closed, all the doors will be locked provided that the electronic code in the key corresponds to the registered ID code for the vehicle.

At this time, you will hear one beep and the turn signal lights flash once. However, when you push the lock button on the outside door handle with any door not closed securely, a beep sounds for 10 seconds. (For details, see page 27.)

If outer foot lights are illuminated, you can turn off the lights by pushing the “LOCK” button on the smart key. (For details, see “Outer foot lights” on page 230.)

INFORMATION

- *When locking the doors, be sure to push the lock button on the outside door handle slowly and surely. If you push the button quickly, the doors may not lock.*
- *When opening or closing a door, do not touch the lock button on the outside door handle.*
- *When a wireless key is used to lock the doors and a smart key is left in the effective range of the smart key system in the vehicle, the doors cannot be unlocked using the smart key system. In this case, use the wireless remote function to unlock the doors.*
- *You cannot activate smart unlocking functions within 3 seconds after the smart locking function is activated.*

KEYS AND DOORS

The doors cannot be locked using the smart key system in the following conditions:



► Key reminder alarm

If you push the lock button on the outside door handle with a smart key left in the vehicle, an alarm sounds for 2 seconds and the doors will not lock.

Before you push the lock button, make sure you are carrying the smart key.

INFORMATION

- *Do not put a smart key on the instrument panel, rear package tray or floor, or in the glove box or auxiliary box near the selector lever, which falls outside of the effective range of the smart key system. As the alarm does not sound when a key is left in such a place, you might accidentally lock the doors by pushing the lock button on the outside door handle and be locked out of the vehicle. Be sure to take the smart key with you.*
- *If you have the smart key but bring it very close to the window or outside door handle, the alarm might activate. In this case, keep the smart key a certain distance away from the window or outside door handle and then push the lock button again.*
- *If the smart key is left in the vehicle, attempting to lock the door by pushing in the button located in the inside door handle and holding up the outside door handle will unlock all the doors and activate the alarm for 2 seconds.*



► **Ignition on/off reminder alarm**

If you push the lock button on the outside door handle without turning off the ignition switch, an alarm sounds for 2 seconds and the doors will not lock.

Before you push the lock button, make sure the ignition switch is in the "LOCK" position.



► **Open door warning**

If you push the lock button on the outside door handle while any door is not completely closed, an alarm sounds for 10 seconds and the doors will not lock.

To stop the alarm, close all the doors securely or push the "UNLOCK" button on the smart key.

Before you push the lock button, make sure all the doors are securely closed.

KEYS AND DOORS

Unlocking the door(s) with smart key system



The smart key system can be used to unlock the door(s) without being inserted into the door keyhole.

When you get close to your vehicle (about 1 m (3 ft.) from each outside door handle), and are carrying the smart key, the electronic code emitted from the key is automatically checked to determine if it corresponds to the registered ID code for the vehicle. After this, the outer foot lights come on. (For outer foot lights, see "Outer foot lights" on page 230.) When you take hold of the back side of the outside door handle on the door firmly, it will unlock and the smart indicator light blinks. (You can select the doors to be unlocked. For details, see "Changing the doors to be unlocked" on page 30.)

At this time, two beeps sound and the turn signal lights flash twice. As the door(s) is(are) unlocked, the interior light comes on for 15 seconds if the interior light switch is in the "DOOR" position. However, the interior lights go out when you push the power door lock switch in the lock position or turn the ignition switch to the "ACC" or "ON" position. For further information, see "Interior lights" on page 109.

You have 30 seconds to open a door after operating the smart unlocking function. If a door is not opened by then, all the doors will be automatically locked again.

INFORMATION

- *When unlocking the door(s), be sure to take hold of the back side of the outside door handle firmly as shown in the illustration. Taking hold of the handle with a gloved hand might cause a delay in unlocking or may not unlock.*
- *When you take hold of the handle to unlock the door(s), be sure to confirm that the door(s) has(have) been unlocked. If the emergency flashers flash twice, two beeps sound outside the vehicle and the smart indicator starts blinking, the doors are unlocked. At this time, you can pull the outside door handle to open the door. If you quickly move closer to the vehicle or pull the outside door handle quickly, the doors might not unlock. If you cannot open the door by pulling the outside door handle at this time, push it back to the original position and then pull it out again.*
- *If you bring the smart key very close to the outside door handle, the doors might not unlock.*
- *If another person who is not carrying a smart key takes hold of an outside door handle when you are within the effective range of the smart key system, the door(s) may not unlock.*

- *If a large amount of water is applied to the outside door handle during heavy rain or a car wash, and someone carrying a smart key is near the vehicle, the door(s) might be unlocked. However, if the outside door handle is not pulled out, the doors will lock automatically after about 30 seconds.*

KEYS AND DOORS

Adjusting the volume of beeps

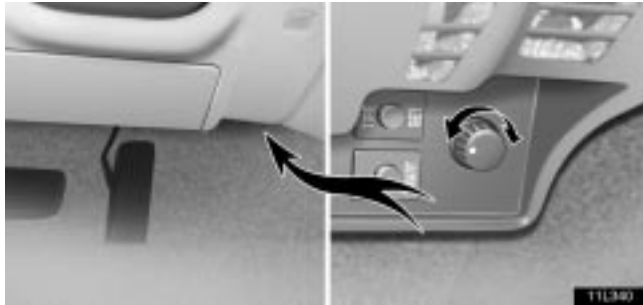

You can adjust the volume of the beeps which confirm the locking or unlocking the doors or remind you when the doors are not completely closed.

Turn the volume adjustment knob counterclockwise to increase the volume or clockwise to decrease it. The beep sound is completely deactivated when you turn the knob clockwise until you hear a click.

INFORMATION

The volume of the smart key system alarm is not adjustable.

Changing the doors to be unlocked

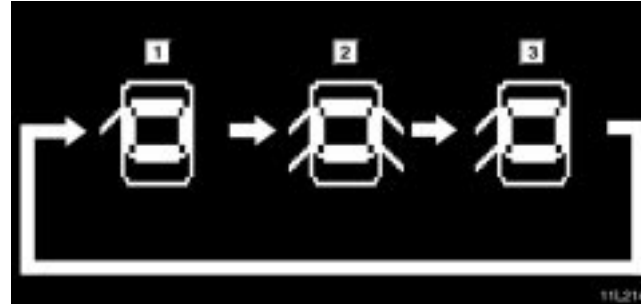

- **1** *Unlocking a single door* **2** *Unlocking all the doors*
3 *Unlocking side doors*

When you push the “LOCK” button together with the “TRUNK” button on the smart key for about 5 seconds with the ignition switch off, you can change the settings for door unlocking.

The settings will change from the door on which you take hold of the outside door handle, to all the doors, to the doors on the side closest to the smart key, and then back to the door on which you take hold of the outside door handle.

After setting, a tone sounds and the multi-information display shows which setting is selected. Outside the vehicle, one beep sounds when a door is set to be unlocked, 2 beeps sound when side doors are set, and 3 beeps sound when all the doors are set.

INFORMATION

If you get in the vehicle from the driver's door using a smart key while the side doors or one door is set to be unlocked, all the smart unlocking controls activated by the smart key will be stopped for security. If you get out of the vehicle from the driver's door carrying the smart key and reaches out of the effective range of the smart key system, unlocking control by the smart key will be possible. However, unlocking control may not be carried out for 5 seconds after you get out from the vehicle. In this case, perform unlocking operation again after 5 seconds.

Unlocking the trunk lid with smart key system

When you push the trunk button on the trunk lid while carrying a smart key, the system allows you to unlock the trunk lid without the key being inserted into the keyhole.

INFORMATION

If you bring the smart key close to the center of the bumper, the trunk lid might not unlock.

KEYS AND DOORS

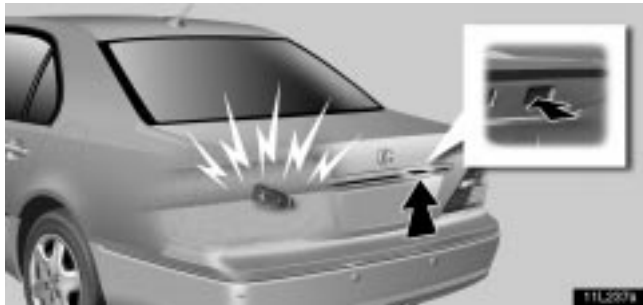

► **Key reminder alarm**

If you lock your key in the trunk, an alarm sounds for 10 seconds to remind you that the key is in the trunk.

To stop the alarm, push the trunk button. At this time, the trunk lid is unlocked. Even after the alarm stops sounding, pushing the trunk button will unlock the trunk lid.

INFORMATION

- *If you close the trunk lid while a smart key is left in the trunk, an alarm should be activated. However, if the key is placed near the spare tire or at the edge of the trunk, or if the key is in a metallic bag, the trunk lid might not be unlocked.*
- *If you accidentally lock a smart key in the trunk, be aware that anyone can unlock the trunk by pushing the trunk button.*
- *Even when the smart key is outside the trunk, an alarm still might be activated if the key is near the trunk. However, if you have the key, there is no problem.*

Battery power saving

When doors are locked, the smart key system transmits electromagnetic waves to the outside of the vehicle at regular intervals. For this reason, the vehicle battery will be discharged if the vehicle is left for a long time. If the key is left within the effective range of the smart key system outside of the vehicle, the key and the vehicle transmit electromagnetic waves periodically.

If these conditions continue for a long time, the battery in the key and vehicle will be discharged and from the sixth day, smart unlocking operations will become slow.

To prevent the batteries from being discharged, the smart key system is automatically deactivated in the following conditions:

- If there is no smart door locking operation for more than 14 days
- If the key is left within the effective range of the smart key system outside of the vehicle for more than 10 minutes

To reactivate the smart key system properly, perform any of the following:

- (a) Press the lock button on the outside door handle while carrying the smart key.
- (b) Perform a wireless remote control operation.
- (c) Insert and turn the key in the keyhole of the door.

INFORMATION

- ***To maintain communication with the vehicle, smart keys (including master keys) use built-in battery power. The battery service life is about 1 to 3 years on average. If battery power becomes insufficient, replace the battery with a new one.***
- ***The smart key continually receives electromagnetic waves, and if it receives strong electromagnetic waves over a period of time, the battery can be drastically run down. Therefore, avoid storing smart keys near any electrical appliances.***

Here is a list of electrical appliances which may have adverse effects on the smart key performance: TVs, personal computers, cellular phone or cordless phone recharger units, electric light stands and fluorescent desk lights

Note that you should always keep such electrical appliances at least 1 m (3 ft.) away from the smart key.

KEYS AND DOORS

Deactivating the smart key system

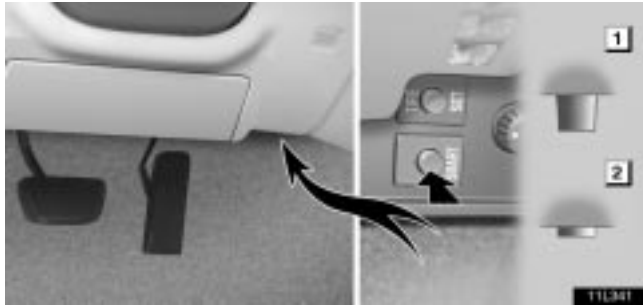

- **1** *Smart key system is on.*
2 *Smart key system is off.*

The cancel switch for this system is located at the bottom of the instrument panel on the driver side. When you push the button, the smart key system will be deactivated. Pushing the button again will reactivate the system.

When the smart key system is deactivated, use a mechanical key or wireless remote control function key to lock and unlock the doors or unlock the trunk lid. To start the engine, insert a smart key into the ignition switch.

If you do not intend to drive your vehicle for a long time, push the cancel switch to deactivate the smart key system.

INFORMATION

The smart key system will be deactivated in the following cases:

- *The smart cancel switch is turned on.*
- *The smart key is inserted into the ignition switch.*
- *The battery of the smart key is discharged. (In this case, the indicator on the smart key does not blink even if you push a button on the key.)*

For vehicles sold in U.S.A.

FCC ID: MOZRO-1TY-1
 CAUTION
Changes or modifications not expressly approved by the party responsible for compliance could void the user's authority to operate the equipment.
FCC ID: PENASAT1 MADE IN JAPAN
This device complies with Part 15 of the FCC Rules. Operation is subject to the following two conditions: (1) This device may not cause harmful interference, and (2) this device must accept any interference received, including interference that may cause undesired operation.

NOTICE

This equipment has been tested and found to comply with the limits for a Class B digital device, pursuant to Part 15 of the FCC Rules. These limits are designed to provide reasonable protection against harmful interference in a residential installation. This equipment generates, uses and can radiate radio frequency energy and, if not installed and used in accordance with the instructions, may cause harmful interference to radio communications. However, there is no guarantee that interference will not occur in a particular installation. If this equipment does cause harmful interference to radio or television reception, which can be determined by turning the equipment off and on, the user is encouraged to try to correct the interference by one or more of the following measures:

- *Reorient or relocate the receiving antenna.*
- *Increase the separation between the equipment and receiver.*
- *Connect the equipment into an outlet on a circuit different from that to which the receiver is connected.*
- *Consult the dealer or an experienced radio/TV technician for help.*

KEYS AND DOORS

For vehicles sold in Canada

This device complies with RSS-210 of Industry Canada.
Operation is subject to the following two conditions:
(1) This device may not cause interference, and (2) this device must accept any interference, including interference that may cause undesired operation of the device.

WIRELESS REMOTE CONTROL*

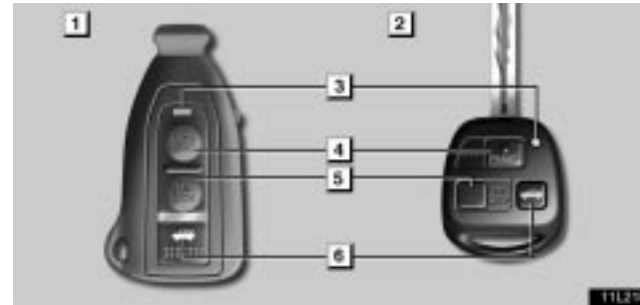

► **1** Type A **2** Type B

3 Indicator light

4 Locking the doors and sounding an alarm

5 Unlocking the doors, and opening the windows and moon roof

6 Unlocking the trunk lid

NOTE:

** This feature can be deactivated as vehicle theft deterrent measure in case of the loss of the wireless remote control function key.*

Ask your Lexus dealer for details.

When you operate any button on the key, push it slowly and surely. At this time, the indicator light on the key grip flashes once.

The operational range of the wireless remote control is approximately 1 m (3 ft.). The effective range may vary with different conditions. To activate the wireless remote control without fail, do it approximately 1 m (3 ft.) from your Lexus.

In the following cases, the battery in the key may be discharged. If this is a case, replace the battery using a special screwdriver. For the key of Type A, we recommend that you have the battery replaced by your Lexus dealer to prevent the key from being damaged.

- The remote control does not work.
- The operational range of wireless remote control becomes extremely short.
- The indicator light on the key is dimmed or does not come on.

For the replacement of the battery of the Type B key, see "Replacing the battery" on page 44. You can also have the battery of the key replaced by your Lexus dealer.

If you lose the wireless function key, contact your Lexus dealer as soon as possible to avoid the possibility of theft, or an accident. (See "If you lose your keys or lock yourself out" on page 432.)

If your vehicle is equipped with smart key system, you can use up to 5 master keys and 3 sub keys for the same vehicle. In case of the vehicle not equipped with smart key system, up to 4 master keys are available. Contact your Lexus dealer for detailed information.

The wireless remote control function key is an electronic component. Observe the following instructions in order not to cause damage to the key.

- Do not leave the wireless remote control function key in places where the temperature becomes high such as on the dashboard.
- Do not disassemble it.
- Avoid knocking it hard against other objects or dropping it.
- Avoid putting it in water.

KEYS AND DOORS

Locking/Unlocking the doors

When you push the “LOCK” button on the key briefly, all the doors can be locked from outside the vehicle.

At this time, you can hear one beep and the turn signal lights flash once.* However, when you push the “LOCK” button with any door not closed securely, the buzzer sounds for 10 seconds.** To stop the buzzer, close all the doors securely or push the “UNLOCK” button. If the key is in the ignition switch, locking cannot be done.

NOTE:

* The turn signal lights can be set not to flash.

** The buzzer can be set not to sound if a door is not closed securely.

Ask your Lexus dealer for details.

If outer foot lights are illuminated, you can turn off the lights by pushing the “LOCK” button on the key. (For details, see “Outer foot lights” on page 230.)

NOTICE

Do not push the “LOCK” button any longer than 2 to 3 seconds. Pushing the button longer activates an alarm. For details, see page 40.

When you push the “UNLOCK” button, the driver’s door is unlocked and outer foot lights come on. Pushing the “UNLOCK” button once again within 3 seconds from the first push, all other doors are also unlocked.*

For outer foot lights, see “Outer foot lights” on page 230.

NOTE:

* The 2-step unlocking function can be changed.

Ask your Lexus dealer for details.

At this time, two beeps sound and the turn signal lights flash twice.* Together with the activation of unlocking, the interior light comes on for 15 seconds if the interior light switch is in “DOOR” position.** However, this function does not work when the ignition switch is in the “ACC” or “ON” position. For further information, see “Interior lights” on page 109.

You have 30 seconds to open a door after using the wireless remote unlock feature.*** If a door is not opened by then, all the doors will be automatically locked again.

NOTE:

* The turn signal lights can be set not to flash.

** The interior light can be set not to come on or the duration of lighting can be changed.

*** The time before automatic re-locking can be changed.

Ask your Lexus dealer for details.

Even if the “LOCK” or “UNLOCK” button is kept pressed in, the locking or unlocking operation is not repeated. Release the button and then push it again.

Adjusting the volume of beeps

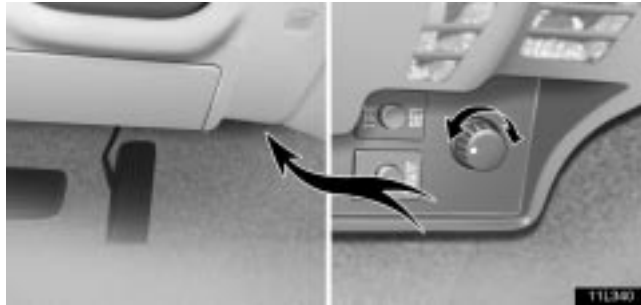

You can adjust the volume of the beeps which confirm the locking or unlocking the doors or remind you when the doors are not completely closed.

Turn the volume adjustment knob counterclockwise to increase the volume or clockwise to decrease it. The beep sound is completely deactivated when you turn the knob clockwise until you hear a click.

INFORMATION

The volume of the smart key system alarm is not adjustable.

Unlocking the trunk lid



▶ **1** Type A **2** Type B

When you keep the button pushed for about 1 second, you can unlock the trunk lid.* One beep sounds.

This function does not work when the ignition switch is in the "ON" position.

NOTE:

** The operation method can be changed. Ask your Lexus dealer for details.*

KEYS AND DOORS

Sounding an alarm*

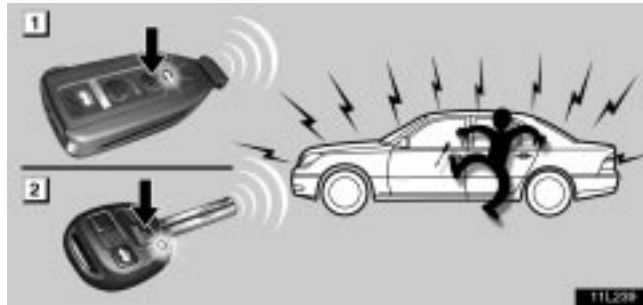

▶ **1** Type A **2** Type B

When you keep the “PANIC” button pushed for about 2 to 3 seconds, an alarm sounds to deter any person trying to break into or damage your vehicle.

If you want to stop the alarm, push any button.

This function does not work when the ignition switch is in the “ON” position.

NOTE:

* The alarm can be set not to sound.
Ask your Lexus dealer for details.

Operating the windows and moon roof

The windows and moon roof can be operated using a wireless remote control key from outside the vehicle.*

NOTE:

* The windows can be deactivated. The moon roof can be set to slide open or tilt up or deactivated.
Ask your Lexus dealer for details.



▶ **1** Type A **2** Type B

Push the “UNLOCK” button until the windows and moon roof start to move. At this time one beep sounds. When you release the button, the windows and moon roof stop operating.

This function will work even with the window lock switch pressed in.

For vehicles sold in U.S.A.

FCC ID: HYQ12BBK
 CAUTION
Changes or modifications not expressly approved by the party responsible for compliance could void the user's authority to operate the equipment.
This device complies with Part 15 of the FCC Rules. Operation is subject to the following two conditions: (1) This device may not cause harmful interference, and (2) this device must accept any interference received, including interference that may cause undesired operation.

NOTICE

This equipment has been tested and found to comply with the limits for a Class B digital device, pursuant to Part 15 of the FCC Rules. These limits are designed to provide reasonable protection against harmful interference in a residential installation. This equipment generates, uses and can radiate radio frequency energy and, if not installed and used in accordance with the instructions, may cause harmful interference to radio communications. However, there is no guarantee that interference will not occur in a particular installation. If this equipment does cause harmful interference to radio or television reception, which can be determined by turning the equipment off and on, the user is encouraged to try to correct the interference by one or more of the following measures:

- *Reorient or relocate the receiving antenna.*
- *Increase the separation between the equipment and receiver.*
- *Connect the equipment into an outlet on a circuit different from that to which the receiver is connected.*
- *Consult the dealer or an experienced radio/TV technician for help.*

KEYS AND DOORS

For vehicles sold in Canada

This device complies with RSS-210 of Industry Canada.
Operation is subject to the following two conditions:
(1) This device may not cause interference, and (2) this device must accept any interference, including interference that may cause undesired operation of the device.

Replacing the battery (Type A)

We recommend that you have the battery replaced by your Lexus dealer to prevent the key from being damaged.

When you replace the battery, prepare a lithium battery CR2032 or equivalent and a special screwdriver.

 **CAUTION**

Special care should be taken to prevent small children from swallowing the removed battery or components.

NOTICE

- *Replace only with the same or equivalent type recommended by a Lexus dealer.*
- *Dispose of used batteries according to the local laws.*

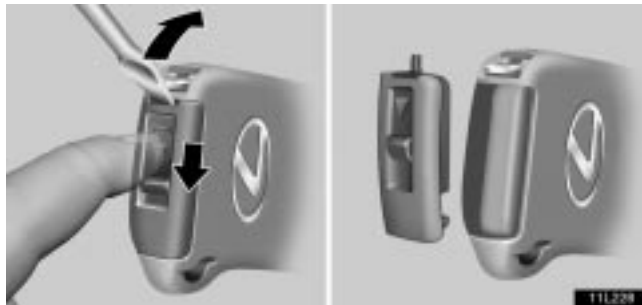

1. While sliding the lock switch using your finger, remove the cover on the side of the key using a special screwdriver.

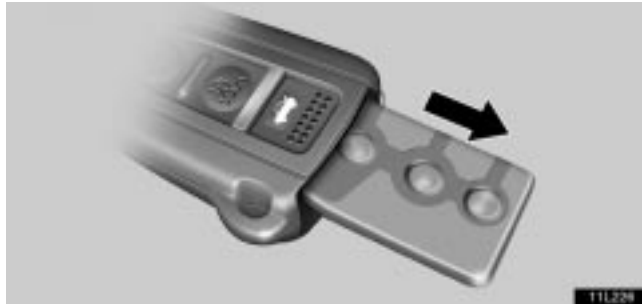

2. Remove the module from the main frame.

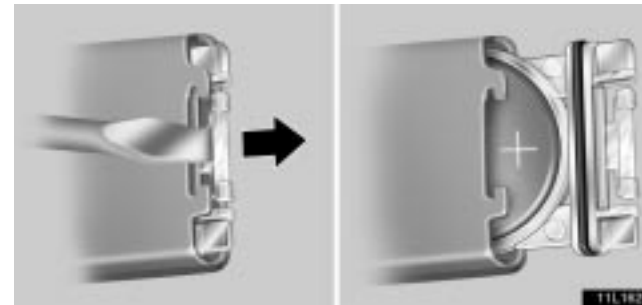

3. Pull the battery base out of the module using a special screwdriver.



4. Remove the battery base from the module.

5. Take out the discharged battery and put a new battery with the positive side up.

KEYS AND DOORS

NOTICE

- **Make sure the positive side and negative side of the battery are faced correctly.**
- **Do not replace the battery with wet hands. Water may cause unexpected rust.**
- **Do not touch or move any components inside the transmitter, or it may interfere with proper operation.**
- **Be careful not to bend the electrode when inserting the battery and that dust or oils do not adhere to the inside of the module.**

6. Install the battery base into the module.

NOTICE

Take care not to damage or bend the battery base when installing.

7. Install the module into the main frame.

8. Install the cover back on the side of the key by sliding it using your finger.

9. When pushing any switch on the wireless key, make sure the indicator light comes on.

Replacing the battery (Type B)

When you replace the battery, prepare a lithium battery CR1616 or equivalent and a special screwdriver.

CAUTION

Special care should be taken to prevent small children from swallowing the removed battery or components.

NOTICE

- **When replacing the battery, be careful not to lose the components, screws and O-ring.**
- **Replace only with the same or equivalent type recommended by a Lexus dealer.**
- **Dispose of used batteries according to the local laws.**



1. Remove the screw, and then the cover while pushing it in the arrow direction.



2. Remove the module from the key frame.

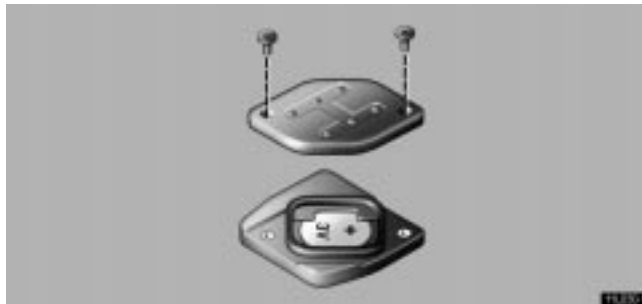

3. Remove the 2 screws to take out the lid of the module.

4. Take out the discharged battery and put a new battery with the positive side up.

NOTICE

- *Make sure the positive side and negative side of the battery are faced correctly.*
- *Do not replace the battery with wet hands. Water may cause unexpected rust.*
- *Do not touch or move any components inside the transmitter, or it may interfere with proper operation.*
- *Be careful not to bend the electrode when inserting the battery and that dust or oils do not adhere to the inside of the module.*
- *Take care not to lose the screws and O-ring.*

5. Install the lid with the 2 screws.

NOTICE

Take care not to damage or bend the O-ring when installing.

6. Install the module into the key frame and secure the cover with the screw.

7. When pushing any switch on the wireless key, make sure the indicator light comes on.

KEYS AND DOORS

DOORS

See page 25 for locking the doors with smart key system and page 28 for unlocking them with smart key system.

Locking with key

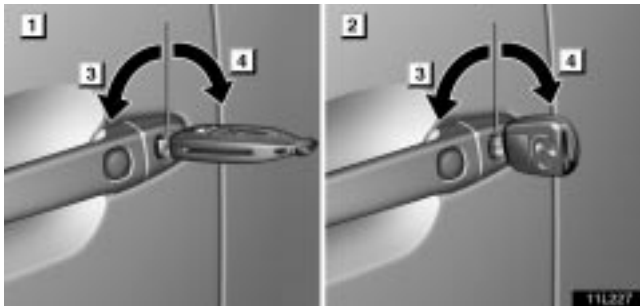

► **1** Type A **2** Type B **3** Lock **4** Unlock

Turn the key towards the front of the vehicle to lock and towards the back to unlock.

The doors lock and unlock simultaneously with the driver's door. Turning the key once will unlock the driver's door and twice in succession will unlock all doors simultaneously.*

NOTE:

* The 2-step unlocking function can be changed.
Ask your Lexus dealer for details.

If a wrong key is used, the key cylinder rotates freely to isolate inside mechanism. So, door locking is protected from thieves.

The windows and moon roof can be opened and closed from outside the vehicle using the key. For details, see "Power window switches" on page 64 and "Moon roof" on page 145.

Locking with inside lock button

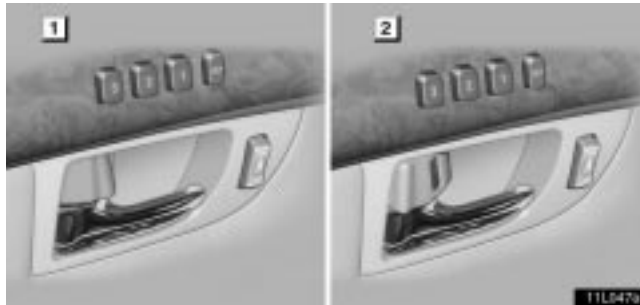

► **1** Lock **2** Unlock

Push in the lock button to lock and unlock the door.

The front doors can be opened by pulling the inside handles even if the lock buttons are in the locked position.

! CAUTION

Do not pull the inside handle of the front doors while driving. The doors will open and an accident may occur. Lexus strongly recommends that all children be placed in the rear seat of the vehicle.

Closing the door with the lock button pushed in will also lock the door. Be careful not to lock your keys in the vehicle. Doors cannot be locked when either front door is open and the key is in the ignition. For the vehicles equipped with the smart key system, if you open the driver's door to get out from the vehicle without returning the ignition switch to the "LOCK" position, chimes sound and the door will not lock when closing the door.

If the vehicle is subjected to a severe frontal, rear or side impact with the ignition switch turned to the "ON" position, all doors will unlock automatically after a few seconds.

! CAUTION

Before driving, make sure the doors are closed and locked, especially when small children are in the vehicle. Along with the proper use of seat belts, locking the doors helps prevent the driver and passengers from being thrown out from the vehicle during an accident. It also helps prevent the doors from being opened unintentionally.

KEYS AND DOORS

Locking with power door lock switch



► **1** Lock **2** Unlock

To lock all the doors simultaneously, push the power door lock switch down on the front side. Pushing down on the rear side will unlock them.

When you push the power door lock switch on the rear side to unlock the doors to allow a passenger to get in, the outer foot lights come on. To turn off the lights, push the power door lock switch on the front side. (For details, see "Outer foot lights" on page 230.)

The same switch is also found on the front passenger's side. However, pushing this switch will neither turn on nor off the outer foot lights.

Auto door locking function*: All the doors will lock automatically when the selector lever is moved out of "P" position. This auto door locking function is operable if any doors are unlocked while the ignition switch is in the "ON" position.

NOTE:

** This setting can be changed as in the following:*

- *All the doors are locked automatically at 20 km/h (12 mph) or higher vehicle speed. However, if any door is unlocked during driving, this auto locking function does not operate until the unlocked door is once opened.*
- *When the selector lever is moved out of "P" position and the brake pedal is held off your foot, this function is enabled.*

Ask your Lexus dealer for details.

Door closer (some models)

If any door is closed but does not latch shut, it automatically closes completely. This system is equipped on all the doors and will activate regardless of the ignition switch position.

Pulling the door handle will cancel the door closer, allowing you to open the door which is about to close. However, pulling the door handle of the rear door which is locked with the child protector will not cancel the door closer.

⚠ CAUTION

- Careful attention is needed so as not to get your fingers trapped as the door automatically closes when the door has not been fully closed.
- Never allow a child to operate the door.

Locking with rear door child-protector



► **1 Lock 2 Unlock**

Whenever small children are in the vehicle, lock the rear door so that it does not open by the inside door handle. To do this, move the knob to the “LOCK” position as shown and then close the door.

KEYS AND DOORS

THEFT DETERRENT SYSTEM



To deter theft of the vehicle, this system is designed to sound an alarm if any of the doors, trunk or hood is forcibly unlocked or opened or the battery terminal is disconnected and then reconnected while the vehicle is locked.

The alarm blows the horn intermittently, flashes the headlights, tail lights, turn signal lights and other exterior lights. When the interior light switch is in the "DOOR" position, the interior lights also turn on.

After the alarm is activated, when you unlock any door or the trunk using an ignition key or wireless remote control or smart key system, the tail lights turn on for about 2 seconds to inform you that the system was activated.



► Security indicator light

Setting the system

In the case of the smart key system:

1. Turn the ignition switch to the "LOCK" position.

The engine immobilizer system causes the indicator light to flash.

2. Close and lock all the doors, trunk and hood using an ignition key or wireless remote control or smart key system.

If you lock them with wireless remote control or smart key system, the turn signals flash once.*

NOTE:

* The turn signals can be set not to flash.

Ask your Lexus dealer for details.

The flashing indicator light will stay on when all the doors, trunk and hood are closed and locked.

3. After 30 seconds, the indicator starts flashing and the system is set.

After the system is set, when you close the trunk which is opened with an ignition key or wireless remote control or smart key system, the system is set again. However, this function operates only when the door is not unlocked during which the trunk is opened and closed.

In case of the ignition switch with the key inserted:

1. Turn the ignition key to the “LOCK” position and remove it.

The engine immobilizer system causes the indicator light to flash.

2. Close and lock all the doors, trunk and hood using an ignition key or wireless remote control or smart key system.

If you lock them with wireless remote control or smart key system, the turn signals flash once.*

NOTE:

** The turn signals can be set not to flash.*

Ask your Lexus dealer for details.

The flashing indicator light will stay on when all the doors, trunk and hood are closed and locked.

3. After 30 seconds, the indicator starts flashing and the system is set.

After the system is set, when you close the trunk which is opened with an ignition key or wireless remote control or smart key system, the system is set again. However, this function operates only when the door is not unlocked during which the trunk is opened and closed.

Cancelling the system

When you unlock any door using an ignition key, wireless remote control or smart key system, the system is cancelled.

If you unlock any door with the wireless remote control or smart key system, the turn signals flash twice.*

NOTE:

** The turn signals can be set not to flash.*

Ask your Lexus dealer for details.

KEYS AND DOORS

Activating the system

The alarm sounds for 60 seconds if any of the following are operated:

- Unlocking any door or trunk without using an ignition key, wireless remote control or smart key system.
- Opening the hood forcibly.
- Reconnecting the battery.
- Hot-wiring the ignition.

If any door is unlocked and the ignition key is not in the ignition switch during the alarm sounding, its door is automatically locked.

To stop the alarm: Use either of the following methods.

- Unlock the door or trunk using an ignition key or wireless remote control or smart key system.
- Turn the ignition switch on.

Testing the system

1. **Open all the windows.**
2. **Set the system as described above.**

The doors should be locked with an ignition key, wireless remote control or smart key system. Be sure to wait until the indicator light starts flashing.

3. **Unlock one of the doors from the inside through one of the opened windows.**

The system should activate the alarm.

4. **Unlock any of the doors with an ignition key, wireless remote control or smart key system to cancel the system.**

5. **Repeat this operation for the other doors, trunk and hood.**

When testing the hood, also check that the system is activated when the battery terminal is disconnected and then reconnected.

If the system does not work properly, have it checked by your Lexus dealer.

NOTICE

When disconnecting the battery, be sure to cancel the theft deterrent system. Otherwise, the system could activate an alarm and lock the unlocked door(s) automatically.

SECTION 1-2

INSTRUMENTS AND CONTROLS

Switches

Headlight switch	54
Headlight dimmer and turn signal switch	57
Fog light switch	58
Windshield wiper and washer switch	58
Headlight cleaner switch	62
Rear window and outside rear view mirror defogger switch	63
Power window switches	64
Emergency flasher switch	68
Seat heater switches	69
Climate control seat switches	71
Refreshing rear seat switches	76

SWITCHES

HEADLIGHT SWITCH

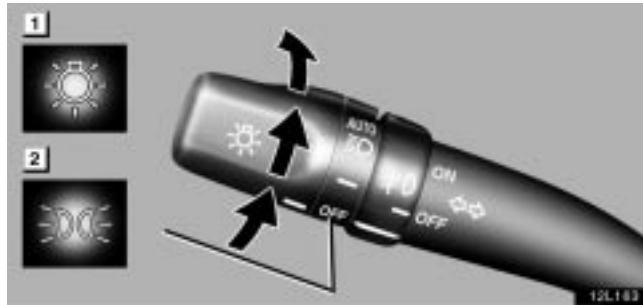

► **1 U.S.A.** **2 Canada**

To turn the lights on, twist the knob on the end of the lever.

FIRST CLICKSTOP: Only the parking, tail, license plate, side marker and instrument panel lights turn on.

SECOND CLICKSTOP: Headlights also turn on.

THIRD CLICKSTOP (“AUTO”): The headlights and all other lights automatically turn on depending on the darkness of the surroundings.*

NOTE:

* *The operating condition or sensitivity can be changed. Ask your Lexus dealer for details.*

Vehicles sold in U.S.A.: When the headlights are on, the headlight indicator lights up in the instrument cluster.

Vehicles sold in Canada: When the tail lights are on, the tail light indicator lights up in the instrument cluster.

With the knob in the “AUTO” position, there may be a case that the headlights do not turn on immediately, even when the vehicle enters a dark place such as a tunnel or parking lot according to lighting conditions. In this case, we recommend you to twist the knob manually to the second clickstop to turn on the headlights immediately.

When the headlight switch is turned to the first or second clickstop, the brightness of the instrument cluster will be reduced slightly unless the instrument panel light control knob is turned fully on.

However, the brightness of the instrument cluster will not be reduced in daytime even when the headlight switch is turned to first or second clickstop.



The automatic light control sensor is on the top center of the instrument panel.

Do not place anything on the instrument panel, and/or do not affix anything on the windshield to block this sensor.

When you turn on the headlights, the lights automatically turn off about 30 seconds after any of the doors is opened and closed with the ignition switch turned to the "ACC" or "LOCK" position.* To turn them on again, turn the ignition switch to the "ON" position, or turn the headlight switch off and then twist the knob until the first or second clickstop. If you are going to park for over one week, make sure the headlight switch is off.

When the headlight switch is on with all the doors locked and the trunk closed, pushing the "LOCK" button on the wireless remote control key turns off the headlights.

NOTE:

* The time before turning off the lights can be changed. Ask your Lexus dealer for details.

Daytime Running Light System

The headlights turn on at reduced intensity when the parking brake is released with the engine started, even with the light switch in the "OFF" position. They will not go off until the ignition switch is turned off.

To turn on the other exterior lights and instrument panel lights, twist the knob to the first clickstop.

Twist the knob to the second clickstop to turn on the headlights to full intensity for driving at night.

When setting the knob to the third clickstop ("AUTO"), the headlights will automatically adjust to full intensity and/or turn on the other lights depending on the darkness of the surroundings. Likewise, as the surroundings become brighter, the headlights will turn to reduced intensity, ultimately turning off the other lights.

NOTICE

To prevent the battery from being discharged, do not leave the lights on longer than necessary when the engine is not running.

SWITCHES

Automatic headlight leveling system

The headlight beam level is always maintained automatically at the proper level in all loading conditions so that your headlights do not dazzle other road users.

If the system fails, the “AFS OFF” indicator light in the instrument cluster will flash. If this occurs, have your vehicle checked by your Lexus dealer.

Adaptive front-lighting system

Adaptive front-lighting system (AFS) provides the proper headlight beam level according to the current driving conditions. This system moves the headlight beam left or right according to the turning angle of the steering wheel. The synergy of this system and the automatic headlight leveling system improves visibility at the intersections and curves.

The system operates when the vehicle speed increases above 10 km/h (6 mph), and stops when the vehicle speed drops below 10 km/h (6 mph).

The system can operate within the limited range of the steering wheel turning angle.



- ▶ **1 Adaptive front-lighting system cancel switch**
- 2 Inoperative**
- 3 Operative**

If you do not want to activate the system, push in the switch to cancel the system. To turn it on, push it again.

When the system is canceled, the “AFS OFF” indicator lights up in the instrument cluster.

If the system fails, the indicator light in the instrument cluster will flash. If this occurs, have your vehicle checked by your Lexus dealer.

HEADLIGHT DIMMER AND TURN SIGNAL SWITCH



For high beam, push the lever forward. Pull it back for low beam. For the headlight flasher, pull it further back.

A blue light in the instrument cluster indicates high beam or headlight flasher is on.

The headlight flasher works even when the headlight switch is off.



For signaling turns, move the lever up or down in the conventional manner.

The ignition switch must be in the "ON" position.

The turn signal is self-cancelling after a turn, but after a lane change, you may have to cancel it by hand. You can also signal a lane change by moving the turn signal lever partway and holding it there.

If the green light in the instrument cluster flashes faster than normal, it indicates that the front or rear turn signal bulb has burned out. If this indicator light does not come on, the fuse or the indicator light itself has probably failed.

SWITCHES

FOG LIGHT SWITCH



To turn on the fog lights, twist the band of the headlight lever to the "ON" position. They will come on only when the headlights are on low beam.

When the fog lights are on, the indicator lights up in the instrument cluster.

WINDSHIELD WIPER AND WASHER SWITCH

Intermittent operation type



► **1** Interval adjuster **2** Washer on

To turn the wipers on, move the lever down until you reach the desired speed setting.

The ignition switch must be in the "ON" position.

There are 3 settings:

"INT" position: Intermittent operation

"LO" position: Low speed operation

"HI" position: High speed operation

Twist the interval adjuster upward to increase the wiping time interval between sweeps, and downward to decrease it.

SWITCHES

The wiper lever must be in the "INT" position.

The time interval between sweeps is shortened when the vehicle speed increases. When the vehicle speed reaches more than about 20 km/h (12 mph) with the interval adjuster in "F" position, the time interval becomes the shortest 1.5 seconds.

If you stop the vehicle with the wiper switch in the "LO" position, the wiper speed automatically changes from low speed to intermittent operation speed.* This function does not work when the interval adjuster is in the "F" position.

NOTE:

** This feature can be deactivated.*

Ask your Lexus dealer for details.

For mist wiper operations (a single wipe), pull the lever toward you and release it.

To make the washer squirt, push the button on the end of the lever.

If the wiper lever is in the "OFF" position, the wipers will automatically make 3 wipes and then a single wipe later to sweep the windshield completely.* The interval between the 3 wipes and the last wipe will depend on the vehicle speed. The last sweep does not happen if the vehicle speed exceeds about 170 km/h (106 mph).

NOTE:

** The last single wipe can be deactivated.*

Ask your Lexus dealer for details.

The warning message "Low Washer Fluid" is displayed in the multi-information display when the fluid level in the tank becomes very low. For information on adding washer fluid, see "Adding washer fluid" on page 512.

In cold weather, warm the windshield with the defroster before using the washer. This will help prevent icing, which could block your vision.

The rear window and outside rear view mirror defogger automatically turns on when you operate the wipers.

NOTICE

Do not operate the wipers if the windshield is dry. It may scratch the glass.

SWITCHES

Raindrop detection type

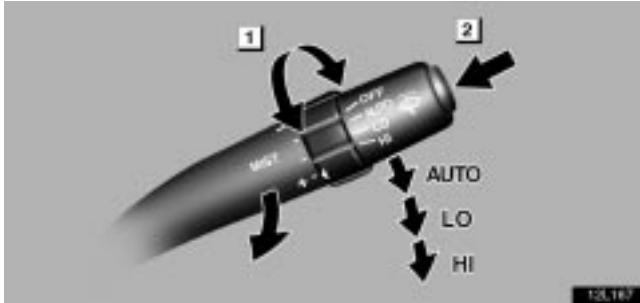

► **1** Automatic control adjuster **2** Washer on

To turn the wipers on, move the lever down until you reach the desired speed setting.

The ignition switch must be in the "ON" position.

There are 3 settings:

"**AUTO**" position — Automatic operation

"**LO**" position — Low speed operation

"**HI**" position — High speed operation

Automatic operation

The wiper speed is determined by the vehicle speed and the amount of raindrops and sunlight detected by the automatic wiper control sensor.

Twist the automatic control adjuster in the "-" direction to lower the sensitivity, and the "+" direction to boost the sensitivity.



The sensor is on the inside of the windshield as shown above.

With the ignition switch turned off, if the windshield sensor is touched by reason of cleaning the windshield or for any other reason, either of the following operations may cause automatic wiper activation.

- Turning the ignition switch on with the wiper lever in the “AUTO” position.
- Turning the ignition switch on and move the wiper lever down in the “AUTO” position.

Even with the wiper lever in the “AUTO” position, the system will switch to intermittent operations if the system malfunctions.

The system will turn off if the windshield gets extremely hot (at more than 80°C or 176°F) or cold (at less than -10°C or 14°F).

When the ignition switch is turned off with the wiper lever in the “AUTO” position, and then the ignition switch is turned on again, the automatic operation may not work even if raindrops are on the windshield.

In this case, move the lever to another position and return it to the “AUTO” position again.

**CAUTION**

Be careful not to get your fingers caught between the wipers and windshield.

When the wiper lever is in the “AUTO” position with the ignition switch on, the wipers could operate automatically in the following cases:

- **If you touch the upper center of the windshield adjacent to the sensor.**
- **If you wipe the upper center of the windshield (adjacent to which the sensor is located) with a towel.**
- **If the windshield vibrates.**
- **If you touch the sensor.**

SWITCHES

For mist wiper operations (a single wipe), pull the lever toward you and release it.

To make the washer squirt, push the button on the end of the lever.

If the wiper lever is in the “OFF” position, the wipers will automatically make 3 wipes and then a single wipe later to sweep the windshield completely.* The interval between the 3 wipes and the last wipe will depend on the vehicle speed. The last sweep does not happen if the vehicle speed exceeds about 170 km/h (106 mph).

NOTE:

* The last single wipe can be deactivated.

Ask your Lexus dealer for details.

The warning message “Low Washer Fluid” is displayed in the multi-information display when the fluid level in the tank becomes very low. For information on adding washer fluid, see “Adding washer fluid” on page 512.

In cold weather, warm the windshield with the defroster before using the washer. This will help prevent icing, which could block your vision.

The rear window and outside rear view mirror defogger automatically turns on when you operate the wipers.

NOTICE

Do not operate the wipers if the windshield is dry. It may scratch the glass.

HEADLIGHT CLEANER SWITCH



To spray fluid on the headlights, push the switch with the headlights on.

The ignition switch must be in the “ON” position.

The warning message “Low Washer Fluid” is displayed in the multi-information display when the fluid level in the tank becomes very low. For information on adding washer fluid, see “Adding washer fluid” on page 512.

NOTICE

Do not turn the headlight cleaner on with the washer fluid tank empty. It may cause the cleaner motor to overheat.

REAR WINDOW AND OUTSIDE REAR VIEW MIRROR DEFOGGER SWITCH



► *Vehicles with navigation system*

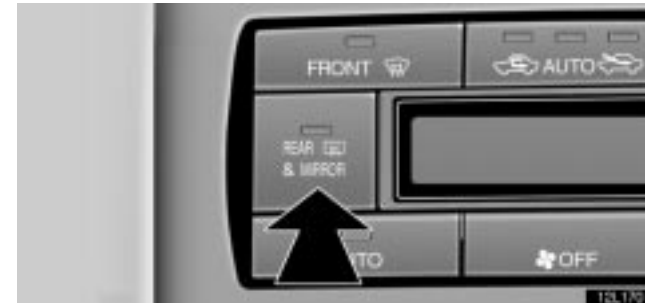

► *Vehicles with rear air conditioning*



► *Vehicles without rear air conditioning*

To turn the electric rear window defogger on, push the switch.

The ignition switch must be in the "ON" position.

SWITCHES

The thin heater wires on the inside of the rear window and the heater panels in the outside rear view mirrors will quickly clear the surface. Keep your hands off the mirror faces when the switch is on. An indicator light is on when the defogger is operating.

The system will automatically shut off when the defogger has operated about 15 minutes.



CAUTION

Since the mirror surfaces can get hot, do not touch them when the switch is on.

If further defrosting or defogging is desired, simply actuate the switch again. When the surface has cleared, push the switch once again to turn the defogger off. Continuous use may cause the battery to discharge, especially during stop- and-go driving. The defogger is not designed to dry rain water or to melt snow.

If the outside rear view mirrors are heavily coated with ice, use a spray de-icer before operating the switch.

NOTICE

- **When cleaning the inside of the rear window, be careful not to scratch or damage the heater wires or connectors.**
- **To prevent the battery from being discharged, turn the switch off when the engine is not running.**

POWER WINDOW SWITCHES



- ▶ **1 For driver's window**
- 2 For front passenger's window**
- 3 For left rear window**
- 4 For right rear window**

To raise or lower the windows, use the switch on each door. The passengers' windows can also be controlled by the switches on the driver's door.

The power windows work when the ignition switch is in the "ON" position.

Key off operation: Even if the ignition switch is turned to the "ACC" or "LOCK" position with all the doors closed, the window can be operated until any of the doors is opened (or for about 45 seconds).



Operating the switches

To lower the window, push the switch halfway down. Pull it up to raise the window. The window glass moves as long as the switch is operated.

Automatic operation: To fully raise or lower the window automatically, pull the switch fully up or push it fully down.

To stop the window partway, lightly push or pull the switch in the opposite direction and then release it.

Operating the window lock switch



► *Indicator light*

With the window lock switch pressed in, only the driver's window can be raised or lowered.

The indicator lights on the switches tell you which of the switches can be operated.

Even with the window lock switch pressed in, the windows will be opened from outside the vehicle using an ignition key or wireless remote control.

SWITCHES

Operating the windows from outside the vehicle

The windows can be operated using the key.*

NOTE:

* This feature can be deactivated.
Ask your Lexus dealer for details.

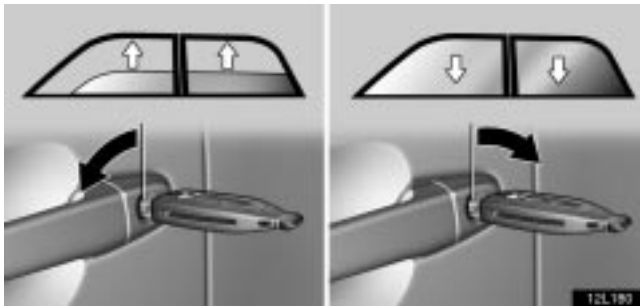

► **Type A**

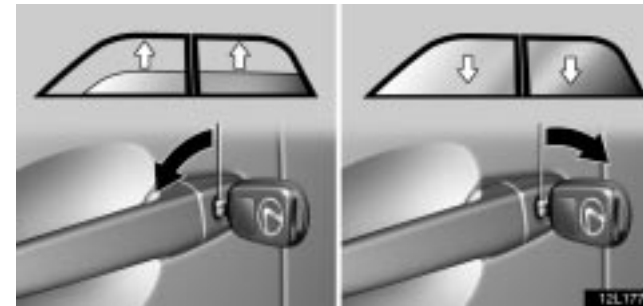

► **Type B**

Insert the key into the keyhole on the driver's door.

To close the windows: Turn the key in the locking direction and hold it.

After the door is locked, the windows begin to close. To stop in the middle, return the key.

To open the windows: Turn the key in the unlocking direction and hold it.

After the door is unlocked, the windows begin to open. To stop in the middle, return the key.

This function will work even with the window lock switch pressed in.

The windows also can be opened using the wireless remote control. For details, see page 40.

Jam protection function

During automatic raising operation, key off raising operation or raising operation using the key from the outside, the window stops and is lowered if something gets caught between the window and window frame.

If the window receives a strong impact, this function may work even if nothing is caught.

 **CAUTION**

To avoid serious personal injury, you must do the following.

- Before you close the power windows, always make sure there is nobody around the power windows. You must also make sure the heads, hands and other parts of the bodies of all occupants are kept completely inside the vehicle. If someone's neck, head or hands get caught in a closing window, it could result in a serious injury. When anyone closes the power windows, make sure he or she operates the windows safely.
- When small children are in the vehicle, never let them use the power window switches without supervision. Use the window lock switch to prevent them from making unexpected use of the switches.
- Be sure to remove the ignition key or turn the ignition switch to the "LOCK" position when you leave your vehicle.

- Never leave anyone (particularly a small child) alone in your vehicle, especially with the ignition key still inserted or with the ignition switch in a position other than "LOCK". Otherwise, he/she could use the power window switches and get trapped in a window. Unattended person (particularly a small child) can be involved in a serious accident.
- Never try jamming any part of your body to activate the jam protection function intentionally.
- The jam protection function may not work if something gets caught just before the window is fully closed.

SWITCHES

EMERGENCY FLASHER SWITCH



► Vehicles with navigation system

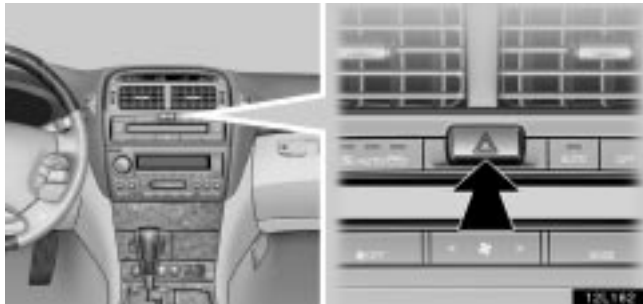

► Vehicles without navigation system

To turn on the emergency flashers, push the switch. To turn them off, push the switch again.

All the turn signal lights will flash. The emergency flashers will work with the engine running or off and with or without the ignition key.

Turn on the emergency flashers to warn other drivers if you must stop your vehicle where it might be a traffic hazard.

Always pull your vehicle as far off the road as possible.

The turn signal light switch will not work when the emergency flashers are in operation.

NOTICE

To prevent the battery from being discharged, do not leave the switch on longer than necessary when the engine is not running.

SEAT HEATER SWITCHES

Front seat heater

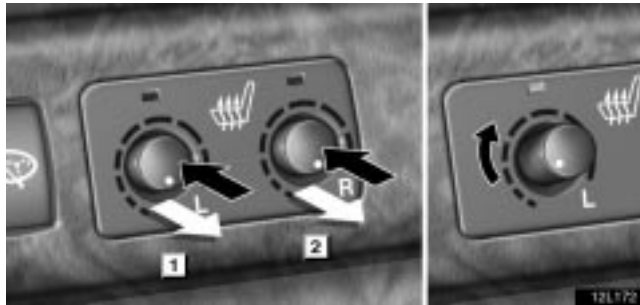

1 For driver's seat **2** For front passenger's seat

The front seat heater has two switches: one marked “L” (for the left seat) and the other marked “R” (for the right seat).

The ignition switch must be in the “ON” position.

To use the seat heater:

1. Push the knob to pop it out.
2. Turn the knob clockwise. The indicator light turns on.
3. Adjust the knob to the desired temperature.

To turn off the seat heater, turn the knob counterclockwise until it stops.

Push the knob into the recessed position when not in use.

Rear seat heater

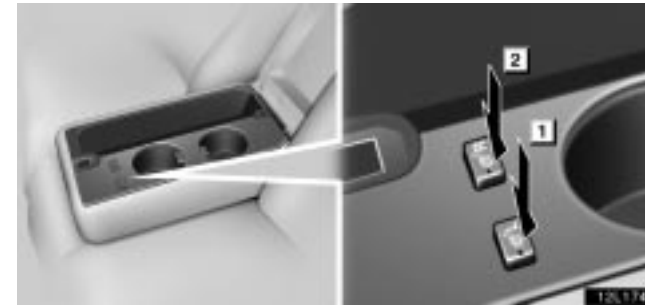

► *Vehicles without rear power seats*

1 For left seat **2** For right seat

The rear seat heater has two switches: one marked “L” (for the left seat) and the other marked “R” (for the right seat). Push these switches to turn the respective seat heaters on, and push the switches again to turn them off.

The ignition switch must be in the “ON” position.

The indicator light turns on when the seat heater is operating.

SWITCHES



CAUTION

Occupants must use caution when operating the seat heater because they may experience minor burns even at low temperatures. Use extra caution for;

- Babies, small children, elderly persons, sick persons or persons with physical disabilities
- Persons who have delicate skin
- Persons who are exhausted
- Persons who have taken alcohol or drugs which induce sleep (sleeping drug, cold remedy, etc.).

To prevent the seat from overheating, do not use the seat heater with a blanket, cushion, or other insulating objects which cover the seat.

NOTICE

- *Do not put unevenly weighted objects on the seat and do not stick sharp objects (needles, nails, etc.) into the seat.*
- *When cleaning the seats, do not use organic substances (paint thinner, benzine, alcohol, gasoline, etc.). They may damage the heater and seat surface.*
- *To prevent the battery from being discharged, turn the switches off when the engine is not running.*

CLIMATE CONTROL SEAT SWITCHES

The climate control seat feeds air at the temperature you desire from the seat surface, for the comfort of the occupants.

Front climate control seats

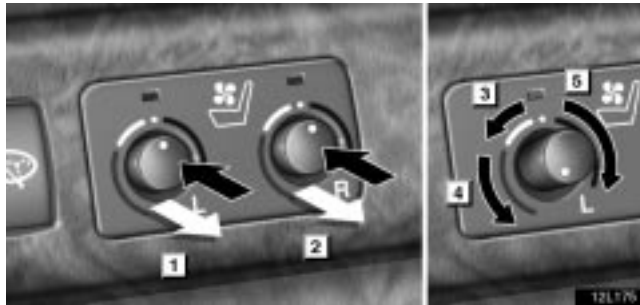

- **1** For driver's seat **2** For front passenger's seat
3 Air at room temperature **4** Cool air **5** Warm air

The front climate control seat has two switches: one marked "L" (for the front left seat) and the other marked "R" (for the front right seat).

The ignition switch must be in the "ON" position.

The front climate control seat has three modes: air at room temperature, cool air and warm air.

To use the front seat climate control, push the knob to pop it out and then turn the knob. The indicator light comes on.

To feed air at room temperature, turn the knob to the gray zone.

To feed cool air, turn the knob counterclockwise and set the knob in the blue zone. Three setting levels are available.

To feed warm air, turn the knob clockwise and set the knob in the red zone. Three setting levels are available.

After the switch is turned on, it takes several minutes until you feel warm or cool.

To disable this function, turn the knob to the center position (the gray dot). The indicator light goes off.

Push the knob into the recessed position when not in use.

SWITCHES

Rear climate control seats

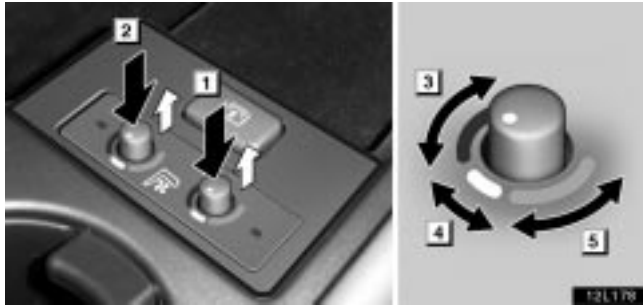

- **1** For left seat **2** For right seat
3 Warm air **4** Air at room temperature **5** Cool air

The rear climate control switches are located in the rear armrest.

The rear climate control seat has two switches: one marked “L” (for the rear left seat) and the other marked “R” (for the rear right seat).

The ignition switch must be in the “ON” position.

The rear climate control seat has three modes: air at room temperature, cool air and warm air.

To use the rear seat climate control, push the knob and turn the knob. The indicator light comes on.

To feed air at room temperature, turn the knob to the gray zone.

To feed cool air, turn the knob counterclockwise and set the knob in the blue zone. Three setting levels are available.

To feed warm air, turn the knob clockwise and set the knob in the red zone. Three setting levels are available. When you push and turn the knob to the red zone, the seat heater turns on first and then the rear climate control operates to feed warm air.

After the switch is turned on, it takes several minutes until you feel warm or cool.

To disable this function, push the knob again. The indicator light goes off.

If you turn off the ignition switch without turning off the rear climate control seat, the rear climate control seat does not turn on with the ignition on.

 **CAUTION**

Use caution when operating the climate control seat. The occupants listed below may experience minor burns even at low temperatures from warm air.

- Babies, small children, elderly persons, sick persons or persons with physical disabilities
- Persons who have delicate skin
- Persons who are exhausted
- Persons who have taken alcohol or drugs which induce sleep (such as sleeping drugs or cold remedies).

To prevent the seat from overheating, do not use the climate control seat if a blanket, cushion, or other insulating object covers the seat. Use also caution not to overuse this feature, which may cool down the occupants excessively.

NOTICE

- *Do not put unevenly weighted objects on the seat . Do not stick sharp objects (such as needles or nails) into the seat.*
- *When cleaning the seats, do not use harsh cleaning substances (such as paint thinner, benzine, alcohol or gasoline). They may damage the climate control seat and seat surface.*
- *Clean the seats using a towel wrung out of water. Entering water in the seats may cause the malfunction of the climate control seats.*
- *To prevent the battery from being discharged, turn the switches off when the engine is not running.*

SWITCHES

Replacing the air filters

The air filters may clog after the long use of the climate control seats which will reduce the air flow. However, you can inspect the filters easily.

When you replace the air filters, be sure to turn off the fans.

Front



► Under the seat

- 1 Remove the air filter locks.
- 2 Remove the air filter.

The front climate control seat filters are located under the driver and front passenger seats.

Replace the air filter when the performance of air flow becomes low by the deterioration of filter.

NOTICE

The air filters should be installed properly in position. The use of front climate control seat with the air filter removed may cause the malfunction of the front climate control seat.

Rear

The rear climate control seat filters are located in the rear side garnishes and under the rear outside passenger seats.

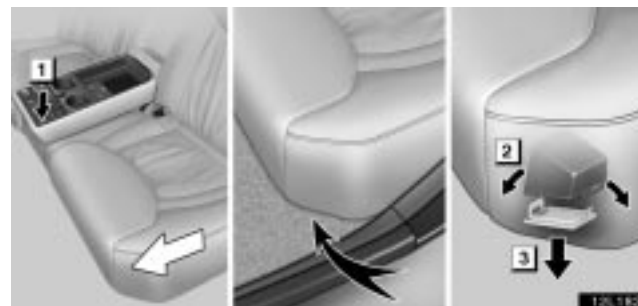

► Under the seat

- 1 Push the rear seat position control button to slide the rear seat to the foremost position.
- 2 Remove the air filter lock under the seat.
- 3 Remove the air filter.

Replace the air filter when the performance of air flow becomes low by the deterioration of filter.

NOTICE

The air filters should be installed properly in position. The use of rear climate control seat with the air filter removed may cause the malfunction of the rear climate control seat.

**► On the side garnish**

The side garnish filters should be replaced at your Lexus dealer. When you replace the filters under the seats, have the side garnish filters replaced as well.

NOTICE

Do not remove the side garnish filters or clean them by washing or air blowing. Doing so may cause the malfunction of the rear climate control seat.

SWITCHES

REFRESHING REAR SEAT SWITCHES

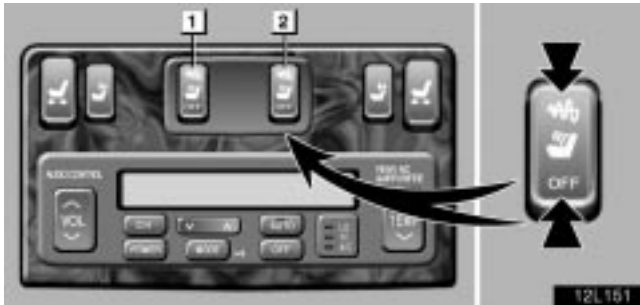

► **1** For left rear seat **2** For right rear seat

The refreshing rear seat is designed to reduce lumbar fatigue by means of a lumbar vibrator.

The ignition switch must be in the "ON" position.

To operate the lumbar vibrator, push the switch on the front side. Keep pushing the switch down to change the vibration speed.

To stop the vibrator, push the switch on the rear side.

CAUTION

- Those who are pregnant, have just given birth, or suffer from heart disease and other ailments requiring rest, should consult a doctor before using the refreshing seat.
- Do not allow children to use the refreshing seat.
- Do not use the refreshing seat immediately after meals or for extended periods.
- If you feel sick while using the refreshing seat, immediately stop using it.

1

SECTION 1 – 3

INSTRUMENTS AND CONTROLS

Gauges, meters and service reminder indicators

Fuel gauge	79
Engine coolant temperature gauge	79
Tachometer	80
Odometer and trip meter	81
Service reminder indicators and warning buzzers	81
Multi-information display	89
Compass	103
Instrument panel light control	107

GAUGES, METERS AND SERVICE REMINDER INDICATORS

FUEL GAUGE



► **Low fuel level warning light**

The gauge indicates the approximate quantity of fuel remaining in the tank when the ignition switch is on.

It is a good idea to keep the tank over 1/4 full.

If the fuel level approaches "E" or the low fuel level warning light comes on, fill the fuel tank as soon as possible.

On inclines or curves, due to the movement of fuel in the tank, the fuel gauge needle may fluctuate or the low fuel level warning light may come on earlier than usual.

If the fuel tank is completely empty, the malfunction indicator lamp comes on. Fill the fuel tank immediately.

The indicator lamp goes off after driving several times. If the indicator lamp does not go off, contact your Lexus dealer as soon as possible.

See the inner back cover for fuel capacity and recommended fuel selection.

ENGINE COOLANT TEMPERATURE GAUGE



► **Normal range**

The gauge indicates the engine coolant temperature when the ignition switch is on. The engine operating temperature will vary with changes in weather and engine load.

If the needle points to the red zone or higher, stop your vehicle and allow the engine to cool.

Your vehicle may overheat during severe operating conditions, such as:

- Driving up a long hill on a hot day.
- Reducing speed or stopping after high speed driving.

GAUGES, METERS AND SERVICE REMINDER INDICATORS

- Idling for a long period with the air conditioning on in stop-and-go traffic.
- Towing a trailer.

NOTICE

- *Do not remove the thermostat in the engine cooling system as this may cause the engine to overheat. The thermostat is designed to control the flow of coolant to keep the temperature of the engine within the specified operating range.*
- *Do not continue driving with an overheated engine. See "If your vehicle overheats" on page 399.*

TACHOMETER



The tachometer indicates engine speed in thousands of rpm (revolutions per minute). Use it while driving to prevent engine over-revving.

Driving with the engine running too fast causes excessive engine wear and poor fuel economy. Remember, in most cases the slower the engine speed, the greater the fuel economy.

NOTICE

Do not let the indicator needle get into the red zone. This may cause severe engine damage.

ODOMETER AND TRIP METER



This meter displays the odometer and two trip meters. To change the mode indication, push the “ODO/TRIP” button briefly. Each time you push the button, the mode changes in order from the odometer to trip meter A to trip meter B, then to the odometer.

The odometer records the total distance the vehicle has been driven. The twin trip meter records two different distances independently.

For example, you can use one meter to calculate the fuel economy and the other to measure the distance on each trip.







To change the trip meter indication from one trip to the other, push the “ODO/TRIP” button. To set the trip meter A to zero, display the meter A reading, then push the “RESET” button. The same applies for the trip B meter.

The data of trip meters will be cancelled if the electrical power source is disconnected.

SERVICE REMINDER INDICATORS AND WARNING BUZZERS

	IF THIS INDICATOR OR BUZZER COMES ON ...	DO THIS.
(a)	BRAKE or	If parking brake is off, stop immediately and contact Lexus dealer.
(b)	 (Indicator and buzzer)	Fasten driver's seat belt.
(c)	 PASSENGER	Fasten front passenger's seat belt.
(d)		Take vehicle to Lexus dealer immediately.
(e)		Stop and check.

GAUGES, METERS AND SERVICE REMINDER INDICATORS

	IF THIS INDICATOR OR BUZZER COMES ON ...	DO THIS.
(f)	 or 	Take vehicle to Lexus dealer.
(g)		See multi-information display.
(h)	 or 	Take vehicle to Lexus dealer. If brake system warning light is also on, stop immediately and contact Lexus dealer
(i)		Close all doors.
(j)	Low fuel level warning light	Fill up tank.

	IF THIS INDICATOR OR BUZZER COMES ON ...	DO THIS.
(k)	Key reminder buzzer	Remove key.

(a) Brake System Warning Light

This light comes on in the following cases when the ignition switch is in the "ON" position.

- **When the parking brake is applied ...**

This light comes on for a few seconds when the ignition switch is turned to the "ON" position even after the parking brake is released.

- **When the brake fluid level is low ...**

 CAUTION
It is dangerous to continue driving normally when the brake fluid level is low.

Have your vehicle checked at your Lexus dealer in the following case:

- The light does not come on even if the parking brake is applied when the ignition switch is in the "ON" position.
- The light does not come on even if the ignition switch is turned on with the parking brake released.

A warning light turning on briefly during operation does not indicate a problem.

 CAUTION
If either of the following conditions occurs, immediately stop your vehicle at a safe place and contact your Lexus dealer.
<ul style="list-style-type: none">• The light does not turn off even after the parking brake is released while the engine is running. <p>In this case, the brakes may not work properly and your stopping distance will become longer. Depress the brake pedal firmly and bring the vehicle to an immediate stop.</p>
<ul style="list-style-type: none">• The brake system warning light remains on together with the "ABS" warning light. <p>In this case, not only the anti-lock brake system will fail but also the vehicle will become extremely unstable during braking.</p>

GAUGES, METERS AND SERVICE REMINDER INDICATORS

(b) Driver's Seat Belt Reminder Light and Buzzer

This light and buzzer remind you to buckle up the driver's seat belt.

Once the ignition switch is turned to "ON" or "START", the reminder light flashes and buzzer sounds if the driver's seat belt is not fastened. Unless the driver fastens the belt, the light stays flashing and the buzzer stops after about 4 to 8 seconds.

(c) Front Passenger's Seat Belt Reminder Light

This light reminds you to buckle up the front passenger's seat belt.

Once the ignition switch is turned to "ON" or "START", the reminder light flashes if a passenger sits in the front passenger seat and does not fasten the seat belt. Unless the front passenger fastens the belt, the light stays flashing. However, if a front passenger uses an additional seat cushion, the indicator light may not flash even when the seat is not buckled up.

If luggage or other load is placed on the front passenger seat, depending on its weight and how it is placed on the seat, the built-in sensor in the seat cushion may detect the pressure, causing the reminder light to flash.

(d) SRS Warning Light

The indicators come on when the ignition switch is turned to the "ON" position. It goes off after about 6 seconds. This means the SRS airbags and seat belt pretensioners are operating properly.

This warning light system monitors the airbag sensor assembly, front airbag sensors, side and curtain shield airbag sensor assemblies, curtain shield airbag sensor assemblies, driver's seat position sensor, driver's seat belt buckle switch, occupant detection sensor, front passenger's seat belt buckle switch, seat belt pretensioner assemblies, inflators, warning light, interconnecting wiring and power sources.

If any of the following conditions occurs, this indicates a malfunction somewhere in the parts monitored by the warning light system. Contact your Lexus dealer as soon as possible to service the vehicle.

- When the ignition switch is turned to the "ON" position, the light does not come on or remains on.
- The light comes on while driving.

If the light stays on, it indicates that the SRS driver and front passenger airbags, SRS side and curtain shield airbags and/or seat belt pretensioners have a problem.

GAUGES, METERS AND SERVICE REMINDER INDICATORS

(e) Discharge Warning Light

This light warns that the battery is being discharged.

If it comes on while you are driving, stop the vehicle, turn off the engine, and check for the cause. Look first at the engine drive belt.

- If it is loose or broken, the generator will not charge the battery properly.
- If the belt is O.K., there is a problem somewhere in the charging system.

The engine ignition will continue to operate, however, until the battery is discharged. Turn off the air conditioning, blower, radio, etc., and drive directly to the nearest Lexus dealer or repair shop.

NOTICE

Do not continue driving if the engine drive belt is broken or loose.

(f) Malfunction Indicator Lamp

This lamp comes on when the ignition switch is turned to the “ON” position and goes off after the engine starts. This means that the warning light system is operating properly.

If the lamp remains on, or the lamp comes on while driving, first check the following:

- Empty fuel tank
If the fuel tank is empty, refuel immediately.
- Loose fuel tank cap
If the fuel tank cap is loose, securely tighten it.

These cases are temporary malfunctions. The malfunction indicator lamp will go off after taking several driving trips.

If the lamp does not go off even after several trips, contact your Lexus dealer as soon as possible.

If the fuel tank is not empty or the fuel tank cap is not loose...

- There is a problem somewhere in the engine, emission control system, electronic throttle control system, automatic transmission electrical system or warning light system itself.

Contact your Lexus dealer as soon as possible to service the vehicle.

If this lamp comes on and the engine speed does not increase with the accelerator pedal depressed, there may be a problem somewhere in your electronic throttle control system.

GAUGES, METERS AND SERVICE REMINDER INDICATORS

At this time, vibration may occur. However, if you depress the accelerator pedal more firmly and slowly, you can drive your vehicle at low speeds. Have your Lexus checked by your Lexus dealer as soon as possible.

Even if the abnormality of the electronic throttle control system is corrected during low speed driving, the system may not be recovered until the engine is stopped and the ignition switch is turned to "ACC" or "LOCK" position.

Emissions inspection and maintenance (I/M) programs

Your vehicle may not pass a state emission inspection if the malfunction indicator lamp remains on. Contact your Lexus dealer to check your vehicle's emission control system and OBD (On- Board Diagnostics) system before taking your vehicle for the inspection.

For details, see "Emissions inspection and maintenance (I/M) programs" on page 440.

(g) Master Warning Light

If any system malfunctions, this warning light comes on or flashes together with a warning tone, and a warning message appears in the multi-information display. When the cause of the problem is eliminated, the warning tone and message on the display will turn off.

(h) "ABS" Warning Light

The light comes on when the ignition switch is turned to the "ON" position. If the anti-lock brake system and the brake assist system work properly, the light turns off after a few seconds. Thereafter, if either of the systems malfunctions, the light comes on again.

When the "ABS" warning light is on (and the brake system warning light is off), the anti-lock brake system, the brake assist system, the traction control system and/or the vehicle stability control system do/does not operate, but the brake system still operates conventionally.

When the "ABS" warning light is on (and the brake system warning light is off), the anti-lock brake system does not operate so that the wheels could lock up during a sudden braking or braking on slippery road surfaces.

GAUGES, METERS AND SERVICE REMINDER INDICATORS

If any of the following conditions occurs, this indicates a malfunction somewhere in the components monitored by the warning light system. Contact your Lexus dealer as soon as possible to service the vehicle.

- The light does not come on when the ignition switch is turned to the "ON" position, or remains on.
- The light comes on while you are driving.

A warning light turning on briefly during operation does not indicate a problem.

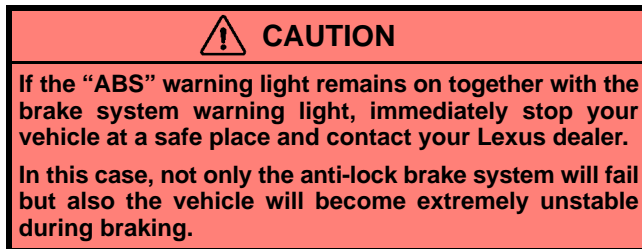

(i) Open Door Warning Light

This light remains on until all the doors are completely closed.

(j) Low Fuel Level Warning Light

This light comes on when the fuel level in the tank becomes very low. Fill the tank as soon as possible.

On inclines or curves, due to the movement of fuel in the tank, the low fuel level warning light may come on earlier than usual.

(k) Key Reminder Buzzer

This buzzer reminds you to remove the key when you open the driver's door with the ignition key in the "ACC" or "LOCK" position.

GAUGES, METERS AND SERVICE REMINDER INDICATORS

How to check all the service reminder indicators

(except the low fuel level warning light):

1. Apply the parking brake.
2. Open the door.

The following service reminder indicator should come on. It goes off when you close the door completely.



3. Turn the ignition switch to "ON".

The following service reminder indicators should come on.



The following service reminder indicator goes off after a few seconds.

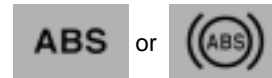

The following service reminder indicator goes off after 6 seconds.



If any service reminder indicator or warning buzzer does not function as described above, have it checked by your Lexus dealer as soon as possible.

MULTI-INFORMATION DISPLAY

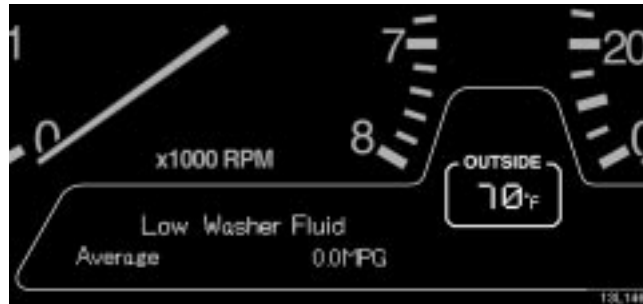

The multi-information display provides various information, including your vehicle's driving condition, outside temperature, and warning messages if your vehicle is in trouble.

During ordinary driving, cruise information and graphic information are displayed. However, if any problem occurs in your vehicle, a warning message appears above the cruise information.

(a) Cruise information



- **1** "DISP1" button **2** "DISP2" button
3 "RESET" button

The following information is shown with the ignition switch turned on. Each time you push the "DISP1" button, the displayed information is changed.

- Available driving distance
- Average fuel consumption
- Current fuel consumption
- Average fuel consumption after being refueled
- Driving distance after being refueled
- Elapsed time
- Average vehicle speed
- Blank

GAUGES, METERS AND SERVICE REMINDER INDICATORS

The displayed cruise information values indicate the general driving condition and may not always reflect precise and actual conditions.

- **Available driving distance**

Range Over 170Mi

▶ *When the fuel gauge is close to "F"*

Range Approx 90.0Mi

▶ *When the fuel gauge is close to middle*

Low Fuel

▶ *When the fuel gauge is close to "E"*

The available driving distance is calculated and displayed depending on the amount of remaining fuel.

- **Average fuel consumption**

Average 18.0MPG

The average fuel consumption is calculated and displayed based on the total driving distance and the total fuel consumption with the engine running.

The value is updated every 10 seconds.

To begin recalculating, push the "RESET" button for about 1 to 2 seconds.

- **Current fuel consumption**

Current 18.0MPG

The current fuel consumption is calculated and displayed based on the driving distance and the fuel consumption per 2 second interval with the engine running.

The value is updated every 2 seconds.

If you are driving at low speeds just before stopping, the accurate figure may not be shown.

- **Average fuel consumption after refueling**

Tank Avg 18.0MPG

The average fuel consumption after refueling is calculated and displayed based on the total driving distance and the total fuel consumption after refueling.

The value is updated every 10 seconds.

When refueling, be sure to stop your vehicle and turn the ignition switch off.

The average fuel consumption could not be calculated in either of the following cases:

- Refueled by opening the fuel filler door using the manual lever in the trunk
- Refueled with a small quantity of gasoline

To begin recalculating, push the "RESET" button for about 1 to 2 seconds.

GAUGES, METERS AND SERVICE REMINDER INDICATORS

The multi-information display shows “Tank Avg -- MPG” for a while after refueling or pushing the “RESET” switch, and then shows the previous average fuel consumption until you start the vehicle.

- **Driving distance after refueling**

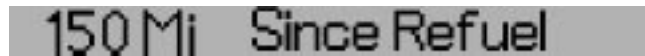
A multi-information display showing the text "150 Mi Since Refuel" in a digital font on a dark background.

The driving distance after refueling is displayed.

When refueling, be sure to stop your vehicle and turn the ignition switch off.

The driving distance after refueling could not be calculated in either of the following cases:

- Refueled by opening the fuel filler door using the manual lever in the trunk
- Refueled with a small quantity of gasoline

To begin recalculating, push the “RESET” button for about 1 to 2 seconds.

- **Elapsed time**

A multi-information display showing the text "Elapsed Time 43:21" in a digital font on a dark background.

The total time that the engine has been running is displayed.

When the engine is started again after the ignition is off, the driving time is added to the previous value. Up to 99 hours 59 minutes can be displayed. When the driving time exceeds 99 hours 59 minutes, the display returns to 0 and recounting starts.

To begin recalculating, push the “RESET” button for about 1 to 2 seconds.

- **Average vehicle speed**

A multi-information display showing the text "Average 30MPG" in a digital font on a dark background.

The average vehicle speed is calculated and displayed based on the total driving distance and the total driving time with the engine running.

The displayed value is updated every 10 seconds.

To begin recalculating, push the “RESET” button for about 1 to 2 seconds.

GAUGES, METERS AND SERVICE REMINDER INDICATORS

(b) Graphic information

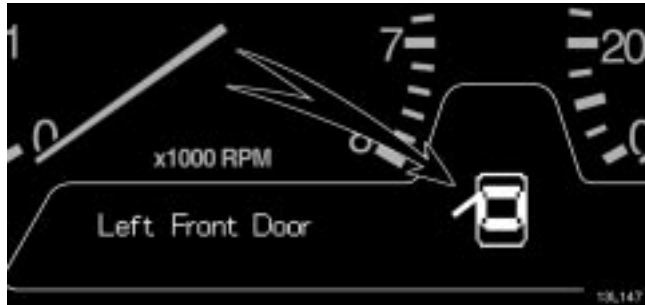

The following graphic information is shown on the display.

- Any door open
- Compass display (if equipped)
- Outside temperature display
- Lexus park assist system display (if equipped)
- Dynamic radar/laser cruise control display (if equipped)
- Blank

If any door is opened, the warning message also reminds you to close the door.

When the ignition is turned on, the previously selected display appears. Each time you push the “DISP2” button for about 1 to 2 seconds, the display changes from compass (if the compass is initially displayed) to outside temperature to blank screen, then back to compass.

For the compass, see “Compass” on page 103. For the outside temperature display, see “Outside temperature display” on page 114.

If you push the main switch of the Lexus park assist system or turn the ignition on with the main switch of the Lexus park assist system on, the Lexus park assist system screen appears for 2 seconds and then the multi-information display returns to the previous screen.

When you push the main switch of the dynamic radar/laser cruise control, the dynamic radar/laser cruise control screen appears. Each time you push the “DISP2” switch for 1 to 2 seconds, the screen changes to compass, outside temperature display, blank screen, and then back to the dynamic radar/laser cruise control screen. When the display shows a screen other than dynamic radar/laser cruise control, the multi-information display returns to the dynamic radar/laser cruise control screen after 6 seconds. For details, see “Dynamic radar/laser cruise control” on page 325.

GAUGES, METERS AND SERVICE REMINDER INDICATORS

(c) Warning messages

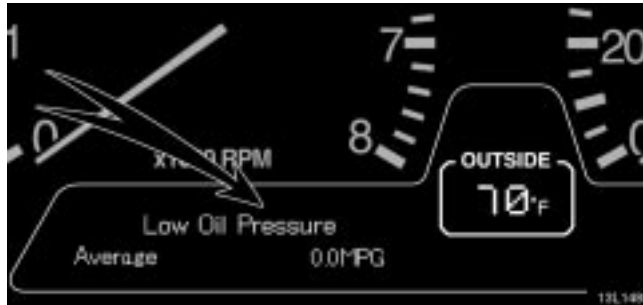

Low Oil Pressure

When the engine oil pressure becomes too low, the master warning light comes on, a warning tone sounds and the above message appears.

If this message appears while you are driving, pull off the road to a safe place and stop the engine immediately. Call a Lexus dealer or qualified repair shop for assistance.

The message may appear when the oil level is extremely low. It is not designed to indicate low oil level, and the oil level must be checked using the oil level dipstick.

NOTICE

Do not drive the vehicle while this warning message is displayed - even for one block. It may ruin the engine.

Brake Wear

When your brake pads have worn down enough to require replacement, the master warning light flashes and a warning tone sounds and the above message appears.

If this message appears while you are driving, have the brake pads checked and replaced by your Lexus dealer as soon as possible.

Low ENG Oil Level

When the engine oil level is too low, the master warning light flashes, a warning tone sounds, and the above message appears.

Add oil as soon as possible. (For instructions, see "Checking the engine oil level" on page 461.)

While driving on steep inclines or rough roads which causes the vehicle to substantially sway or on curves, this message may appear due to the movement of engine oil in the engine.

GAUGES, METERS AND SERVICE REMINDER INDICATORS

In normal conditions, due to engine oil consumption, this message may appear earlier than the specified service interval of the scheduled maintenance. This is because the engine oil is consumed to the low level within the scheduled maintenance interval and does not indicate a problem. (For detailed information, see “Facts about engine oil consumption” on page 459.)

NOTICE

Continued engine operation with low engine oil will damage the engine.

Mileage Reset

This message indicates that the engine oil maintenance data has been reset. After replacing the engine oil, be sure to reset the maintenance data.

To reset the data, perform the following operations:

- 1. Push the “ODO/TRIP” button to change the display to blank.**
- 2. Turn the ignition switch off.**
- 3. Turn the ignition switch to “ON” with the trip meter “RESET” button held down.**
- 4. Keep pushing the “RESET” button for longer than 5 seconds after the ignition is turned on.**

After the above operation, the master warning light comes on, a warning tone sounds and the above message appears to inform you that the engine oil maintenance data has been reset. (U.S.A. only)

GAUGES, METERS AND SERVICE REMINDER INDICATORS

Maint Req'd Soon

If the driving range exceeds 4,500 miles after the engine oil maintenance data is reset, the master warning light comes on, a warning tone sounds and the above message appears for about 15 seconds when you turn the ignition switch to "ON". (U.S.A. only)

This message indicates that the engine oil should be replaced soon. If the message appears, it is recommended to inspect the engine oil with the ignition off. For details about inspection, see "Checking the engine oil level" on page 461.

If the engine oil level is low, engine oil should be replaced. Have it replaced at your Lexus dealer.

After the engine oil replacement, reset the engine oil maintenance data and make sure the "Mileage Reset" appears in the display.

NOTICE

The warning message in the display is based on the driving range after the engine oil maintenance data reset. This is not based on the monitoring of dirty condition of the engine oil.

Maint Req'd

If the driving range exceeds 5,000 miles after the engine oil maintenance data is reset, the master warning light comes on, a warning tone sounds and the above message appears. (U.S.A. only)

This message indicates that the engine oil should be replaced as soon as possible. If the message appears, it is recommended to inspect the engine oil with the ignition off. For details about inspection, see "Checking the engine oil level" on page 461.

If the engine oil level is low, engine oil should be replaced. Have it replaced at your Lexus dealer.

After the engine oil replacement, reset the engine oil maintenance data and make sure the "Mileage Reset" appears in the display.

NOTICE

The warning message in the display is based on the driving range after the engine oil maintenance data reset. This is not based on the monitoring of dirty condition of the engine oil.

GAUGES, METERS AND SERVICE REMINDER INDICATORS

Right Front Door

Left Front Door

Right Rear Door

Left Rear Door

Trunk Open

When any door or trunk is open with the ignition switch turned on, a message appears to let you know which door or trunk is open. If you continue driving in this condition, the master warning light flashes and a warning tone sounds when the vehicle speed exceeds 5 km/h (3 mph).

If any of the above warning messages appears, stop your vehicle and close the door or trunk securely.

Moonroof Open

If the driver's door is opened with the ignition switch turned off and the moon roof opened, the master warning light flashes, a warning tone sounds and the above message appears.

When you leave your vehicle, be sure to close the moon roof.

Park Brake

If you start driving with the parking brake applied, the master warning light flashes, a warning tone sounds and the above message appears when the vehicle speed exceeds 5 km/h (3 mph).

If the above warning message appears, stop your vehicle and release the parking brake.

Check VSC

If the vehicle stability control system or the traction control system malfunctions, the master warning light and "TRAC OFF" indicator light come on. At this time a warning tone sounds and the above message appears.

If the message appears, the vehicle stability control system and traction control system do not work. Although it is no problem to continue driving, have your vehicle checked by Lexus dealer as soon as possible.

GAUGES, METERS AND SERVICE REMINDER INDICATORS

Low Tire

When the low tire inflation pressure is detected while driving, the master warning light comes on, the above message appears and a warning tone sounds.

If the above message appears, stop your vehicle at a safe place and adjust the tire inflation pressure to the specified level. The warning message will go out after driving over about 30 km/h (19 mph) for a while. If the message still remains on, have your vehicle checked by your Lexus dealer as soon as possible.

Check System

If there is a problem electrically in the tire pressure warning system, the master warning light comes on, the above message appears and a warning tone sounds. At this time the multi-information display indicates which part causes an error.

Although it is no problem to continue driving with the above message on the display, have your vehicle checked by your Lexus dealer as soon as possible.

Pressure Initial

This message indicates the tire pressure warning system is initialized. After replacing the tires or wheels, adjust all 4 tires to specified tire inflation pressure and initialize the tire pressure warning system. To initialize the system, turn the ignition switch to “ON” and push the tire pressure warning system reset switch for longer than 3 seconds with the vehicle stopped. The above message appears.

Low Washer Fluid

When the fluid level in the tank becomes very low, the master warning light comes on, a warning tone sounds and the above message appears.

Fill the tank as soon as possible.

GAUGES, METERS AND SERVICE REMINDER INDICATORS

Change A/C Filter

When the air conditioning filter should be replaced, the master warning light comes on, a warning tone sounds and the above message appears.

If the "Change A/C Filter" appears on the multi-information display, change the air conditioning filter as soon as possible because the air filter might have clogged. See "Replacing the air conditioning filter" on page 246 for details.

A/C Filter Reset

If you push the "OFF" button for the front air conditioning for about more than 4 seconds after the replacement of the air conditioning filters, the above message appears and the attention tone sounds to inform you that the data has been reset.

When you push the "OFF" button for the front air conditioning for more than 4 seconds before "Change A/C Filter" appears, the data will be cleared. Do not reset the data before this message appears.

S/T Lock CBL Failure

If the interlock cable for steering lock is faulty, the master warning light flashes, a warning tone sounds and the above message appears.

If the above message appears, contact your Lexus dealer as soon as possible.

Key is not Detected

In the following cases, the master warning light flashes, a warning tone sounds and the above message appears.

- A smart key is not detected in the vehicle when you push the ignition switch. In this case, the above message appears for 5 seconds.
- A smart key is not detected in the vehicle because someone has taken a smart key outside of the vehicle without turning off the ignition. At this time, the smart key sounds an alarm. The above message turns off if you turn the ignition off or the smart key system detects a smart key in the vehicle.

In addition to either of the above conditions, if you get out from the vehicle, having a smart key when the ignition switch is in the "ACC" or "ON" position and the selector lever is in a position other than "P," "Shift to P Range" and "Key is not Detected" appear alternately.

GAUGES, METERS AND SERVICE REMINDER INDICATORS

Shift to P Range

If you get out from the vehicle, having a smart key when the ignition switch is in the “ACC” or “ON” position and the selector lever is in a position other than “P”, the master warning light flashes, a beep sounds inside the vehicle and the above message appears. When you shift the selector lever to the “P” position or start driving, the beeping stops sounding, the above message turns off.

In addition to the above condition, if the smart key system does not detect a smart key in the vehicle, “Shift to P Range” and “Key is not Detected” appear alternately.

Key is Different

If the smart key system determines that the electronic code of the detected key does not correspond to the registered ID when you push the ignition switch or lock button on the outside door handle, the master warning light flashes, a warning tone sounds and the above message appears for 5 seconds.

Low Key Battery

If the smart key system determines that the battery voltage is low (2V to 3V) when the ignition is turned off more than 20 minutes after turned on, the master warning light flashes, a warning tone sounds and the above message appears for 5 seconds.

If the above message appears, the battery needs to be replaced. Although you can replace the battery referring to “Replacing the battery (Type A)” on page 42, we recommend you have it replaced by your Lexus dealer as it is easy to be scratched.

Height Hi

The above message appears when the high mode in the electronically modulated air suspension is selected. However, if the system fails, the master warning light comes on, a warning tone also sounds and the above message appears.

Although it is no problem to continue driving, have your vehicle checked by your Lexus dealer as soon as possible.

GAUGES, METERS AND SERVICE REMINDER INDICATORS

Check Park Sonar

If the sensor of the Lexus park assist system is malfunctioning or a cable is broken when the Lexus park assist system is on, the master warning light comes on, a warning tone sounds, the malfunctioning sensor flashes and the above message appears.

The flashing sensor does not operate properly. Although it is no problem to continue driving, have your vehicle checked by your Lexus dealer as soon as possible.

Clean Park Sonar

If icicles, snowflakes or mud gets on the sensor of the Lexus park assist system or it is frozen when the Lexus park assist system is on, the sensor not be able to detect an obstacle flashes and the above message appears.

Remove the foreign matter or deice the sensor. If the message does not appear after cleaning, the system is operating properly.

Clean Radar Sensor

Dynamic radar cruise control—

If the system cannot easily measure the vehicle-to-vehicle distance because of a dirty millimeter wave radar sensor or grille cover while the dynamic radar cruise control is on, the master warning light comes on and the “CRUISE” indicator light flashes. At this time a warning tone sounds and the above message appears.

If this message appears, clean the sensor and grille cover with a soft cloth and try setting the preset speed again. If the dirt is removed without cleaning, the system will automatically enter the “RADAR READY” mode. If the system does not enter the “RADAR READY” mode even after cleaning or the message remains on the display, the system might be malfunctioning. Although it is no problem to continue driving, contact your Lexus dealer.

GAUGES, METERS AND SERVICE REMINDER INDICATORS

Dynamic laser cruise control—

If the system cannot easily measure the vehicle-to-vehicle distance because of a dirty laser radar sensor glass while the dynamic laser cruise control is on, the master warning light comes on and the “CRUISE” indicator light flashes. At this time a warning tone sounds and the above message appears.

If this message appears, clean the sensor glass with a soft cloth and try setting the preset speed again. If the dirt is removed without cleaning, the system will automatically enter the “RADAR READY” mode. If the system does not enter the “RADAR READY” mode even after cleaning or the message remains on the display, the system might be malfunctioning. Although it is no problem to continue driving, contact your Lexus dealer.

A rectangular box with a grey background and the text "Cruise not Available" in a white, sans-serif font.

If the system cannot easily measure the vehicle-to-vehicle distance because of the following conditions while the dynamic radar/laser cruise control is on, the master warning light comes on, the “CRUISE” indicator light flashes, and a warning tone sounds. At this time the above message appears.

Dynamic radar cruise control—

- The driving pattern selector switch is set to the “SNOW” mode.
- It is determined that it is difficult to make a measurement because of bad weather (such as extremely hot weather)
- The wipers are operated at high speed with the wiper lever in the “AUTO” position

Dynamic laser cruise control—

- The driving pattern selector switch is set to the “SNOW” mode.
- It is determined that it is difficult to make a measurement because of bad weather (such as rainy, foggy, or snowy weather)
- The wipers are operated at high or low speeds with the wiper lever in the “AUTO” position.
- Direct sunlight from the front

GAUGES, METERS AND SERVICE REMINDER INDICATORS

In the following cases, the dynamic radar/laser cruise control switches to the “RADAR READY” mode:

Dynamic radar cruise control—

- The driving pattern selector switch is changed to the “normal” or “power” position.
- The wipers are stopped or are switched to low speed or intermittent operation. (Including intermittent and stopped wipers in the “AUTO” position)

In the above conditions, press the control lever upward in the “RES/ACC” direction and release it. The dynamic radar cruise control will be restored, however, even after the weather clears, if the setting operation cannot be performed or if the warning message still appears, the system might have malfunctioned. Although it is no problem to continue driving, contact your Lexus dealer.

Dynamic laser cruise control—

- The driving pattern selector switch is changed to the “normal” or “power” position.
- The wipers are stopped or are switched to intermittent operation. (Including intermittent and stopped wipers in the “AUTO” position)
- No direct sunlight from the front

In the above conditions, press the control lever upward in the “RES/ACC” direction and release it. The dynamic laser cruise control will be restored, however, even after the weather clears, if the setting operation cannot be performed or if the warning message still appears, the system might have malfunctioned. Although it is no problem to continue driving, contact your Lexus dealer.

Check Cruise System

If a system malfunction is detected when dynamic radar/laser cruise control is in the “RADAR READY” mode or operating, the master warning light comes on, the “CRUISE” indicator light flashes and a warning tone sounds. At this time the above message appears.

If this message appears, stop your vehicle in a safe place, turn the ignition off, and then restart it to reset the system. If the setting still cannot be made or the same message appears again, the system might have malfunctioned. Although it is no problem to continue driving, contact your Lexus dealer.

NOTICE

While you are cruising with the dynamic radar/laser cruise control on, if the master warning light comes on, the cruise indicator light flashes, “Check Cruise System” appears on the multi-information display and the warning tone sounds, turn the ignition switch off and then on again. If the function is cancelled again after setting or if settings cannot be made, the dynamic radar/laser cruise control system may be malfunctioning. Although it is no problem to continue driving, have your vehicle checked by your Lexus dealer.

COMPASS

(Vehicles without Navigation System)



When the ignition is turned on, the previously selected display appears. If the compass is not displayed, push the “DISP2” button several times for 1 to 2 seconds to display the compass. However if you push the main switch of dynamic radar/laser cruise control to use dynamic radar/laser cruise control, the dynamic radar/laser cruise control display appears. To change to the compass display, push the “DISP2” button for longer than about 1 second.

The compass indicates the direction in which the vehicle is heading. The illustration shown above indicates that the vehicle is heading north.

GAUGES, METERS AND SERVICE REMINDER INDICATORS

Displays	Directions
N	North
NE	Northeast
E	East
SE	Southeast
S	South
SW	Southwest
W	West
NW	Northwest

The compass may not show the correct direction in the following conditions:

- The vehicle is stopped immediately after turning.
The compass does not adjust while the vehicle is stopped.
- The ignition switch is turned off immediately after turning.
- The vehicle is on an inclined surface.
- The vehicle is in a place where the earth's magnetic field is subject to interference by artificial magnetic fields (underground parking, under a steel tower, between buildings, roof parking, near a crossing, near a large vehicle, etc.).

- The vehicle is magnetized. (There is a magnet or a metal object near the audio system.)
- The battery has been disconnected.

If the deviation is small, the compass works to calibrate the direction automatically while the vehicle is in motion.

For obtaining additional precision or for complete calibrating, see "CALIBRATING THE COMPASS" on page 105.

COMPASS SENSOR



► *Compass sensor*

The compass sensor is located behind the audio system.

NOTICE

Do not put magnets or a metal object near the audio system. Doing this may cause malfunction of the compass sensor.

CALIBRATING THE COMPASS

The direction display on the compass deviates from the true direction determined by the earth's magnetic field. The amount of deviation varies according to the geographic position of the vehicle.

If you cross over the area divided as shown in the illustration, the compass will deviate. If it is necessary to calibrate the compass (deviation calibration), take your vehicle to your Lexus dealer. Even if you do not cross over, the compass may sometimes deviate. If this happens, perform "DRIVE IN CIRCLES" calibration as shown on the next page.

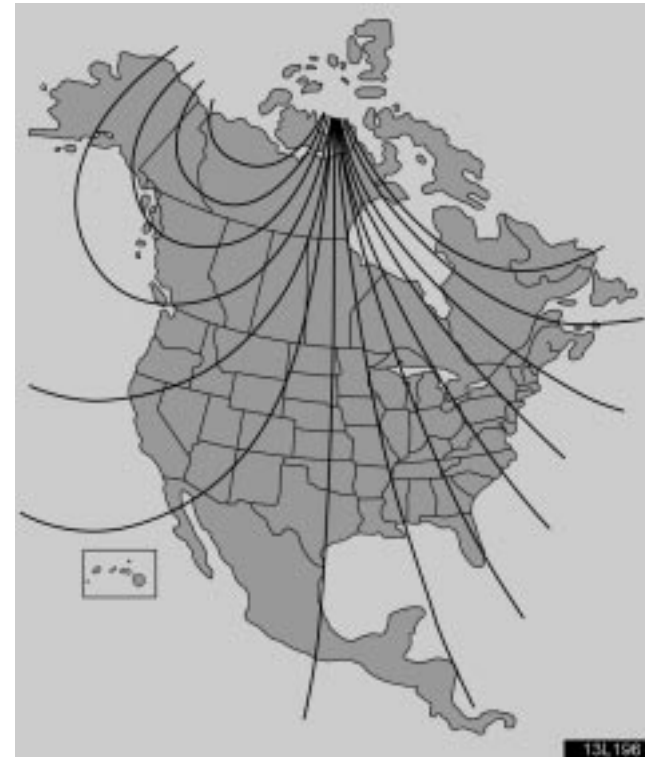

GAUGES, METERS AND SERVICE REMINDER INDICATORS



To rectify the deviation, stop the vehicle, and push and hold the "RESET" button on the steering pad for more than 6 seconds. "DRIVE IN CIRCLES" appears on the display. Perform the following calibration.



CAUTION

Do not adjust the display while the vehicle is moving. Be sure to adjust the display only when the vehicle is stopped.

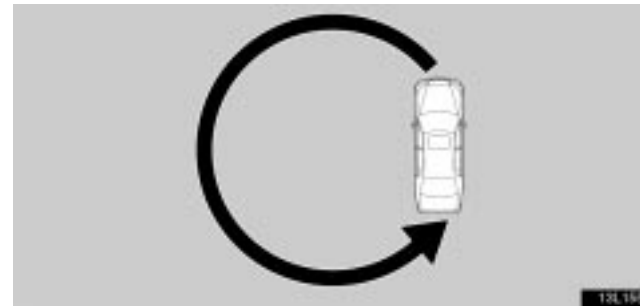

Drive the vehicle slowly (at 8 km/h (5 mph) or lower) in a circle until the direction is displayed. If there is not enough space to drive in a circle, drive around the block until the direction is displayed.

After driving in 1 to 3 circles in the above method, calibration is complete with the direction shown on the display.

If calibration cannot be performed because the vehicle is magnetized, take your vehicle to a Lexus dealer.

If you want to cancel the calibration before it is complete, push and hold the "RESET" button on the steering pad more than 6 seconds. To calibrate the compass again, push and hold the same button more than 6 seconds. After "DRIVE IN CIRCLES" appears on the display, follow the calibration procedure above.

Perform circling calibration just after you have purchased your Lexus. And then always perform circling calibration after the battery has been removed, replaced or disconnected.

GAUGES, METERS AND SERVICE REMINDER INDICATORS

- Do not perform circling calibration of the compass in a place where the earth's magnetic field is subject to interference by artificial magnetic fields (underground parking, under a steel tower, between buildings, roof parking, near a crossing, near a large vehicle, etc.).
- During calibration, do not operate electric systems (moon roof, power windows, etc.) as they may interfere with the calibration.

CAUTION

- When doing the circling calibration, be sure to secure a wide space, and watch out for people and vehicles in the neighborhood. Do not violate any local traffic rules while performing circling calibration.
- Do not adjust the display while the vehicle is moving. Be sure to adjust the display only when the vehicle is stopped.

INSTRUMENT PANEL LIGHT CONTROL



To adjust the brightness of the instrument panel lights, turn the knob.

With the knob turned fully right, the intensity of the instrument panel lights will not be reduced when the headlight switch is on.

SECTION 1 - 4

INSTRUMENTS AND CONTROLS

Interior equipment

Sun visors	109
Interior lights	109
Personal lights	111
Ignition switch light	112
Foot lights	113
Clock	113
Outside temperature display	114
Cigarette lighter and ashtray	116
Power outlets	117
Rear console box	118
Glove box	119
Garage door opener	119
Cup holders	123
Coin box	124
Overhead console box	125
Auxiliary boxes	126
Trunk storage extension	128
Card holder	130
Penlight	130
Cool box	131
Floor mat	132
Coat hooks	133
Sunshades	134
Luggage net	136
First-aid kit net	137

SUN VISORS

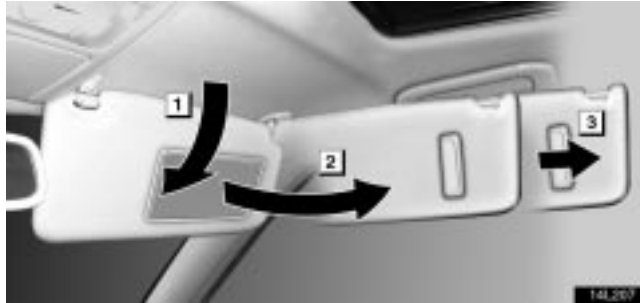

To block out glare, move the sun visor as shown.

- 1 To block out glare from the front , swing the sun visor down.
- 2 To block out glare from the side, remove the sun visor from the hook and swing it to the side.
- 3 To block out glare coming obliquely from behind you, slide the visor backwards.

At this position, the vanity light may not come on.

At this position, the vanity light does not come on.

INTERIOR LIGHTS

Front

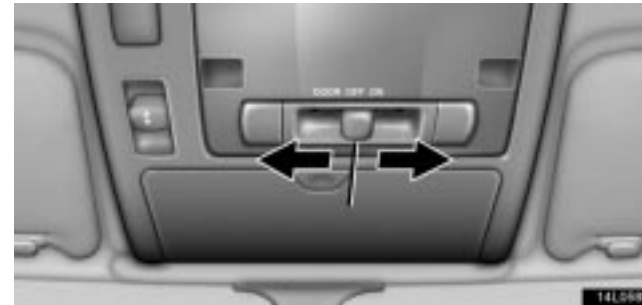

► Vehicles with moon roof



► Vehicles without moon roof

INTERIOR EQUIPMENT

To turn on the interior light, slide the switch.

With the switch in the "DOOR" position, the light comes on when any doors are opened or when the ignition switch is turned to "LOCK". After all the doors are closed, the light remains on for about 15 seconds and then goes out.*

However, in the following cases, the light goes out immediately:

1. All the doors are closed when the ignition switch is in "ACC" or "ON" position.
2. The ignition switch is turned to "ACC" or "ON" when the light is still on.
3. All the doors are locked when the light is still on.
4. One door is closed with the lock button pushed in while the other doors are locked.

NOTE:

* The interior lights can be set not to come on or the duration of lighting can be changed.

Ask your Lexus dealer for details.

Rear



► Vehicles with rear air conditioning controls



► Vehicles without rear air conditioning controls

When you open the rear door, the light turns on. Closing it turns off the light.

PERSONAL LIGHTS

Front

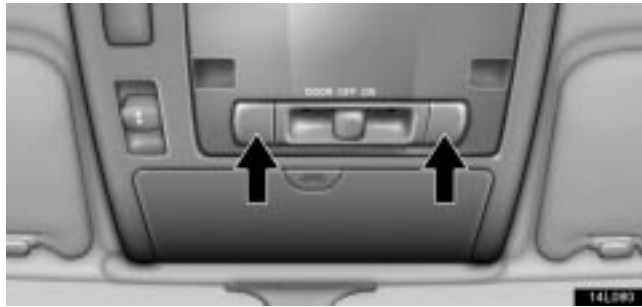

► *Vehicles with moon roof*

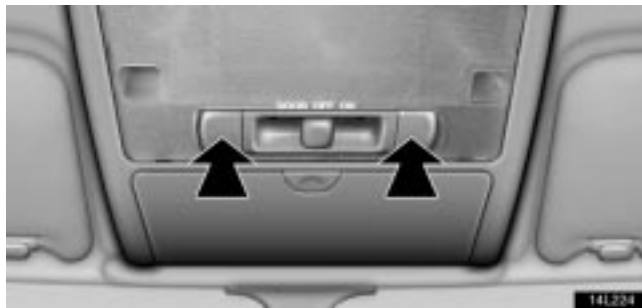

► *Vehicles without moon roof*

Rear



► *Vehicles with rear air conditioning controls*

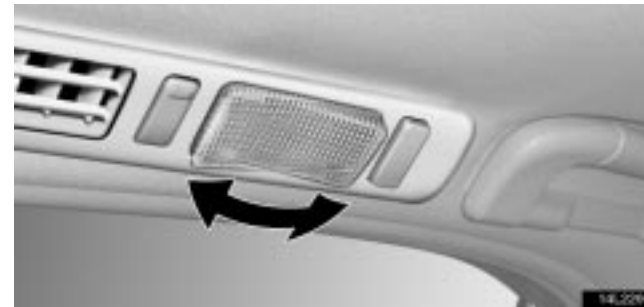

You can change the personal light angle manually as you like.

INTERIOR EQUIPMENT



► **Vehicles without rear air conditioning controls**

To turn on the personal light, push the switch. To turn it off, push the switch again.

IGNITION SWITCH LIGHT



► **1 Type A 2 Type B**

For easy access to the ignition switch, the ignition switch light comes on when any of the doors are opened.

The light remains on for about 15 seconds and goes out after all the doors are closed. However, the light goes out immediately when all the doors are locked or the ignition switch is in the "ACC" or "ON" position.

FOOT LIGHTS

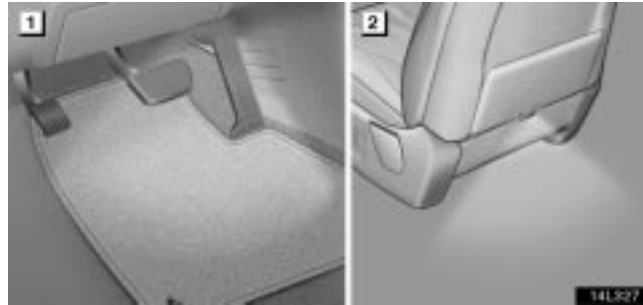

► **1** *Front foot light* **2** *Rear foot light*

The foot lights come on and go out in the following conditions.*

- The lights come on for about 15 seconds when any of the doors are opened. However, when all the doors are closed and locked, the lights go out immediately.
- The lights come on when the ignition switch is turned to “ON” from “ACC” with the selector lever in the “P” position. When you move the lever out of “P” position, the intensity of the lights are reduced.

When the instrument panel light control knob is turned fully counterclockwise, the foot lights will turn off.

CLOCK



► *Vehicles with navigation system*

For clock setting, see the separate “Navigation System Owner’s Manual”.

INTERIOR EQUIPMENT

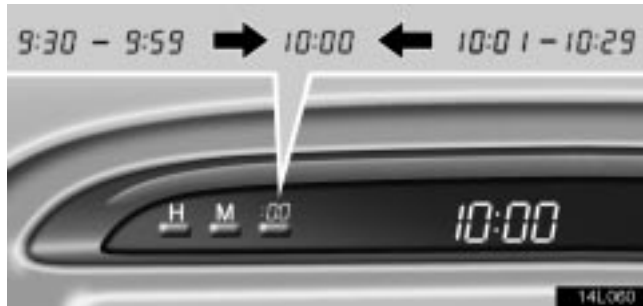

► Vehicles without navigation system

The digital clock indicates the time with the ignition switch at the “ACC” or “ON” position. To reset the hour, press the “H” button. To reset the minutes, press the “M” button. To adjust the time to the nearest hour, press the “:00” button.

For example, if the “:00” button is pressed when the time is between 9:30 - 9:59 or between 10:01 - 10:29, the time will change to 10:00.

If the electrical power source has been disconnected from the clock, the time display will automatically be set to 1:00 (one o'clock).

OUTSIDE TEMPERATURE DISPLAY



► On the instrument panel (Vehicles with navigation system)



► **On the instrument panel (Vehicles without navigation system)**

This display shows the outside temperature when the ignition switch is on.

The displayed temperature ranges from -30°C (-22°F) up to 50°C (122°F). If the temperature does not appear on the display or it shows “- -”, take your vehicle to your Lexus dealer.



► **Multi-information display**

When you push the “DISP2” switch with the ignition switch on, another outside temperature display appears on the multi-information display. (For details, see “Multi-information display” on page 89.)

The displayed temperature ranges from -30°C (-22°F) up to 50°C (122°F). If the temperature does not appear on the display or it shows “- -”, take your vehicle to your Lexus dealer.

INTERIOR EQUIPMENT

CIGARETTE LIGHTER AND ASHTRAY



► *Front cigarette lighter and ashtray (for some models)*



► *Rear cigarette lighter and ashtray*

Open the ashtray cover. To use the cigarette lighter, press in the cigarette lighter. After it finishes heating up, it automatically pops out ready for use.

Do not hold the cigarette lighter pressed in.

If the engine is not running, the ignition switch must be in the "ACC" position to use the lighter.

When finished with your cigarette, thoroughly extinguish it in the ashtray to prevent other cigarette butts from catching fire. After using the ashtray, push it back in or close the lid completely.

To remove the ashtray, raise the lid and pull it out.

Use a Lexus genuine cigarette lighter or equivalent for replacement.

CAUTION

To reduce the chance of injury in case of an accident or sudden stop while driving, always close the ashtray completely after use.

POWER OUTLETS

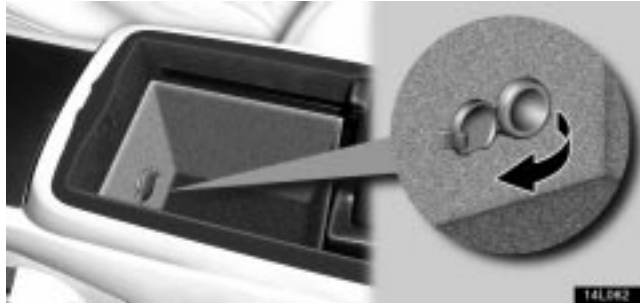

► In the rear console box



► On the right side of the selector lever (for some models)

The power outlets are designed for power supply for car accessories.

The ignition switch must be in the “ACC” or “ON” position for the power outlets to be used.

NOTICE

- *To prevent the fuse from being blown, do not use the electricity over the total vehicle capacity of 10A/12V.*
- *To prevent the battery from being discharged, do not use the power outlets longer than necessary when the engine is not running.*
- *Close the power outlet lids when the power outlets are not in use. Inserting anything other than an appropriate plug that fits the outlet, or allowing any liquid to get into the outlet may cause electrical failure or short circuits.*

INTERIOR EQUIPMENT

REAR CONSOLE BOX

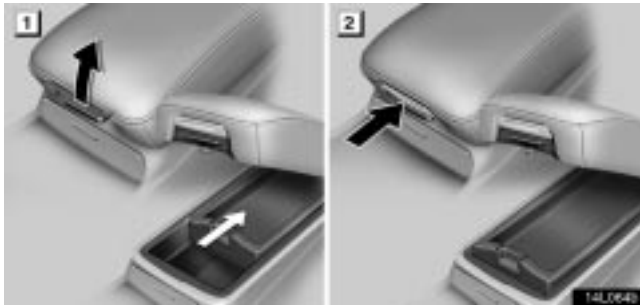

► **1** For the lower box **2** For the upper tray

To use the rear console box, open as shown in the illustration.



Sliding a tray will make an accommodating space larger.

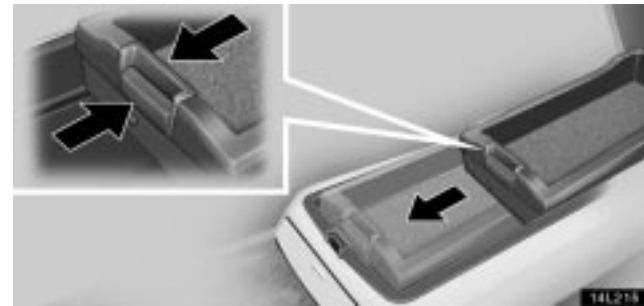

To return the tray to its original position, slide it while pushing either lever as shown.

The rear console box light for the lower box will come on with the headlights on.

CAUTION

To reduce the chance of injury in case of an accident or a sudden stop, always keep the console box lid closed while driving.

GLOVE BOX

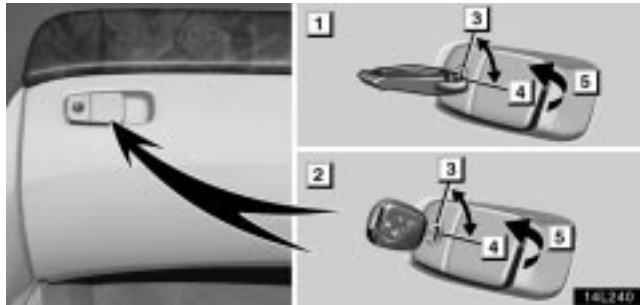

► **1** Type A **2** Type B **3** Unlock **4** Lock **5** Open

To open the glove box door, pull the lever. To lock the glove box door, insert the master key and turn it clockwise.

With the tail lights on, the glove box light will come on when the glove box door is open.

CAUTION

To reduce the chance of injury in case of an accident or a sudden stop, always keep the glove box door closed while driving.

GARAGE DOOR OPENER

The garage door opener (**HomeLink®** Universal Transceiver) is manufactured under license from HomeLink® and can be programmed to operate garage doors, gates, entry doors, door locks, home lighting systems, and security systems, etc.

(a) Programming the HomeLink®



► **1** Buttons **2** Indicator light

The HomeLink® in your vehicle has 3 buttons and you can store one program for each button.

To ensure correct programming into the HomeLink®, install a new battery in the hand-held transmitter prior to programming.

INTERIOR EQUIPMENT

The battery side of the hand-held transmitter must be pointed away from the HomeLink[®] during the programming process.

For Canadian users, follow the procedure in “Programming an entrance gate/Programming all devices in the Canadian market”.

1. Decide which of 3 HomeLink[®] buttons you want to program.
2. Place your hand-held garage transmitter 25 to 75 mm (1 to 3 in.) away from the surface of the HomeLink[®].

Keep the indicator light on the HomeLink[®] in view while programming.

3. Simultaneously press and hold the hand-held garage transmitter button along with the selected HomeLink[®] button.
4. When the indicator light on the HomeLink[®] changes from a slow to a rapid flash after 20 seconds, you can release both buttons.
5. Test the operation of the HomeLink[®] by pressing the newly programmed button. If programming a garage door opener, check to see if the garage door opens and closes.

If the garage door does not operate, identify if your garage transmitter is of the “Rolling Code” type. Press and hold the programmed HomeLink[®] button. The garage door has the rolling code feature if the indicator light (on the HomeLink[®]) flashes rapidly and then remains lit after 2 seconds. If your garage transmitter is the “Rolling Code” type, proceed to the heading “Programming a rolling code system”.

6. Repeat steps 2 through 5 for each remaining HomeLink[®] button to program another device.

Programming a rolling code system

If your device is “Rolling Code” equipped, it is necessary to follow steps 1 through 4 under the heading “Programming the HomeLink[®]” before proceeding with the steps listed below.

1. Locate the “training” button on the ceiling mounted garage door opener motor. The exact location and color of the button may vary by brand of garage door opener. Refer to the owner’s guide supplied by the garage door opener manufacturer for the location of this “training” button.

2. Press the “training” button on the ceiling mounted garage door opener motor.

Following this step, you have 30 seconds in which to initiate step 3 below.

3. Press and release the vehicle’s programmed HomeLink[®] button twice. The garage door may open. If the door does not open, the programming process is complete. If the door does not open, press and release the button a third time. This third press and release will complete the programming process by opening the garage door.

The ceiling mounted garage door opener motor should now recognize the HomeLink[®] unit and be able to activate the garage door up/down.

4. Repeat steps 1 through 3 for each remaining HomeLink[®] button to program another rolling code system.

**Programming an entrance gate /
Programming all devices in the Canadian
market**

1. Decide which of the 3 HomeLink[®] buttons you want to program.
2. Place your hand-held gate/device transmitter 25 to 75 mm (1 to 3 in.) away from the surface of the HomeLink[®].

Keep the indicator light on the HomeLink[®] in view while programming.

3. Press and hold the selected HomeLink[®] button.
4. Continuously press and release (cycle) the hand-held gate/device transmitter button every two seconds until step 5 is complete.
5. When the indicator light on the HomeLink[®] changes from a slow to a rapid flash after 20 seconds, you can release both buttons.
6. Test the operation of the HomeLink[®] by pressing the newly programmed button. Check to see if the gate/device operates correctly.
7. Repeat steps 1 through 6 for each remaining HomeLink[®] button to program another device.

Programming other devices

To program other devices such as home security systems, home door locks or lighting, contact your authorized Lexus dealer for assistance.

Reprogramming a button

Individual HomeLink[®] buttons cannot be erased, however, to reprogram a single button, follow the procedure “Programming the HomeLink[®]”.

(b) Operating the HomeLink[®]

To operate the HomeLink[®], press the appropriate HomeLink[®] button to activate the programmed device. The HomeLink[®] indicator light should come on. The HomeLink[®] continues to send the signal for up to 20 seconds as long as the button is pressed.

INTERIOR EQUIPMENT

(c) Erasing the entire HomeLink® memory (all three programs)

To erase all previously programmed codes at one time, press and hold down the 2 outside buttons for 20 seconds until the indicator light flashes.

If you sell your vehicle, be sure to erase the programs stored in the HomeLink® memory.



CAUTION

- When programming the HomeLink® Universal Transceiver, you may be operating a garage door or other device. Make sure people and objects are out of the way of the garage door or other device to prevent potential harm or damage.
- Do not use this HomeLink® Universal Transceiver with any garage door opener that lacks the safety stop and reverse feature as required by federal safety standards. (This includes any garage door opener model manufactured before April 1, 1982.) A garage door opener which cannot detect an object (signaling the door to stop and reverse), does not meet current federal safety standards. Using a garage door opener without these features increases risk of serious injury or death.

This device complies with Part 15 of the FCC Rules and with RSS-210 of the Industry Canada. Operation is subject to the following two conditions: (1) This device may not cause harmful interference, and (2) this device must accept any interference received, including interference that may cause undesired operation.

WARNING: This transmitter has been tested and complies with FCC and Industry Canada DOC/MPAC rules. Changes or modifications not expressly approved by the party responsible for compliance could void the user's authority to operate the device.

CUP HOLDERS

Front



To use the cup holder, push the top of the cup holder portion of the rear console box.

The cup holder is designed for holding cups or drink-cans securely. When the cup holder is in use, keep the rear console box closed.

CAUTION

- Do not place anything else other than cups or drink-cans in the cup holder, as such items may be thrown about in the compartment and possibly injure people in the vehicle during sudden braking or in an accident.
- To reduce the chance of injury in case of an accident or sudden stop while driving, keep the cup holder closed when not in use.

Rear



► *Vehicles with rear power seats*

INTERIOR EQUIPMENT



► Vehicles without rear power seats

To use the cup holder, open the cup holder portion of the center armrest in the rear seat.

The cup holder is designed for holding cups or drink-cans securely.

CAUTION

- Do not place anything else other than cups or drink-cans in the cup holder, as such items may be thrown about in the compartment and possibly injure people in the vehicle during sudden braking or in an accident.
- To reduce the chance of injury in case of an accident or sudden stop while driving, keep the cup holder closed when not in use.

COIN BOX



To use the coin box, push the coin box button.

CAUTION

Keep the coin box closed when not in use.

OVERHEAD CONSOLE BOX



To use the overhead console box, push the button.

CAUTION

- To reduce the chance of injury in case of an accident or a sudden stop, always keep the overhead console box closed while driving.
- Do not place any object heavier than 100 g (0.22 lb.) in it. Heavier objects may cause the box to open and the contents to fly out resulting in injuries.

NOTICE

During hot weather, the interior of the vehicle becomes very hot. Do not leave anything flammable or deformable such as a lighter, glasses, etc. inside.

INTERIOR EQUIPMENT

AUXILIARY BOXES

Your vehicle has several types of auxiliary box. To use them, open as shown in the following illustrations.

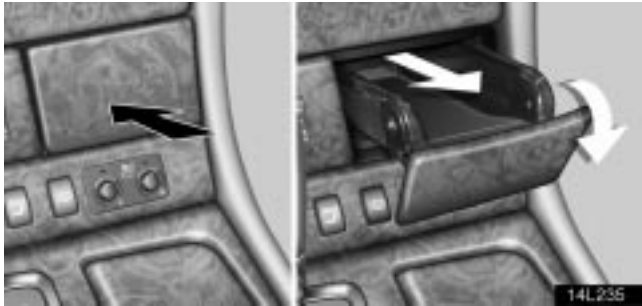

► *On the instrument panel*



CAUTION

As this box is designed for holding eyeglasses or cellular phones, do not place any objects heavier than 300 g (0.44 lb.) in it.

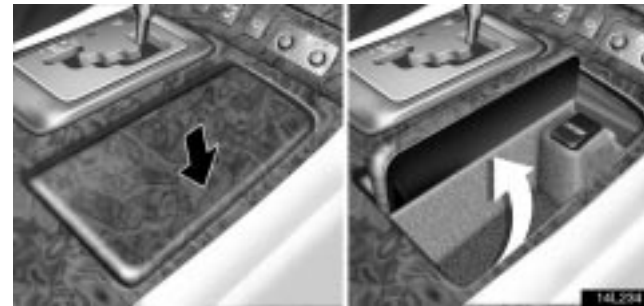

► *On the right side of the selector lever (for some models)*

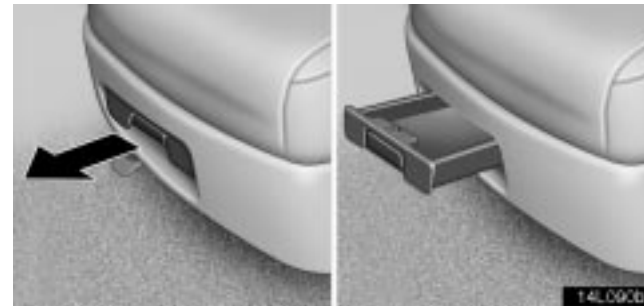

► *Under the driver's seat*

INTERIOR EQUIPMENT



► *Under the front passenger's seat*

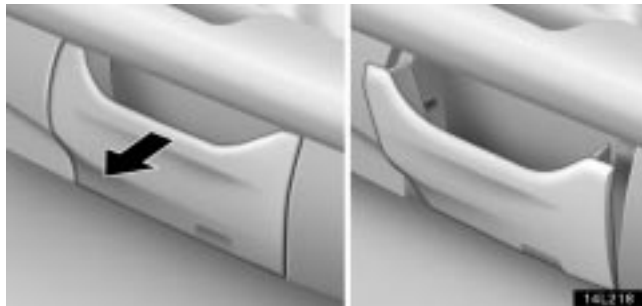

► *On the inner side of the front doors*



► *Rear seat armrest
(Vehicles with rear power seats)*



► *Rear seat armrest
(Vehicles without rear power seats)*

INTERIOR EQUIPMENT

CAUTION

To reduce the chance of injury in case of an accident or a sudden stop, always keep the auxiliary boxes closed while driving.

TRUNK STORAGE EXTENSION

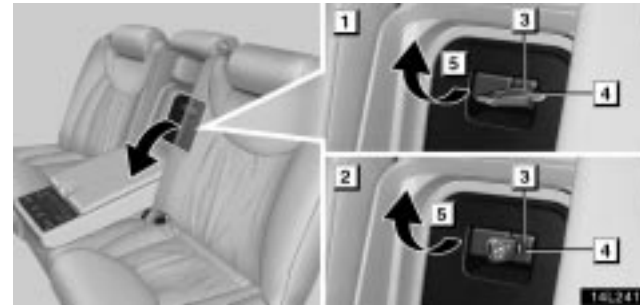

- **1** Type A **2** Type B
3 Unlock **4** Lock **5** Open

Pull down the center armrest in the rear seat. Pull the lever and open the door.

Be sure to use “LEXUS Genuine Sports Gear, Bag” or carry long objects (ski boards, poles, etc.) properly.

For installation and handling of the “LEXUS Genuine Sports Gear”, follow the instructions provided with goods.

You can use a container as an accessory box. To lock the box, insert the master key and turn it clockwise.

⚠ CAUTION

To reduce the chance of injury in case of an accident or a sudden stop, always keep the container closed while driving.

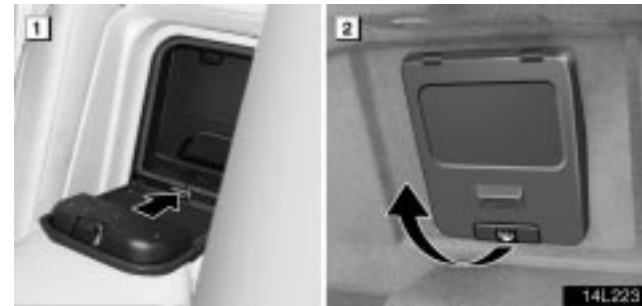

- ▶ **1** *From passenger compartment side*
- 2** *From trunk side*

To extend a storage space, push the button on the door to unlock and then push the door from the passenger side or pull it from the trunk side.

See “Cargo and luggage” on page 389 for precautions to observe in loading luggage.

⚠ CAUTION

Be sure to close the door when the trunk storage extension is not in use. Luggage or cargo in the trunk may be thrown into the passenger compartment in a sudden stop or crash resulting in injury.

INTERIOR EQUIPMENT

CARD HOLDER

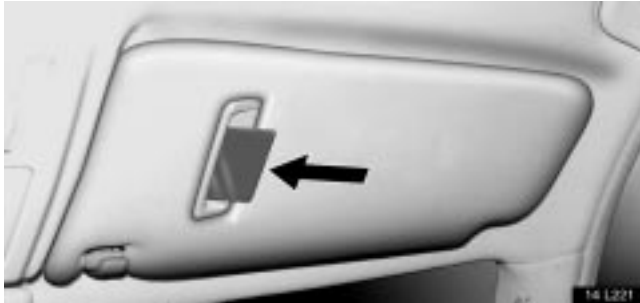

You can store a card in the slot as shown in the illustration.

PENLIGHT

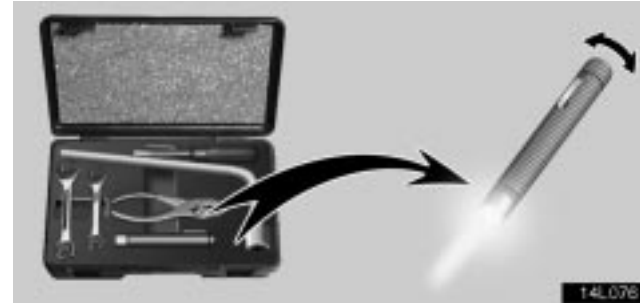

The penlight is in the tool box on the left side of the trunk.

- Battery insertion: Insert the batteries into the penlight. (The penlight terminals have no + or - end, but be sure to insert both batteries facing the same direction.)
- To turn the penlight on, turn the penlight head.
- To turn it off, turn the penlight head further in the same direction or turn it in the reverse direction.

COOL BOX



The cool box is designed for holding canned drinks. Do not use this box to store drinks in plastic or disposable containers, or bottles—they might spill or break. Do not store any food that might go bad or smell in this box. Do not place any food on the box.

The cool box system will activate whenever the rear air conditioning is on.

To use the cool box:

1. Pull the band of the center armrest forward and down.



2. Pull the lever on top of the lid and push down.



The cool box system can be turned off by closing the cool air intake lid shown in the illustration. At this time, although you can use the box as an auxiliary box, note that cool air might flow inside.

Open the cool air intake lid when using it as a cool box.

INTERIOR EQUIPMENT

CAUTION

To reduce the chance of injury in case of an accident or sudden stop while driving, always keep the cool box closed when it is not in use.

FLOOR MAT

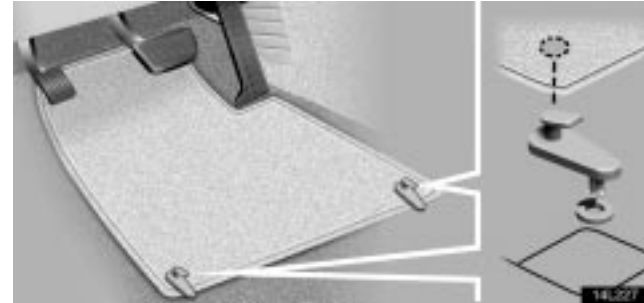

Use a floor mat of the correct size.

If the floor carpet and floor mat have 2 holes, then they are designed for use with locking clips. Fix the floor mat with locking clips into the holes in the floor carpet.



⚠ CAUTION

Make sure the floor mat is properly placed on the floor carpet. If the floor mat slips and interferes with the movement of the pedals during driving, it may cause an accident.

COAT HOOKS



► *Vehicles with rear air conditioning controls*



► *Vehicles without rear air conditioning controls*

To use the coat hook, push the hook.

INTERIOR EQUIPMENT

CAUTION

Do not hook a hanger, heavy or sharp pointed object on the coat hook. If the curtain shield airbag inflates, those items will be hurled away with great force or the curtain shield airbag may not activate correctly. When you hang clothes, hang them on the coat hook directly.

SUNSHADES



► *Type A (Rear electric sunshade and manual sunshades)*



► *Type B (Rear electric sunshade only)*

Rear electric sunshade



To raise the rear electric sunshade, push the switch. To lower the shade, push the same switch again.

The sunshade works when the ignition switch is in the "ON" position.

When the selector lever is shifted into the "R" position while the sunshade is raised, the sunshade will be automatically lowered.

To raise the sunshade again, perform any of the following operations:

- Shift the selector lever into the "P" position.
- Push the switch again.
- Move the selector lever out of "R" position and drive your vehicle over 15 km/h (9 mph).

Key off operation: Even after the ignition switch is turned to the "ACC" or "LOCK" position, the sunshade can be operated for about 60 seconds.

 CAUTION
<ul style="list-style-type: none"> ● Do not touch the brackets fastening the shade to avoid injuring your fingers or hands. ● Do not put your fingers in the shade groove while the shade is operating to avoid getting them caught or injured by the runner.

NOTICE
<ul style="list-style-type: none"> ● <i>To prevent the vehicle battery from being discharged, always operate the shade while the engine is running.</i> ● <i>Observe the following to avoid damage and/or malfunction:</i> <i>Do not overload the shade motor and other parts (for instance by pushing down on the sunshade bracket while it is opening).</i> <i>Do not place anything where it may hinder the opening/closing of the shade.</i> <i>Do not affix anything to the shade.</i> <i>Clean the shade groove if there is any foreign matter or dust on it.</i> <i>Do not operate the rear electric sunshade repeatedly for a long time as its motor may overheat.</i>

INTERIOR EQUIPMENT

Manual sunshades

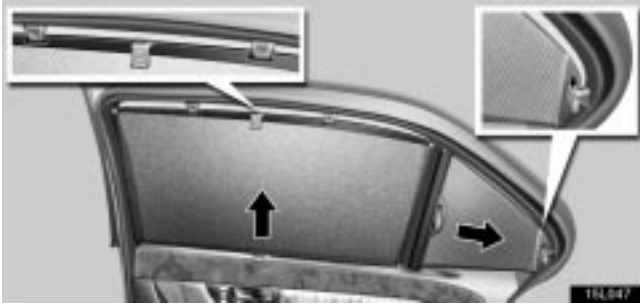

To use the sunshade, pull the tab of the sunshade upward or sideways and hook it as shown.

NOTICE

Do not place anything in the sunshade groove so it will not be damaged.

LUGGAGE NET

The luggage net is located in the trunk to secure the luggage.

The net is installed as follows:

Securing the luggage on the floor



1. Raise the front hooks on the vehicle front side.
2. Raise the rear hooks on the vehicle rear side. If the hooks are under the mat, slide the mat a little and raise the hooks.
3. Hook the net on the front hooks and then on the rear hooks.

Securing the luggage in the trunk



1. Raise the lower hooks on the vehicle front side.
2. Hook the luggage net on the lower hooks and then on the upper hooks.

NOTICE

- *Do not use the net to secure sharp or heavy objects. The net will tear off.*
- *Be sure not to twist the strap or net when hooking.*

FIRST-AID KIT NET

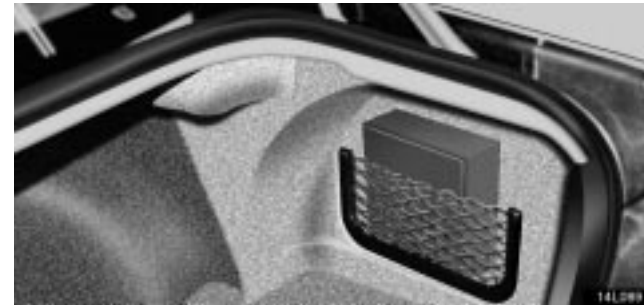

This net is designed to accommodate the first-aid kit.

Make sure the first-aid kit rests securely in the net.

SECTION 1-5

INSTRUMENTS AND CONTROLS

Exterior equipment

Hood	139
Trunk lid	140
Fuel tank cap	143
Moon roof	145

HOOD



1. To open the hood, pull the hood lock release lever under the instrument panel. The hood will spring up slightly.

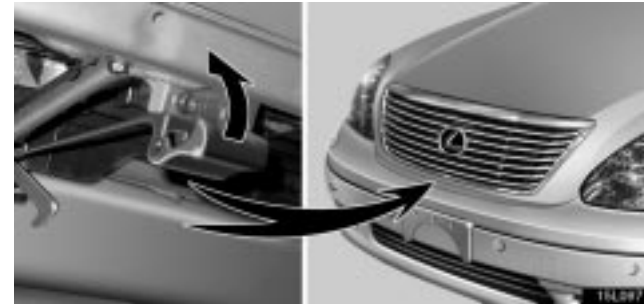

2. Insert your fingers under the hood, push up the auxiliary catch lever and lift the hood.

Before closing the hood, check to see that you have not forgotten any tools, rags, etc. Then lower the hood and make sure it locks.



CAUTION

Before driving, be sure that the hood is closed and locked securely. Otherwise, the hood may open unexpectedly while driving and an accident may occur.

EXTERIOR EQUIPMENT

TRUNK LID

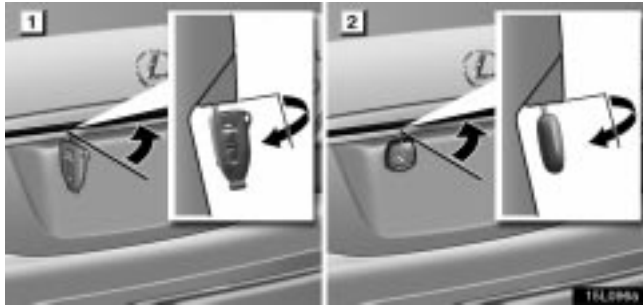

► **1** *Type A* **2** *Type B*

To unlock the trunk lid, insert the master key and turn it clockwise.

To close the trunk lid, lower it and press down on it. After closing the trunk lid, try pulling it up to make sure it is securely closed.

The trunk lid can be unlocked by pushing the trunk button or using the wireless remote control function. For details, see “Smart key system” on page 20 and “Wireless remote control” on page 36.

When you open the trunk, the lights illuminate the inside of the trunk and around your feet.

CAUTION

- Keep the trunk lid closed while driving. This not only prevents luggage from being thrown out, but also prevents exhaust gases from entering the vehicle.
- Always lock the trunk lid and all doors, and keep the vehicle keys out of children’s reach .
- Never leave children unattended in the vehicle. Unsupervised children may lock themselves in the vehicle or trunk and suffer serious injuries or death.

Trunk lid opener



- ▶ **1** Main switch **2** Operative **3** Inoperative

To open the trunk lid while sitting in the driver's seat, pull the lever with the main switch not pushed in.

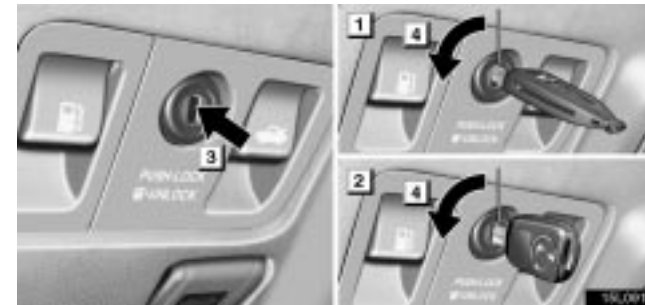

- ▶ **1** Type A **2** Type B
- 3** If you do not want to activate the trunk lid opener system, push in the main switch.
- 4** To activate the system, insert the master key and turn it counterclockwise.

To protect things put in the trunk, when you have your vehicle parked, push in the main switch.

EXTERIOR EQUIPMENT

Trunk lid closer

If the trunk lid is closed but does not latch shut, it automatically closes completely.

CAUTION

- Pay careful attention not to get your fingers trapped as the trunk lid automatically closes when the trunk has not been fully closed.
- Never allow a child to operate the trunk lid.

NOTICE

Do not apply excessive force when the trunk lid closer is operating. Doing so may damage the trunk lid closer.

Also, be careful not to leave the key inside the trunk.

Internal trunk release handle



If a person is locked in the trunk, he/she can pull down the phosphorescent handle on the inside of trunk lid to open the trunk lid.

The phosphorescent (glow-in-the-dark) handle will continue to glow for a time after the trunk lid is closed. Exposing the handle to stronger light will cause it to glow longer.

FUEL TANK CAP



The arrow head next to FUEL DOOR as shown indicates on which side of your vehicle the fuel filler door is located.



1. To open the fuel filler door, pull the lever under the instrument panel.

When refueling, turn off the engine.

CAUTION

- Do not smoke, cause sparks or allow open flames when refuelling. The fumes are flammable.
- When opening the cap, do not remove the cap quickly. In hot weather, fuel under pressure could cause injury by spraying out of the filler neck if the cap is suddenly removed.

EXTERIOR EQUIPMENT



2. To remove the fuel tank cap, turn the cap slowly counterclockwise, then pause slightly before removing it. The removed cap can be stored on the back side of the fuel filler door.

It is not unusual to hear a slight swoosh when the cap is opened. When installing the cap, turn the cap clockwise until you hear a click.

If the cap is not tightened securely, the malfunction indicator lamp comes on. Make sure the cap is tightened securely.

The indicator lamp goes off after driving several times. If the indicator lamp does not go off, contact your Lexus dealer as soon as possible.

CAUTION

- Make sure the cap is tightened securely to prevent fuel spillage in case of an accident.
- Use only a genuine Lexus fuel tank cap for replacement. It is designed to regulate fuel tank pressure.

NOTICE

To prevent damage to the cap, observe the following precautions.

- *Apply force only in the turning direction to the cap. Do not pull or pry it.*
- *Do not tighten the cap further after you hear one click when installing.*

In case the opener is not actuated



Pull the manual lever located in the trunk toward the back.

This is used in case the fuel filler door cannot be opened due to a discharged battery or other trouble.

Refueling the vehicle

As soon as the correctly operated nozzle switches off automatically for the first time, the tank is full. Do not try to add more fuel, because fuel may spill out.

MOON ROOF



► **1** Open **2** Close

To slide open the moon roof, push the slide control switch toward the back for about 1 second. The moon roof will open and stop partway 30 mm (1.2 in.) from the fully opened position. When you push the switch once again, the moon roof will fully open. To stop partway, push the same side or the "TILT" switch.

As driving with the moon roof opened fully will cause wind throbs, we recommend you to drive with the moon roof partway 30 mm (1.2 in.) from the fully opened position.

To operate the moon roof, the ignition switch must be in the "ON" position.

The sunshade can be opened or closed manually. However, if you open the moon roof, the sunshade will be opened with the moon roof.

EXTERIOR EQUIPMENT

To close the moon roof, push the slide control switch toward the front for about 1 second. The moon roof will fully close. To stop partway, push the same switch or push the “TILT” switch.



► **1** Tilt up **2** Lower

To tilt up the moon roof, push the “TILT” switch on the rear side. The moon roof will fully tilt up. To stop partway, push either side of the “TILT” switch.

To lower the moon roof, push the “TILT” switch on the front side. The moon roof will be fully lowered. To stop partway, push either side of the “TILT” switch.

To operate the moon roof, the ignition switch must be in the “ON” position.

Key off operation: Even if the ignition switch is turned to the “ACC” or “LOCK” position, the moon roof can be operated until any of the doors is opened (or for about 45 seconds).

Operating the moon roof from outside the vehicle

The moon roof can be closed or opened using a key.*

NOTE:

** This feature can be deactivated, or sliding open or tilting up can be selected.*

Ask your Lexus dealer for details.

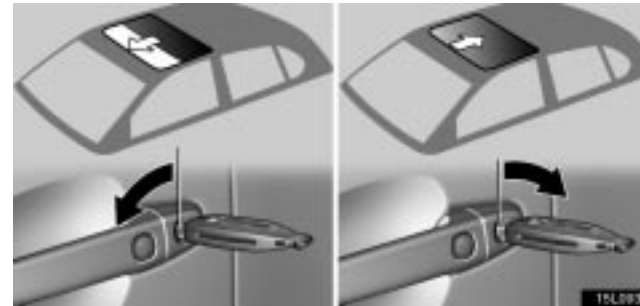

► *Type A*

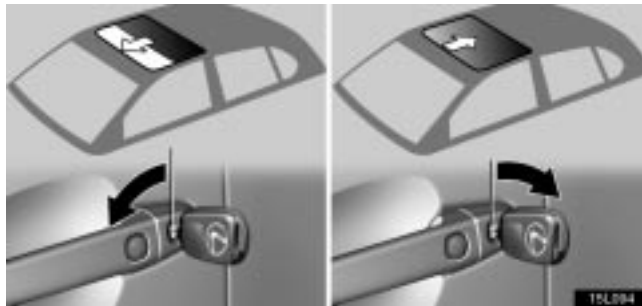

► **Type B**

Insert the key into the key hole on the driver's door.

To close the moon roof: Turn the key in the locking direction and hold it.

After the door is locked, the moon roof begins to close. To stop in the middle, return the key.

To slide open the moon roof: Turn the key in the unlocking direction and hold it.

After the door is unlocked, the moon roof begins to open. To stop in the middle, return the key.

Jam protection function

During closing operation, the moon roof stops and is open if something gets caught into the roof opening.

If the moon roof receives a strong impact, this function may work even if nothing is caught.

⚠ CAUTION

To avoid serious personal injury, you must do the following.

- While the vehicle is moving, always keep the heads, hands and other parts of the bodies of all occupants away from the roof opening. Otherwise, they could be seriously injured if the vehicle stops suddenly or if the vehicle is involved in an accident.
- Before you close the moon roof, always make sure there is nobody around the moon roof. You must also make sure nobody places his or her head, hands and other parts of the body in the roof opening. If someone's neck, head or hands get caught in the closing roof, it could result in a serious injury. When anyone closes the moon roof, first make sure it is safe to do so.
- Be sure to remove the ignition key or turn the ignition switch to the "LOCK" position when you leave your vehicle.

EXTERIOR EQUIPMENT

- Never leave anyone (particularly a small child) alone in your vehicle, especially with the ignition key still inserted or with the ignition switch in a position other than "LOCK". Otherwise, he/she could use the moon roof switches and get trapped in the roof opening. Unattended person (particularly a small child) can be involved in a serious accident.
- Never sit on top of the vehicle around the roof opening.
- Never try jamming any part of your body to activate the jam protection function intentionally.
- The jam protection function may not work if something gets caught just before the moon roof is fully closed.

·
-

SECTION 1 – 6

INSTRUMENTS AND CONTROLS

Occupant restraint systems

Seats	151
Front seats	151
Rear seats	159
Armrest	161
Head restraints	162
Seat belts	165
SRS driver airbags and front passenger airbags	176
SRS side airbags and curtain shield airbags	187
Child restraint	196
Driving position memory system	217
Rear seat position memory system	221

SEATS

While the vehicle is being driven, all vehicle occupants should have the seatback upright, sit well back in the seat and properly wear the seat belts provided.

CAUTION

- Do not drive the vehicle unless the occupants are properly seated. Do not allow any passengers to sit in the luggage compartment or cargo area. Persons not properly seated and/or not properly restrained by seat belts can be severely injured in the event of emergency braking or a collision.
- During driving, do not allow any passengers to stand up or move around between seats. Otherwise, severe injuries can occur in the event of emergency braking or a collision.

FRONT SEATS

Front seat precautions

Driver seat

CAUTION

The SRS driver airbag deploys with considerable force, and can cause death or serious injury especially if the driver is very close to the airbag. The National Highway Traffic Safety Administration (“NHTSA”) advises:

Since the risk zone for driver airbag is the first 50-75 mm (2-3 in.) of inflation, placing yourself 250 mm (10 in.) from your driver airbag provides you with a clear margin of safety. This distance is measured from the center of the steering wheel to your breastbone. If you sit less than 250 mm (10 in.) away now, you can change your driving position in several ways:

- Move your seat to the rear as far as you can while still reaching the pedals comfortably.
- Slightly recline the back of the seat. Although vehicle designs vary, many drivers can achieve the 250 mm (10 in.) distance, even with the driver seat all the way forward, simply by reclining the back of the seat somewhat. If reclining the back of your seat makes it hard to see the road, raise yourself by using a firm, non-slippery cushion, or raise the seat if your vehicle has that feature.

OCCUPANT RESTRAINT SYSTEMS

- If your steering wheel is adjustable, tilt it downward. This points the airbag toward your chest instead of your head and neck.

The seat should be adjusted as recommended by NHTSA above, while still maintaining control of the foot pedals, steering wheel, and your view of the instrument panel controls.

Front passenger seat



CAUTION

The SRS front passenger airbag also deploys with considerable force, and can cause death or serious injury especially if the front passenger is very close to the airbag. The front passenger seat should be as far from the airbag as possible with the seatback adjusted, so the front passenger sits upright.

Front seats



CAUTION

The SRS side airbags are installed in the driver and front passenger seats. Observe the following precautions.

- Do not lean against the front door when the vehicle is in use, since the side airbag inflates with considerable speed and force. Otherwise, you may be killed or severely injured.
- Do not use seat accessories which cover the area where the side airbags inflate. Such accessories may prevent the side airbags from activating correctly, causing death or serious injury.
- Do not modify or replace the seats or the upholstery of the seats equipped with side airbags. Such change may prevent the side airbag system from activating correctly, disable the system, or cause the side airbags to inflate accidentally, resulting in death or serious injury.

Seat adjustment precautions

CAUTION

- Do not adjust the seat while the vehicle is moving as the seat may unexpectedly move and cause the driver to lose control of the vehicle.
- Be careful that the seat does not hit a passenger, luggage or the rear seat.

NOTICE

Do not operate the control switch in more than one dimension at a time. It may cause electrical overload.

Adjusting front seats



- ▶ **1** Seat cushion length control switch
- 2** Seat position control switch, seat cushion angle and height control switch
- 3** Seatback angle and head restraint control switch
- 4** Upper lumbar support control switch
- 5** Lower lumbar support control switch

OCCUPANT RESTRAINT SYSTEMS

Adjusting seat cushion length



► *For driver's seat only*

Move the control switch in the desired direction.

Releasing the switch will stop the seat cushion in that position. Do not place anything under the seat, as this might interfere with the seat movement.

Adjusting seat position

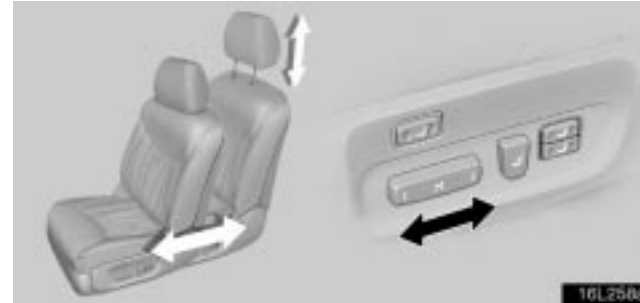

► *For driver's seat*

Move the control switch in the desired direction.

Releasing the switch will stop the seat and head restraint in that position. Do not place anything under the seat, as this might interfere with the seat movement.

You can adjust the head restraint in the desired position by using the head restraint control switch. However, if you move the seat more than 15 mm (0.6 in.) by using the seat position control switch after adjusting the head restraint, the head restraint will return to the designated position as determined by the seat position switch. To adjust the head restraint, see "Head restraints" on page 162.

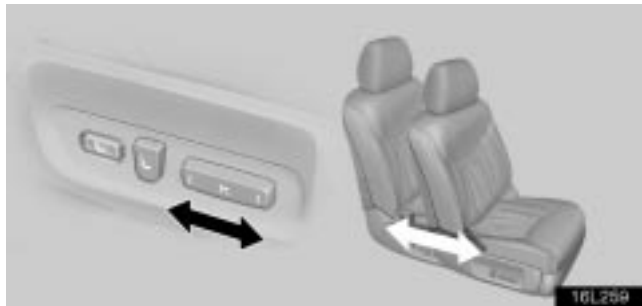

► *For passenger's seat*

Move the control switch in the desired direction.

Releasing the switch will stop the seat in that position. Do not place anything under the seat as this might interfere with the seat movement.

Adjusting seatback angle

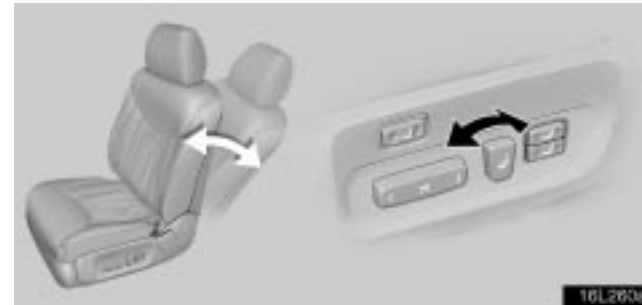

Move the control switch in the desired direction.

Releasing the switch will stop the seatback in that position.



CAUTION

To reduce the risk of sliding under the lap belt during a collision, avoid reclining the seatback any more than needed. The seat belts provide maximum protection in a frontal or rear collision when the driver and the front passenger are sitting up straight and well back in the seats. If you are reclined, the lap belt may slide past your hips and apply restraint forces directly to the abdomen. In the event of a frontal collision, the more the seat is reclined, the greater the risk of personal injury.

OCCUPANT RESTRAINT SYSTEMS

Adjusting seat cushion angle and height



Move the control switch in the desired direction.

Releasing the switch will stop the seat cushion in that position.

Adjusting lumbar support

Driver's seat (Upper and lower lumbar supports)

To use both lumbar supports effectively, adjust the lower lumbar support first and then the upper lumbar support.



► *Lower lumbar support*

Push the lower lumbar support control switch on either side.

The amount of lower lumbar support will change while the switch is pushed.

OCCUPANT RESTRAINT SYSTEMS



► *Upper lumbar support*

Push the upper lumbar support control switch on either side.

The amount of upper lumbar support will change while the switch is pushed.

Front passenger's seat



Push the control switch on either side.

The amount of lumbar support will change while the switch is pushed.

OCCUPANT RESTRAINT SYSTEMS

Adjusting front passenger's seat from the driver's seat

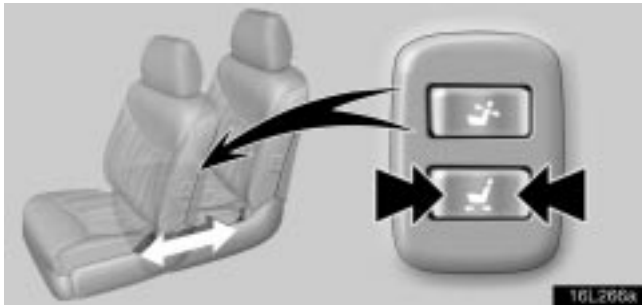

► **Seat position**

Move the control switch in the desired direction.

Releasing the switch will stop the seat in that position. Do not place anything under the seat as this might interfere with the seat movement.



CAUTION

If you operate the switch when a front passenger is seated or he/she is getting on or off the front passenger seat, take full safety precautions beforehand by telling the occupant that the seat is about to move.

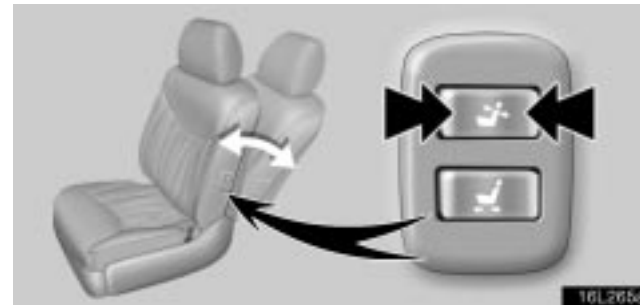

► **Seatback angle**

Move the control switch in the desired direction.

Releasing the switch will stop the seatback in that position.

⚠ CAUTION

- If you operate the switch when an occupant is seated or when he/she is getting on or off the front passenger seat, take full safety precautions beforehand by telling the occupant that the seat is about to move.
- To reduce the risk of sliding under the lap belt during a collision, avoid reclining the seatback any more than needed. The seat belts provide maximum protection in a frontal or rear collision when the front passenger is sitting up straight and well back in the seats. If he/she is reclined, the lap belt may slide past his/her hips and apply restraint forces directly to the abdomen. In the event of a frontal collision, the more the seat is reclined, the greater the risk of personal injury.

REAR SEATS

Adjusting rear power seats



- ▶ **1** *Seat position control switches*
- ▶ **2** *Head restraint height control switches*
- ▶ **3** *Refreshing rear seat switches*

The rear power seat control switches are located in the rear armrest.

For the operation of head restraints and refreshing rear seat switches, see “Head restraints” on page 162 and “Refreshing rear seat switches” on page 76.

OCCUPANT RESTRAINT SYSTEMS

Adjusting seat position



► **1** For left seat **2** For right seat

Push the seat position control switch on the front side to move the seat forward and on the rear side to move the seat backward.

Releasing the switch will stop the seat in that position. Do not place anything under the seat as this might interfere with the seat movement.

Returning the rear seats and rear head restraints from the front seats



To return the rear seats and rear head restraints, push the switch on the instrument panel. The rear seats move backward and the rear head restraints move downward while the switch is being pushed.

CAUTION

- Do not operate the switch when the rear seats and head restraints are in the rearmost and lowest positions. The system may malfunction.
- If you operate the switch when an occupant is seated or when he/she is getting on or off the rear seat, take full safety precautions beforehand by telling the occupant that the seat is about to move.

ARMREST

To use the armrest, pull it down as shown above.



► *Vehicles with rear power seats*



► *Vehicles without rear power seats*

NOTICE

To prevent damage to the armrest, avoid putting heavy loads on it.

OCCUPANT RESTRAINT SYSTEMS

HEAD RESTRAINTS

For your safety and comfort, adjust the head restraint before driving.

Front seats



Move the control switch in the desired direction.

Releasing the switch will stop the head restraint in that position.

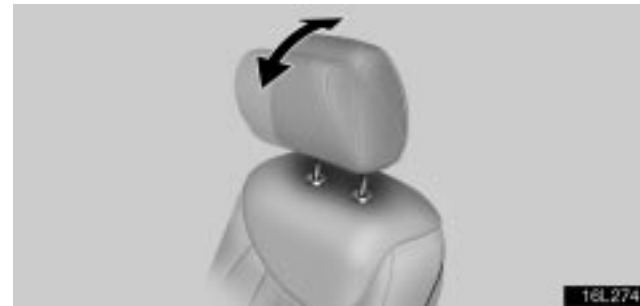

To move the head restraint forward or rearward, pull or push on the top.

The head restraint is most effective when it is close to your head. Therefore, using a cushion on the seatback is not recommended.

⚠ CAUTION

Adjust the center of the head restraint so that it is closest to the top of your ears.

Outside rear seats (power type)

Adjusting head restraint height

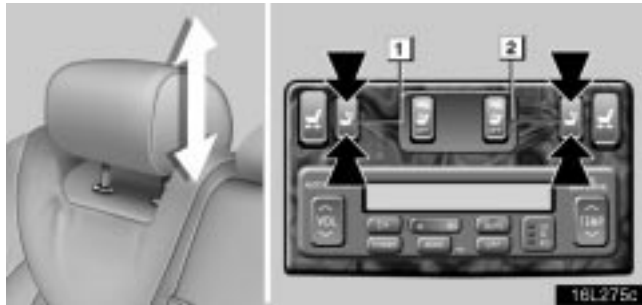

► **1** For left seat **2** For right seat

Push the head restraint height control switch on the front side to move the head restraint upward and on the rear side to move it downward.

Releasing the switch will stop the head restraint in that position.

CAUTION
Adjust the center of the head restraint so that it is closest to the top of your ears.

Outside rear seats (manual type)

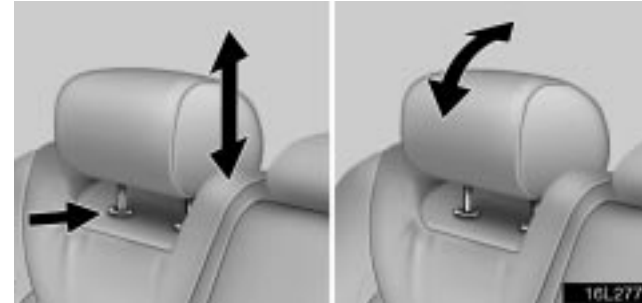

To raise the head restraint, pull it up. To lower it, press the lock release button and push the head restraint down. To move the head restraint forward or rearward, pull or push on the top.

The head restraint is most effective when it is close to your head. Therefore, using a cushion on the seatback is not recommended.

CAUTION

- Adjust the center of the head restraint so that it is closest to the top of your ears.
- After adjusting the head restraint, make sure it is locked in position.
- Do not drive with the head restraints removed.

OCCUPANT RESTRAINT SYSTEMS

Center rear seat

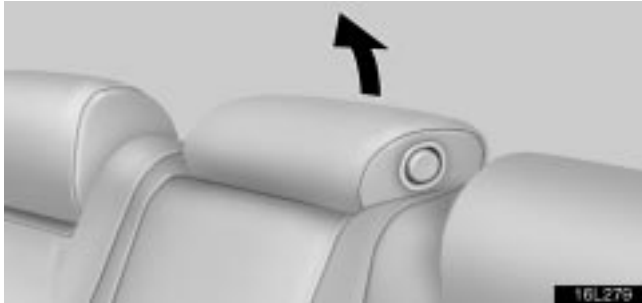

To move the head restraint forward, pull on the top. To move the head restraint forward or rearward, pull or push on the top.

The head restraint is most effective when it is close to your head. Therefore, using a cushion on the seatback is not recommended.



CAUTION

After adjusting the head restraint, make sure it is locked in position.



Push the button to return the head restraint to its original position.

SEAT BELTS

Seat belt precautions

Lexus strongly urges that the driver and passengers in the vehicle be properly restrained at all times with the seat belts provided. Failure to do so could increase the chance of injury and/or the severity of injury in accidents.

The seat belts provided for your vehicle are designed for people of adult size, large enough to properly wear them.

Child. Use a child restraint system appropriate for the child until the child becomes large enough to properly wear the vehicle's seat belts. See "Child restraint" on page 196 for details.

If a child is too large for a child restraint system, the child should sit in the rear seat and must be restrained using the vehicle's seat belt. According to accident statistics, the child is safer when properly restrained in the rear seat than in the front seat.

If a child must sit in the front seat, the seat belts should be worn properly. If an accident occurs and the seat belts are not worn properly, the force of the rapid inflation of the airbag may cause death or serious injury to the child.

Do not allow any children to stand up or kneel on either rear or front seats. An unrestrained child could suffer serious injury or death during emergency braking or a collision. Also, do not let the child sit on your lap. Holding a child in your arms does not provide sufficient restraint.

Pregnant woman. Lexus recommends the use of a seat belt. Ask your doctor for specific recommendations. The lap belt should be worn securely and as low as possible over the hips and not on the waist.

Injured person. Lexus recommends the use of a seat belt. Depending on the injury, first check with your doctor for specific recommendations.

CAUTION

Persons should ride in their seats properly wearing their seat belts whenever the vehicle is moving. Otherwise, they are much more likely to suffer serious bodily injury or death in the event of sudden braking or a collision.

When using the seat belts, observe the following:

- **Use the belt for only one person at a time. Do not use a single belt for two or more people - even children.**
- **To reduce the risk of sliding under the lap belt during a collision, avoid reclining the seatback any more than needed. The seat belts provide maximum protection in a frontal or rear collision when the driver and the front passenger are sitting up straight and well back in the seats. If you are reclined, the lap belt may slide past your hips and apply restraint forces directly to the abdomen. In the event of a frontal collision, the more the seat is reclined, the greater the risk of personal injury.**

OCCUPANT RESTRAINT SYSTEMS

- Be careful not to damage the belt webbing or hardware. Take care that they do not get caught or pinched in the seat or doors.
- Inspect the belt system periodically. Check for cuts, fraying, and loose parts. Damaged parts should be replaced. Do not disassemble or modify the system.
- Keep the belts clean and dry. If they need cleaning, use a mild soap solution or lukewarm water. Never use bleach, dye, or abrasive cleaners, or allow them to come into contact with the belt - they may severely weaken the belts. (See "Cleaning the interior" on page 524 for instructions.)
- Replace the belt assembly (including bolts) if it has been used in a severe impact. The entire assembly should be replaced even if damage is not obvious.

Front seat belt buckle illumination



Opening the driver's door lights up the driver's seat belt buckle for easy use. The same applies for the front passenger's door and seat belt buckle.

The light remains on for 15 seconds after the door is closed, but goes off immediately when all the doors are locked.

OCCUPANT RESTRAINT SYSTEMS

Fastening front and rear seat belts

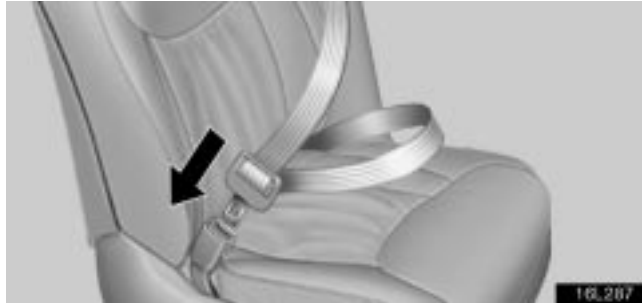

Adjust the seat as needed and sit up straight and well back in the seat. To fasten your belt, pull it out of the retractor and insert the tab into the buckle.

You will hear a click when the tab locks into the buckle.

The seat belt length automatically adjusts to your size and the seat position.

The retractor will lock the belt during a sudden stop or on impact. It also may lock if you lean forward too quickly. A slow, easy motion will allow the belt to extend, and you can move around freely.

When a passenger's shoulder belt is completely extended and is then retracted even slightly, the belt is locked in that position and cannot be extended. This feature is used to hold the child restraint system securely. (For details, see "Child restraint" on page 196.) To free the belt again, fully retract the belt and then pull the belt out once more.

If the seat belt cannot be pulled out of the retractor, firmly pull the belt and release it. You will then be able to smoothly pull the belt out of the retractor.



CAUTION

- After inserting the tab, make sure the tab and buckle are locked and that the belt is not twisted.
- Do not insert coins, clips, etc. in the buckle as this may prevent you from properly latching the tab and buckle.
- If the seat belt does not function normally, immediately contact your Lexus dealer. Do not use the seat until the seat belt is fixed, because it cannot protect an adult occupant or your child from injury.

OCCUPANT RESTRAINT SYSTEMS



Adjust the position of the lap and shoulder belts.

- 1 Position the lap belt as low as possible on your hips - not on your waist.
- 2 Adjust it to a snug fit by pulling the shoulder portion upward through the latch plate.



CAUTION

- Both high-positioned lap belts and loose-fitting belts could cause serious injuries due to sliding under the lap belt during a collision or other unintended event. Keep the lap belt positioned as low on hips as possible.
- Do not place the shoulder belt under your arm.



► Front seat belts only

Adjust the shoulder anchor position to your size.

To adjust the shoulder anchor position, press the upper or lower part of the control switch located on the door. When the switch is released, the shoulder anchor will stop at that position.



CAUTION

Always make sure the shoulder belt is positioned across the center of your shoulder. The belt should be kept away from your neck, but not falling off your shoulder. Failure to do so could reduce the amount of protection in an accident and cause serious injuries in a collision.

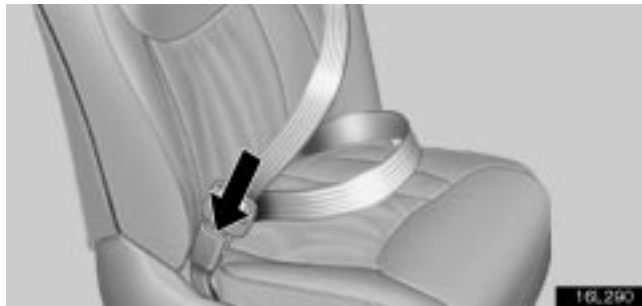

To release the belt, press the buckle release button and allow the belt to retract.

If the belt does not retract smoothly, pull it out and check for kinks or twists. Then make sure it remains untwisted as it retracts.

Seat belt comfort guides

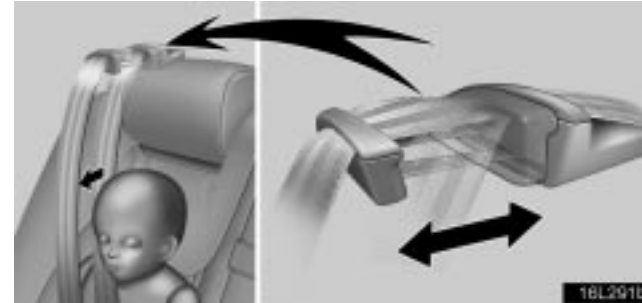

The seat belt comfort guides are installed on the outside rear seats to relieve uncomfortableness from the shoulder belt when it is applied closer to a child's neck (at the age of 10 or so), by pulling the shoulder belt a little forward.

Slide the seat belt comfort guide forward to adjust the shoulder belt.

The seat belt comfort guide should not be in the forward position for other purposes.

OCCUPANT RESTRAINT SYSTEMS

CAUTION

Always make sure the shoulder belt is positioned across the center of the child's shoulder. The belt should be kept away from the child's neck, and should not fall off the child's shoulder. Failure to observe these precautions could reduce the effectiveness of the seat belt in an accident, causing death or serious injury.

Seat belt extender

If your seat belts cannot be fastened securely because they are not long enough, a personalized seat belt extender is available from your Lexus dealer free of charge.

Please contact your local Lexus dealer so that the dealer can order the proper required length for the extender. Bring the heaviest coat you expect to wear for proper measurement and selection of length. Additional ordering information is available at your Lexus dealer.

CAUTION

When using the seat belt extender, observe the following precautions. Failure to follow these instructions could reduce the effectiveness of the seat belt restraint system in case of an accident, increasing the chance of personal injury.

- Remember that the extender provided for you may not be safe when used on a different vehicle, for another person, or at a different seating position than the one originally intended.

OCCUPANT RESTRAINT SYSTEMS



- If the seat belt extender has been connected to the driver's seat belt buckle without wearing the seat belt when using the extender in the driver's seat, the SRS driver's airbag system will judge that the driver wears the seat belt even if not wearing it. In this case, the driver's airbag may not activate correctly, causing death or serious injury in the event of collision. Be sure to wear the seat belt with the seat belt extender.

- Be sure to wear the seat belt without the seat belt extender if you can fasten the seat belt without the extender.
- Do not use the seat belt extender when installing a child restraint system on the front or rear passenger seat. If installing a child restraint system with the seat belt extender connected to the seat belt, the seat belt will not securely hold the child restraint system, which could cause death or serious injury to the child or other passengers in the event of collision.

OCCUPANT RESTRAINT SYSTEMS



To connect the extender to the seat belt, insert the tab into the seat belt buckle so that the “PRESS” signs on the buckle release buttons of the extender and the seat belt are both facing outward as shown.

You will hear a click when the tab locks into the buckle.

When releasing the seat belt, press on the buckle release button on the extender, not on the seat belt. This helps prevent damage to the vehicle interior and extender itself.

When not in use, remove the extender and store in the vehicle for future use.

CAUTION

- After inserting the tab, make sure the tab and buckle are locked and that the lap and shoulder portions of the belt and the seat belt extender are not twisted.
- Do not insert coins, clips, etc. in the buckle as this may prevent you from properly latching the tab and buckle.
- If the seat belt does not function normally, immediately contact your Lexus dealer. Do not use the seat until the seat belt is fixed, because it cannot protect an adult occupant or your child from injury.

Seat belt pretensioners



Both front seats and the two outside rear seats are equipped with seat belt pretensioners and are designed to be activated in response to a severe frontal impact.

When the sensor detects a severe frontal impact, the seat belts are quickly drawn back by the retractor so that the belts snugly restrain the seat occupants.

The front passenger seat belt pretensioner will not activate if there is no passenger sitting in the front passenger seat. However, the front passenger seat belt pretensioner may activate if luggage is put in the seat, or the seat belt is buckled up regardless of the presence of the occupant in the seat.

The outside rear seat belt pretensioners are activated even with no passengers in the outside rear seats.

The seat belt pretensioners and SRS airbags may not operate together in all collisions.

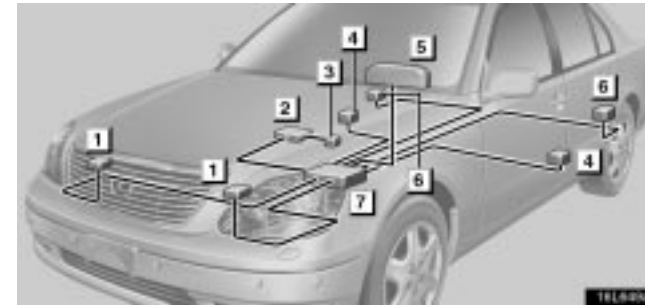

- ▶ **1 Front airbag sensors**
- 2 Occupant detection sensor**
- 3 Front passenger's seat belt buckle switch**
- 4 Front seat belt pretensioner assembly**
- 5 SRS warning light**
- 6 Rear seat belt pretensioner assembly**
- 7 Airbag sensor assembly**

The seat belt pretensioner system consists mainly of the above components, and their locations are shown in the illustration.

The seat belt pretensioners are controlled by the airbag sensor assembly. The airbag sensor assembly consists of a safing sensor and airbag sensor.

OCCUPANT RESTRAINT SYSTEMS

When the seat belt pretensioners are activated, an operating noise may be heard and a small amount of non-toxic gas may be released. This does not indicate that a fire is occurring. This gas is normally harmless.

Once the seat belt pretensioners have been activated, the seat belt retractors remain locked.



CAUTION

Do not modify, remove, strike or open the seat belt pretensioner assemblies, airbag sensor or surrounding area or wiring. Failure to follow these instructions may prevent the seat belt pretensioners from activating correctly, cause sudden operation of the system or disable the system, which could result in death or serious injury. Consult your Lexus dealer about any repair and modification.

NOTICE

Do not perform any of the following changes without consulting your Lexus dealer. Such changes can interfere with proper operation of the seat belt pretensioners in some cases.

- *Installation of electronic devices such as a mobile two-way radio, cassette tape player or compact disc player.*
- *Repairs on or near the seat belt retractor assemblies.*
- *Modification of the suspension system.*
- *Modification of the front end structure.*
- *Attachment of a grille guard (bull bar, kangaroo bar, etc.), snowplow, winches or any other equipment to the front end.*
- *Repairs made on or near the front fenders, front end structure or console.*

OCCUPANT RESTRAINT SYSTEMS



This indicator comes on when the ignition switch is turned to the “ON” position. It goes off after about 6 seconds. This means the seat belt pretensioners are operating properly.

This warning light system monitors the airbag sensor assembly, front airbag sensors, side and curtain shield airbag sensor assemblies, curtain shield airbag sensor assemblies, driver’s seat position sensor, driver’s seat belt buckle switch, occupant detection sensor, front passenger’s seat belt buckle switch, seat belt pretensioner assemblies, inflators, warning light, interconnecting wiring and power sources. (For details, see “Service reminder indicators and warning buzzers” on page 81.)

If any of the following conditions occurs, this indicates a malfunction of the airbags or seat belt pretensioners. Contact your Lexus dealer as soon as possible.

- When the ignition switch is turned to the “ON” position, the light does not come on or remains on.
- The light comes on while driving.
- If any seat belt does not retract or cannot be pulled out due to a malfunction or activation of the relevant seat belt pretensioner.
- The seat belt pretensioner assembly or surrounding area has been damaged.

OCCUPANT RESTRAINT SYSTEMS

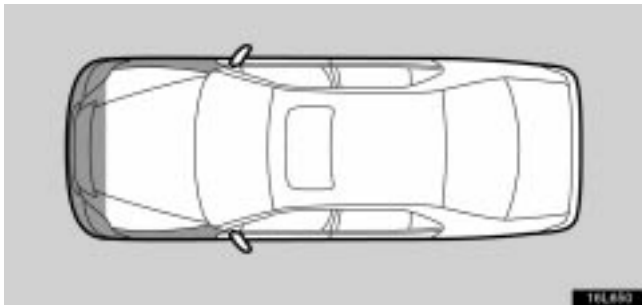

In the following cases, contact your Lexus dealer as soon as possible.

- The front of the vehicle (shaded in the illustration) was involved in an accident that was not severe enough to cause the seat belt pretensioners to operate.
- The seat belt pretensioner assembly or surrounding area is scratched, cracked, or otherwise damaged.

SRS DRIVER AIRBAGS AND FRONT PASSENGER AIRBAGS

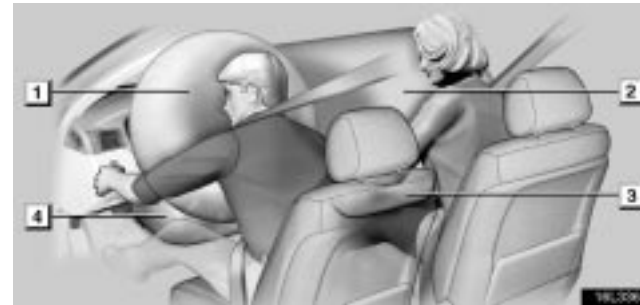

- **1** Driver airbag **2** Front passenger airbag
3 Front passenger knee airbag **4** Driver knee airbag

The SRS (Supplemental Restraint System) front airbags are designed to provide further protection for the driver and front passenger in addition to the primary safety protection provided by the seat belts.

In response to a severe frontal impact, the SRS front airbags work together with the seat belts to help reduce injury by inflating. The SRS front airbags help reduce injuries mainly to the driver's or front passenger's head, chest or knees caused by hitting the vehicle interior.

OCCUPANT RESTRAINT SYSTEMS

The SRS front passenger airbag will not activate if there is no passenger sitting in the front passenger seat. However, the front passenger airbag may deploy if luggage is put in the seat, or the seat belt is buckled up, regardless of the presence of an occupant in the seat.

Always wear your seat belt properly.

Your vehicle is equipped with a crash sensing and diagnostic module, which will record the use of the seat belt restraint system by the driver and front passenger when the SRS front airbags are inflated.



CAUTION

- **The SRS front airbag system is designed only as a supplement to the primary protection of the driver and front passenger seat belt systems. The driver and front passenger can be killed or seriously injured by the inflating airbags if they do not wear the available seat belts properly. During sudden braking just before a collision, an unrestrained driver or front passenger can move forward into direct contact with or close proximity to the airbag which may then deploy during the collision. To ensure maximum protection in an accident, the driver and all passengers in the vehicle must wear their seat belts properly. Wearing a seat belt properly during an accident reduces the chances of death or serious injury or being thrown out of the vehicle. For instructions and precautions concerning the seat belt system, see “Seat belts” on page 165.**

OCCUPANT RESTRAINT SYSTEMS

- Improperly seated and/or restrained infants and children can be killed or seriously injured by the deploying airbags. An infant or child who is too small to use a seat belt should be properly secured using a child restraint system. Lexus strongly recommends that all infants and children be placed in the rear seat of the vehicle and properly restrained. The rear seat is the safest for infants and children. For instructions concerning the installation of a child restraint system, see "Child restraint" on page 196 .

The SRS front airbags are designed to deploy in severe (usually frontal) collisions where the magnitude and duration of the forward deceleration of the vehicle exceeds the designed threshold level.

The SRS front airbags will deploy if the severity of the impact is above the designed threshold level, comparable to an approximate 25 km/h (15 mph) collision when the vehicle has the impact straight into a fixed barrier that does not move or deform.

However, this threshold velocity will be considerably higher if the vehicle strikes an object, such as a parked vehicle or sign pole, which can move or deform on impact, or if the vehicle is involved in an underride collision (e.g. a collision in which the front of the vehicle "underrides", or goes under, the bed of a truck, etc.).

It is possible that in some collisions where the forward deceleration of the vehicle is very close to the designed threshold level, the SRS front airbags and the seat belt pretensioners may not activate together.

Always wear your seat belts properly.

OCCUPANT RESTRAINT SYSTEMS

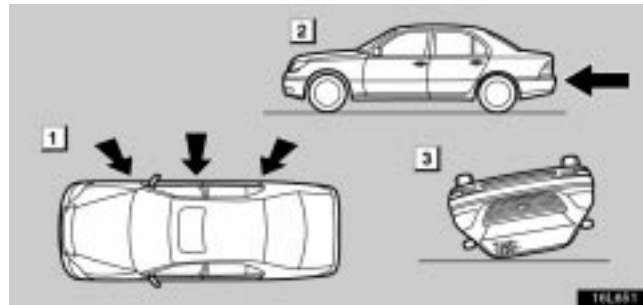

- ▶ **1** Collision from the side
- ▶ **2** Collision from the rear
- ▶ **3** Vehicle rollover

The SRS front airbags are generally not designed to inflate if the vehicle is involved in a side or rear collision, if it rolls over, or if it is involved in a low-speed frontal collision. But, whenever a collision of any type causes sufficient forward deceleration of the vehicle, deployment of the SRS front airbags may occur.

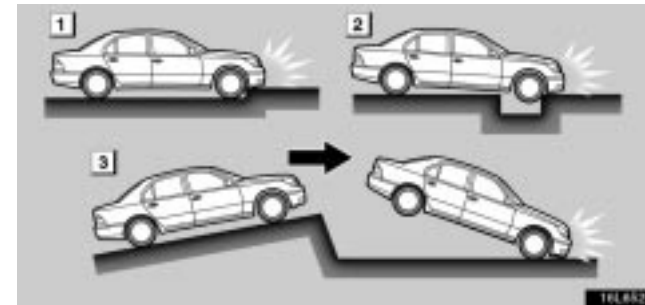

- ▶ **1** Hitting a curb, edge of pavement or hard surface
- ▶ **2** Falling into or jumping over a deep hole
- ▶ **3** Landing hard or vehicle falling

The SRS front airbags may also deploy if a serious impact occurs to the underside of your vehicle. Some examples are shown in the illustration.

OCCUPANT RESTRAINT SYSTEMS

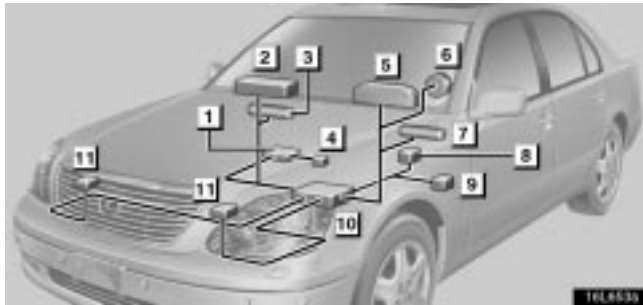

- ▶ **1 Occupant detection sensor**
- 2 Airbag module for front passenger (airbag and inflator)**
- 3 Knee airbag module for front passenger (airbag and inflator)**
- 4 Front passenger's seat belt buckle switch**
- 5 SRS warning light**
- 6 Airbag module for driver (airbag and inflator)**
- 7 Knee airbag module for driver (airbag and inflator)**
- 8 Driver's seat belt buckle switch**
- 9 Driver's seat position sensor**
- 10 Airbag sensor assembly**
- 11 Front airbag sensors**

The SRS front airbag system consists mainly of the above components, and their locations are shown in the illustration.

The airbag sensor assembly consists of a safing sensor and airbag sensors.

The front airbag sensors constantly monitor the forward deceleration of the vehicle. If an impact results in a forward deceleration beyond the designed threshold level, the system triggers the airbag inflators. At this time a chemical reaction in the inflators very quickly fills the airbags with non-toxic gas to help restrain the forward motion of the occupants. The front airbags then quickly deflate, so that there is no obstruction of the driver's vision should it be necessary to continue driving.

When the airbags inflate, they produce a loud noise and release some smoke and residue along with non-toxic gas. This does not indicate a fire. This smoke may remain inside the vehicle for some time, and may cause some minor irritation to the eyes, skin or breathing. Be sure to wash off any residue as soon as possible to prevent any potential skin irritation with soap and water. If you can safely exit from the vehicle, you should do so immediately.

OCCUPANT RESTRAINT SYSTEMS

Deployment of the airbags happens in a fraction of a second, so the airbags must inflate with considerable force. While the system is designed to reduce serious injuries, primarily to the head and chest, it may also cause other, less severe injuries to the face, chest, arms and hands. These are usually in the nature of minor burns or abrasions and swelling, but the force of a deploying airbag can cause more serious injuries, especially if an occupant's hands, arms, chest or head is in close proximity to the airbag module at the time of deployment. This is why it is important for the occupant to; avoid placing any object or part of the body between the occupant and the airbag module; sit straight and well back into the seat; wear the available seat belt properly; and sit as far as possible from the airbag module, while still maintaining control of the vehicle.

Parts of the airbag module (steering wheel hub, lower portion of instrument panel, airbag cover and inflator) may be hot for several minutes after deployment, so do not touch! The airbags inflate only once. The windshield may be damaged by absorbing some of the force of the inflating airbag.



CAUTION

The driver or front passenger who is too close to the steering wheel, lower portion of instrument panel or dashboard during airbag deployment can be killed or seriously injured. Lexus strongly recommends that:

- **The driver sit as far back as possible from the steering wheel while still maintaining control of the vehicle.**
- **The front passenger sit as far back as possible from the dashboard.**
- **All vehicle occupants be properly restrained using the available seat belts.**
- **If the seat belt extender has been connected to the driver's seat belt buckle without wearing the seat belt when using the extender in the driver's seat, the SRS driver's airbag system will judge that the driver wears the seat belt even if not wearing it. In this case, the driver's airbag may not activate correctly, causing death or serious injury in the event of collision. Be sure to wear the seat belt with the seat belt extender.**

For instructions and precautions concerning the seating position, see "Front seat precautions" on page 151.

OCCUPANT RESTRAINT SYSTEMS



- Do not sit on the edge of the seat or lean against the dashboard when the vehicle is in use, since the front passenger airbag could inflate with considerable speed and force. Anyone who is up against, or very close to, an airbag when it inflates, can be killed or seriously injured. Sit up straight and well back in the seat, and always use your seat belt properly.



- Lexus strongly recommends that all infants and children be placed in the rear seat of the vehicle and be properly restrained.
- Do not allow a child to stand up or kneel on the front passenger seat, since the front passenger airbag could inflate with considerable speed and force. Otherwise, the child may be killed or seriously injured.
- Do not hold a child on your lap or in your arms. Use a child restraint system in the rear seat. For instructions concerning the installation of a child restraint system, see “Child restraint” on page 196.

OCCUPANT RESTRAINT SYSTEMS



- Do not put anything or any part of your body on or in front of the dashboard, lower portion of instrument panel, steering wheel pad that houses the front airbag system or in the areas where the SRS knee airbags will inflate. They might restrict inflation or cause death or serious injury as they are projected rearward by the force of the deploying airbags. Likewise, the driver and front passenger should not hold objects in their arms or on their knees.
- If the vinyl cover is put on the area where the SRS knee airbag will deploy, be sure to remove it.

- Do not attach any objects except Lexus genuine parts in the area where the SRS knee airbag for the front passenger will inflate. When using an ashtray or auxiliary box on the front passenger's console box, be sure to keep it closed. The attached object, or opened ashtray or auxiliary box might restrict inflation of the airbag or be thrown away by the force of the deploying airbag, causing a danger.
- Do not modify or remove any wiring. Do not modify, remove, strike or open any components, such as the steering wheel pad, steering wheel, column cover, dashboard near the front passenger airbag, front passenger airbag cover, front passenger airbag, knee airbags or airbag sensor assembly. Doing so may prevent the front airbag system from activating correctly, cause sudden activation of the system or disable the system, which could result in death or serious injury.

Failure to follow these instructions can result in death or serious injury. Consult your Lexus dealer about any repair and modification.

OCCUPANT RESTRAINT SYSTEMS

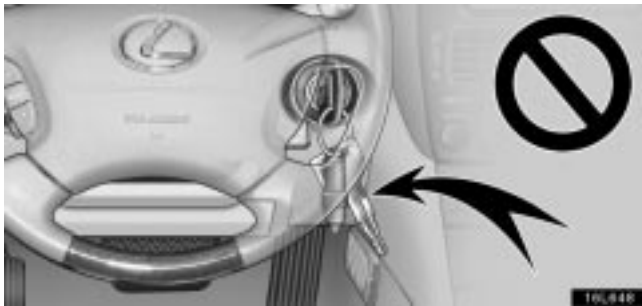

- Do not attach any heavy, sharp or hard objects such as keys or accessories to the ignition key. The objects may restrict the SRS knee airbag inflation or be thrust into the driver's seat area by the force of the deploying airbag, causing a danger.

NOTICE

Do not perform any of the following changes without consulting your Lexus dealer. Such changes can interfere with proper operation of the SRS front airbag system in some cases.

- *Installation of electronic devices such as a mobile two-way radio, cassette tape player or compact disc player.*
- *Modification of the suspension system.*
- *Modification of the front end structure.*
- *Attachment of a grille guard (bull bar, kangaroo bar, etc.), snowplow, winches or any other equipment to the front end.*
- *Repairs made on or near the front fenders, front end structure, console, steering column, steering wheel, lower portion of instrument panel or dashboard near the front passenger airbag.*

OCCUPANT RESTRAINT SYSTEMS



The indicator comes on when the ignition switch is turned to the “ON” position. It goes off after about 6 seconds. This means the SRS front airbags are operating properly.

This warning light system monitors the airbag sensor assembly, front airbag sensors, side and curtain shield airbag sensor assemblies, curtain shield airbag sensor assemblies, driver’s seat position sensor, driver’s seat belt buckle switch, occupant detection sensor, front passenger’s seat belt buckle switch, seat belt pretensioner assemblies, inflators, warning light, interconnecting wiring and power sources. (For details, see “Service reminder indicators and warning buzzers” on page 81.)

If any of the following conditions occurs, this indicates a malfunction of the airbags or seat belt pretensioners. Contact your Lexus dealer as soon as possible.

- When the ignition switch is turned to the “ON” position, the light does not come on or remains on.
- The light comes on while driving.

OCCUPANT RESTRAINT SYSTEMS

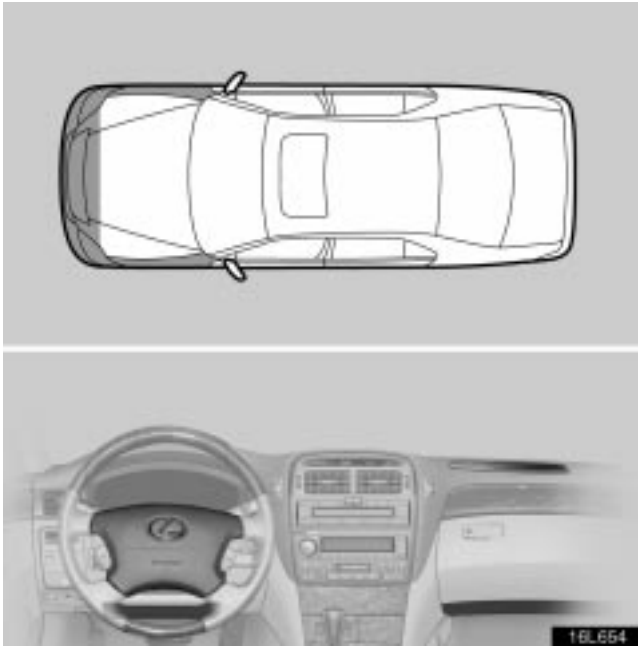

In the following cases, contact your Lexus dealer as soon as possible:

- The SRS front airbags have been inflated.
- The front of the vehicle (shaded in the illustration) was involved in an accident that was not severe enough to cause the SRS front airbags to inflate.

- The pad section of the steering wheel, front passenger airbag cover or lower portion of instrument panel (shaded in the illustration) is scratched, cracked, or otherwise damaged.

NOTICE

Do not disconnect the battery cables before contacting your Lexus dealer.

SRS SIDE AIRBAGS AND CURTAIN SHIELD AIRBAGS



► **1** *Curtain shield airbag* **2** *Side airbag*

The SRS (Supplemental Restraint System) side airbags and curtain shield airbags are designed to provide further protection for the driver, front passenger and rear outside passengers in addition to the primary safety protection provided by the seat belts.

In response to a severe side impact, the SRS side airbags and curtain shield airbags work with the seat belts to help reduce injury by inflating. The SRS side airbags help reduce injuries mainly to the driver's or front passenger's chest, and the SRS curtain shield airbags help reduce injuries mainly to the driver's, front passenger's or rear outside passenger's head.

The SRS side airbag on the passenger seat will not activate if there is no passenger sitting in the front passenger seat. However, the side airbag on the passenger seat may deploy if luggage is put in the seat, or the seat belt is buckled up, regardless of the presence of an occupant in the seat.

The SRS curtain shield airbags may activate even when the side airbags are not activated.

Always wear your seat belt properly.

Your vehicle is equipped with a crash sensing and diagnostic module, which will record the use of the seat belt restraint system by the driver and front passenger when the SRS side airbags and curtain shield airbags are inflated.

CAUTION

- The SRS side airbag and curtain shield airbag system is designed only as a supplement to the primary protection of the driver, front passenger and rear outside passenger seat belt systems. To ensure maximum protection in an accident, the driver and all passengers in the vehicle must wear their seat belts properly. Wearing a seat belt properly during an accident reduces the chances of death or serious injury or being thrown out of the vehicle. For instructions and precautions concerning the seat belt system, see "Seat belts" on page 165.

OCCUPANT RESTRAINT SYSTEMS

- Do not allow anyone to lean his/her head or any part of his/her body against the door or the area of the seat, front pillar, rear pillar or roof side rail from which the SRS side airbag and curtain shield airbag deploy even if he/she is a child seated in the child restraint system. It is dangerous if the SRS side airbag and curtain shield airbag inflate, and the impact of the deploying airbags could cause death or serious injury to the occupant.
- Improperly seated and/or restrained infants and children can be killed or seriously injured by the deploying airbags. An infant or child who is too small to use a seat belt should be properly secured using a child restraint system. Lexus strongly recommends that all infants and children be placed in the rear seats of the vehicle and properly restrained. The rear seats are the safest for infants and children. For instructions concerning the installation of a child restraint system, see "Child restraint" on page 196 .

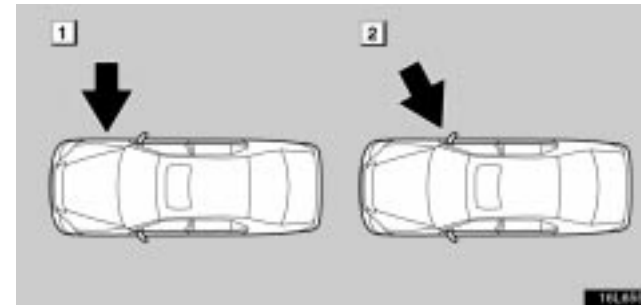

- ▶ **1** Collision from the side to the vehicle body other than the passenger compartment
- 2** Collision from the side at an angle

The SRS side airbag and curtain shield airbag system may not activate if the vehicle is subjected to a collision from the side at certain angles, or a collision to the side of the vehicle body other than the passenger compartment as shown in the illustration.

The SRS side airbags and curtain shield airbags are designed to inflate when the passenger compartment area suffers a severe impact from the side.

Always wear your seat belts properly.

OCCUPANT RESTRAINT SYSTEMS

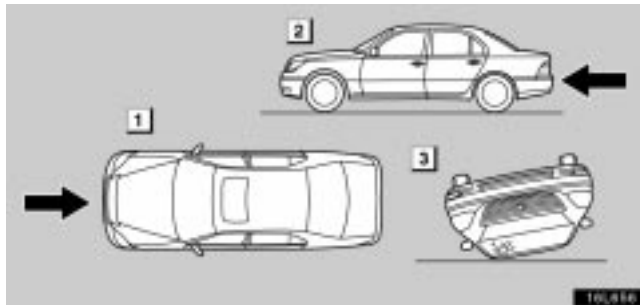

- ▶ **1** Collision from the front
- ▶ **2** Collision from the rear
- ▶ **3** Vehicle rollover

The SRS side airbags and curtain shield airbags are not generally designed to inflate if the vehicle is involved in a front or rear collision, if it rolls over, or if it is involved in a low-speed side collision.

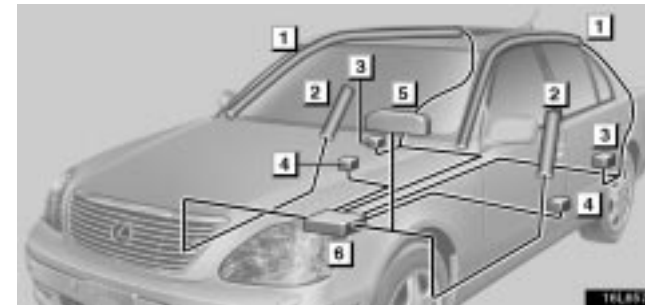

- ▶ **1** Curtain shield airbag module (airbag and inflator)
- ▶ **2** Side airbag module (airbag and inflator)
- ▶ **3** Curtain shield airbag sensor assembly
- ▶ **4** Side and curtain shield airbag sensor assembly
- ▶ **5** SRS warning light
- ▶ **6** Airbag sensor assembly

The SRS side airbag and curtain shield airbag system consists mainly of the above components, and their locations are shown in the illustration.

The SRS side airbag and curtain shield airbag system is controlled by the airbag sensor assembly. The airbag sensor assembly consists of a safing sensor and airbag sensor.

OCCUPANT RESTRAINT SYSTEMS

In a severe side impact, the side and curtain shield airbag sensor and/or the curtain shield airbag sensor trigger(s) the side airbag inflators and/or the curtain shield airbag inflators. At this time a chemical reaction in the inflators quickly fills the airbags with non-toxic gas to help restrain the lateral motion of the occupants.

When the airbags inflate, they produce a fairly loud noise and release some smoke and residue along with non-toxic gas. This does not indicate a fire. This smoke may remain inside the vehicle for some time, and may cause some minor irritation to the eyes, skin or breathing. Be sure to wash off any residue as soon as possible to prevent any potential skin irritation with soap and water. If you can safely exit from the vehicle, you should do so immediately.

Deployment of the airbags happens in a fraction of a second, so the airbags must inflate with considerable force. While the system is designed to reduce serious injuries, it may also cause minor burns or abrasions and swelling.

Front seats as well as parts of the front and rear pillars, and roof side rail may be hot for several minutes, but the airbags themselves will not be hot. The airbags are designed to inflate only once.

CAUTION

SRS side airbags and curtain shield airbags inflate with considerable force. To reduce the possibility of death or serious injury when they inflate, the driver, front passenger and rear outside passengers must:

- **Wear their seat belts properly.**
- **Remain properly seated with their backs upright and against the seats at all times.**

OCCUPANT RESTRAINT SYSTEMS



- Do not allow anyone to lean against the door when the vehicle is in use, since the side airbag and curtain shield airbag could inflate with considerable speed and force. Otherwise, he/she may be killed or seriously injured. Special care should be taken especially when you have a small child in the vehicle.
- Sit up straight and well back in the seat, distributing your weight evenly in the seat. Do not apply excessive weight to the outer side of the seats with a side airbag and to the front pillar, rear pillar and roof side rail with a curtain shield airbag.



- Do not allow anyone to get his/her head close to the area where the side airbag and curtain shield airbag inflate, since these airbags could inflate with considerable speed and force. Otherwise, he/she may be killed or seriously injured. Special care should be taken especially when you have a small child in the vehicle.
- Do not allow anyone to kneel on the passenger seat, facing the passenger's side door, since the side airbag and curtain shield airbag could inflate with considerable speed and force. Otherwise, he/she may be killed or seriously injured. Special care should be taken especially when you have a small child in the vehicle.

OCCUPANT RESTRAINT SYSTEMS



- Do not allow anyone to get his/her head or hands out of windows, since the curtain shield airbags could inflate with considerable speed and force. Otherwise, he/she may be killed or seriously injured. Special care should be taken especially when you have a small child in the vehicle.



- Do not attach a cup holder or any other device or object on or around the door. When the side airbag inflates, the cup holder or any other device or object will be thrown with great force, or the side airbag may not activate correctly, resulting in death or serious injury. Likewise, the driver and front passenger should not hold objects in their arms or on their knees.

OCCUPANT RESTRAINT SYSTEMS



- Do not attach a microphone or any other device or object around the area where the curtain shield airbag activates such as on the windshield glass, side door glass, front and rear pillars, roof side rail and assist grips. When the curtain shield airbag inflates, the microphone or other device or object will be thrown away with great force or the curtain shield airbag may not activate correctly, resulting in death or serious injury.
- Do not hook a hanger, heavy or sharp pointed objects on the coat hook. If the curtain shield airbag inflates, those items will be thrown away with great force or the curtain shield airbag may not activate correctly, resulting in death or serious injury. When you hang clothes, hang them on the coat hook directly.

- Do not use seat accessories which cover the parts where the side airbags inflate. Such accessories may prevent the side airbags from activating correctly, causing death or serious injury.
- Do not modify or replace the seats or upholstery of the seats with side airbags. Such changes may prevent the side airbag system from activating correctly, disable the system or cause the side airbags to inflate accidentally, resulting in death or serious injury.
- Do not disassemble or repair the front and rear pillars and roof side rails containing the curtain shield airbags. Such changes may disable the system or cause the curtain shield airbags to inflate accidentally, resulting in death or serious injury.

Failure to follow these instructions can result in death or serious injury. Consult your Lexus dealer about any repair and modification.

OCCUPANT RESTRAINT SYSTEMS

NOTICE

Do not perform any of the following changes without consulting your Lexus dealer. Such changes can interfere with proper operation of the SRS side airbag and curtain shield airbag system in some cases.

- *Installation of electronic devices such as a mobile two-way radio, cassette tape player or compact disc player.*
- *Modification of the suspension system.*
- *Modification of the structure of the passenger compartment.*
- *Repairs made on or near the console or front seat.*



The indicator comes on when the ignition switch is turned to the "ON" position. It goes off after about 6 seconds. This means the SRS side airbags and curtain shield airbags are operating properly.

This warning light system monitors the airbag sensor assembly, front airbag sensors, side and curtain shield airbag sensor assemblies, curtain shield airbag sensor assemblies, driver's seat position sensor, driver's seat belt buckle switch, occupant detection sensor, front passenger's seat belt buckle switch, seat belt pretensioner assemblies, inflators, warning light, interconnecting wiring and power sources. (For details, see "Service reminder indicators and warning buzzers" on page 81.)

OCCUPANT RESTRAINT SYSTEMS

If any of the following conditions occurs, this indicates a malfunction of the airbags or seat belt pretensioners. Contact your Lexus dealer as soon as possible.

- When the ignition switch is turned to the "ON" position, the light does not come on or remains on.
- The light comes on while driving.

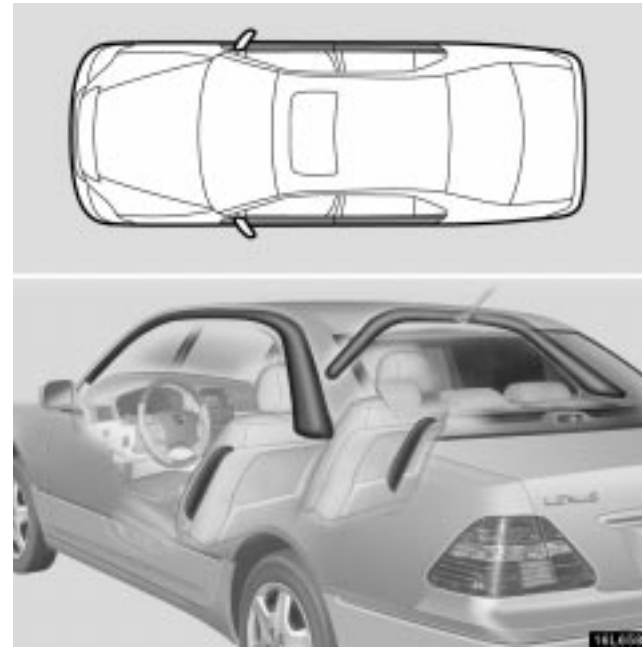

OCCUPANT RESTRAINT SYSTEMS

In the following cases, contact your Lexus dealer as soon as possible:

- Any of the SRS side airbags and curtain shield airbags have been inflated.
- The portion of the doors (shaded in the illustration) was involved in an accident that was not severe enough to cause the SRS side airbags and curtain shield airbags to inflate.
- The surface of the seats with the side airbag (shaded in the illustration) is scratched, cracked, or otherwise damaged.
- The portion of the front pillars, rear pillars or roof side rail garnishes (padding) containing the curtain shield airbags inside (shaded in the illustration) is scratched, cracked, or otherwise damaged.

NOTICE

Do not disconnect the battery cables before contacting your Lexus dealer.

CHILD RESTRAINT

Child restraint precautions

Lexus strongly urges the use of appropriate child restraint systems for children.

The laws of all 50 states in the U.S.A. and Canada now require the use of a child restraint system.

Your vehicle conforms to SAE J1819.

If a child is too large for a child restraint system, the child should sit in the rear seat and must be restrained using the vehicle's seat belt. See "Seat belts" on page 165 for details.

CAUTION

- For effective protection in automobile accidents and sudden stops, a child must be properly restrained, using a seat belt or child restraint system depending on age and size of the child. Holding a child in your arms is not a substitute for a child restraint system. In an accident, the child can be crushed against the windshield, or between you and the vehicle's interior.
- Lexus strongly urges use of a proper child restraint system which conforms to the size of the child, installed on the rear seat. According to accident statistics, the child is safer when properly restrained in the rear seat than in the front seat.

OCCUPANT RESTRAINT SYSTEMS

- Never install a rear-facing child restraint system on the front passenger seat. In the event of an accident, the force of the rapid inflation of the front passenger airbag can cause death or serious injury to the child if the rear-facing child restraint system is installed on the front passenger seat.
- A forward-facing child restraint system should be allowed to be installed on the front passenger seat only when it is unavoidable. Always move the seat as far back as possible, because the front passenger airbag could inflate with considerable speed and force. Otherwise, the child may be killed or seriously injured.
- Do not allow the child to lean his/her head or any part of his/her body against the door or the area of the seat, front or rear pillar or roof side rail from which the side airbags or curtain shield airbags deploy even if the child is seated in the child restraint system. It is dangerous if the side airbags and curtain shield airbags inflate, and the impact could cause death or serious injury to the child.
- Do not use the seat belt extender when installing a child restraint system on the front or rear passenger seat. If installing a child restraint system with the seat belt extender connected to the seat belt, the seat belt will not securely hold the child restraint system, which could cause death or serious injury to the child or other passengers in the event of collision.

- Make sure you have complied with all installation instructions provided by the child restraint manufacturer and that the system is properly secured. If it is not secured properly, it may cause death or serious injury to the child in the event of a sudden stop or accident.

OCCUPANT RESTRAINT SYSTEMS

Child restraint system

A child restraint system for a small child or baby must itself be properly restrained on the seat with the lap portion of the lap/shoulder belt. You must carefully consult the manufacturer's instructions which accompany the child restraint system.

To provide proper restraint, use a child restraint system following the manufacturer's instructions about the appropriate age and size of the child for the child restraint system.

Install the child restraint system correctly following the instructions provided by its manufacturer. General directions are also provided under the following illustrations.

The child restraint system should be installed on the rear seat. According to accident statistics, the child is safer when properly restrained in the rear seat than in the front seat.

When not using the child restraint system, keep it secured with the seat belt or place it in the trunk or somewhere other than the passenger compartment. This will prevent it from injuring passengers in the event of a sudden stop or accident.

Types of child restraint system

Child restraint systems are classified into the following 3 types depending on the child's age and size.

- (A) Infant seat
- (B) Convertible seat
- (C) Booster seat

Install the child restraint system following the instructions provided by its manufacturer.

Your vehicle has anchor brackets for securing the top strap of a child restraint system.

For instructions about how to use the anchor bracket, see "Using a top strap" on page 212.

The child restraint lower anchorages approved for your vehicle may also be used. See "Installation with child restraint lower anchorages" on page 214.

OCCUPANT RESTRAINT SYSTEMS

(A) Infant seat

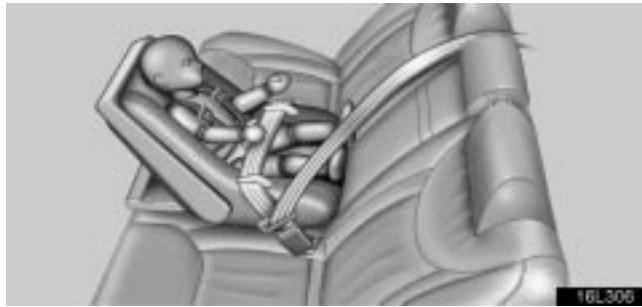

(C) Booster seat



(B) Convertible seat



OCCUPANT RESTRAINT SYSTEMS

INSTALLATION WITH 3-POINT TYPE SEAT BELT

(A) Infant seat installation

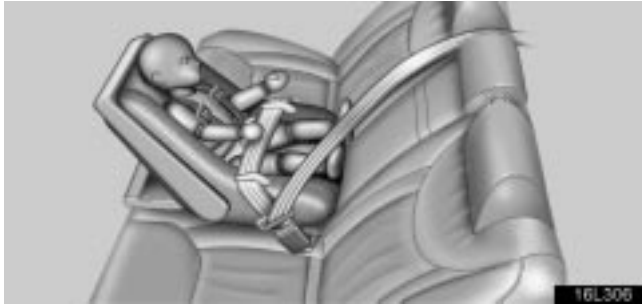

An infant seat must be used in rear-facing position only.

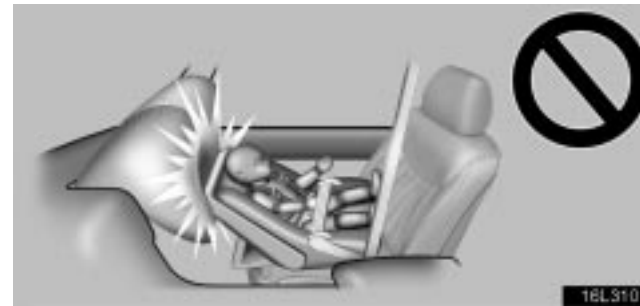

CAUTION

- Never install a rear-facing child restraint system on the front passenger seat. In the event of an accident, the force of the rapid inflation of the front passenger airbag can cause death or serious injury to the child if the rear-facing child restraint system is installed on the front passenger seat.

OCCUPANT RESTRAINT SYSTEMS



- If the driver's seat position does not allow sufficient space for safe installation, install the child restraint system on the rear right seat.



- 1 Fix both seats at the same position.
- 2 Fix both seatbacks at the same angle.

CAUTION

When installing a child restraint system in the rear center position, adjust both seat cushions to the same position and align both seatbacks at the same angle. Otherwise, the child restraint system cannot be securely restrained and this may cause death or serious injuries in a collision.

OCCUPANT RESTRAINT SYSTEMS

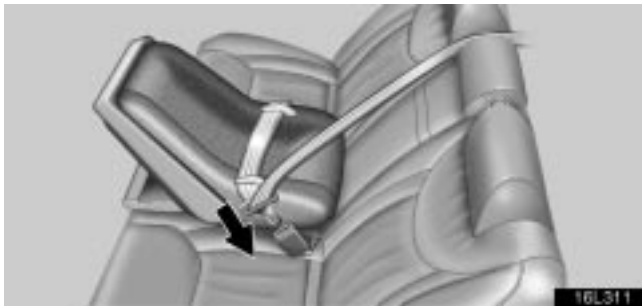

1. Run the lap and shoulder belt through or around the infant seat following the instructions provided by its manufacturer and insert the tab into the buckle taking care not to twist the belt. Keep the lap portion of the belt tight.

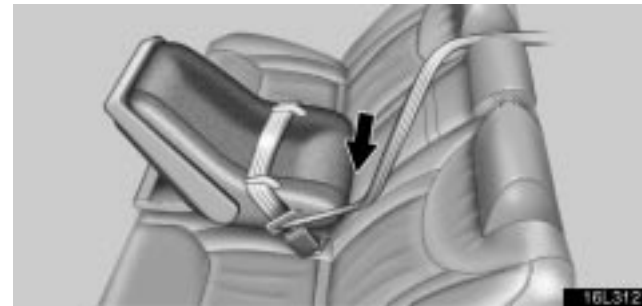

2. Fully extend the shoulder belt to put it in the lock mode. When the belt is then retracted even slightly, it cannot be extended.

To hold the infant seat securely, make sure the belt is in the lock mode before letting the belt retract.

CAUTION

- After inserting the tab, make sure the tab and buckle are locked and that the lap and shoulder portions of the belt are not twisted.
- Do not insert coins, clips, etc. in the buckle as this may prevent your child from properly latching the tab and buckle.
- If the seat belt does not function normally, it cannot protect your child from death or serious injury. Contact your Lexus dealer immediately. Do not install the child restraint system on the seat until the seat belt is fixed.

OCCUPANT RESTRAINT SYSTEMS

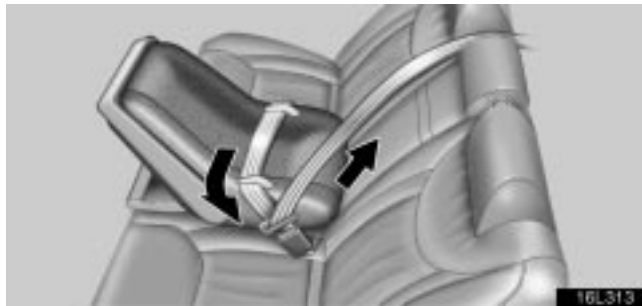

3. While pressing the infant seat firmly against the seat cushion and seatback, let the shoulder belt retract as far as it will go to hold the infant seat securely.



CAUTION

Push and pull the child restraint system in different directions to be sure it is secure. Follow all the installation instructions provided by its manufacturer.

OCCUPANT RESTRAINT SYSTEMS



4. To remove the infant seat, press the buckle release button and allow the belt to retract completely. The belt will move freely again and be ready to work for an adult or older child passenger.

(B) Convertible seat installation



A convertible seat must be used in forward-facing or rear-facing position depending on the age and size of the child. When installing, follow the manufacturer's instructions about the appropriate age and size of the child as well as directions for installing the child restraint system.

OCCUPANT RESTRAINT SYSTEMS

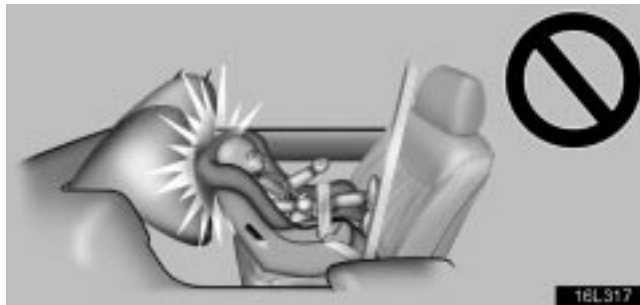

CAUTION

- Never install a rear-facing child restraint system on the front passenger seat. In the event of an accident, the force of the rapid inflation of the front passenger airbag can cause death or serious injury to the child if the rear-facing child restraint system is installed on the front passenger seat.



► *Move seat fully back*

- A forward-facing child restraint system should be allowed to be installed on the front passenger seat only when it is unavoidable. Always move the seat as far back as possible, because the front passenger airbag could inflate with considerable speed and force. Otherwise, the child may be killed or seriously injured.
- Do not allow the child to lean his/her head or any part of his/her body against the door or the area of the seat, front or rear pillar, or roof side rail from which the side airbags or curtain shield airbags deploy even if the child is seated in the child restraint system. It is dangerous if the side airbag and curtain shield airbag inflate, and the impact could cause death or serious injury to the child.

OCCUPANT RESTRAINT SYSTEMS



- If the driver's seat position does not allow sufficient space for safe installation, install the child restraint system on the rear right seat.

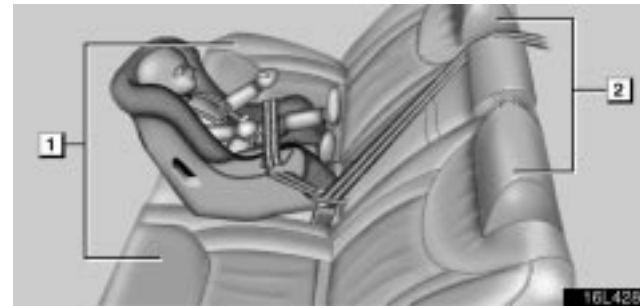

- 1 Fix both seats at the same position.
- 2 Fix both seatbacks at the same angle.

CAUTION

When installing a child restraint system in the rear center position, adjust both seat cushions to the same position and align both seatbacks at the same angle. Otherwise, the child restraint system cannot be securely restrained and this may cause death or serious injuries in a collision.

OCCUPANT RESTRAINT SYSTEMS



1. Run the lap and shoulder belt through or around the convertible seat following the instructions provided by its manufacturer and insert the tab into the buckle taking care not to twist the belt. Keep the lap portion of the belt tight.



2. Fully extend the shoulder belt to put it in the lock mode. When the belt is then retracted even slightly, it cannot be extended.

To hold the convertible seat securely, make sure the belt is in the lock mode before letting the belt retract.

CAUTION

- After inserting the tab, make sure the tab and buckle are locked and that the lap and shoulder portions of the belt are not twisted.
- Do not insert coins, clips, etc. in the buckle as this may prevent your child from properly latching the tab and buckle.
- If the seat belt does not function normally, it cannot protect your child from death or serious injury. Contact your Lexus dealer immediately. Do not install the child restraint system on the seat until the seat belt is fixed.

OCCUPANT RESTRAINT SYSTEMS



3. While pressing the convertible seat firmly against the seat cushion and seatback, let the shoulder belt retract as far as it will go to hold the convertible seat securely.



⚠ CAUTION

Push and pull the child restraint system in different directions to be sure it is secure. Follow all the installation instructions provided by its manufacturer.

OCCUPANT RESTRAINT SYSTEMS

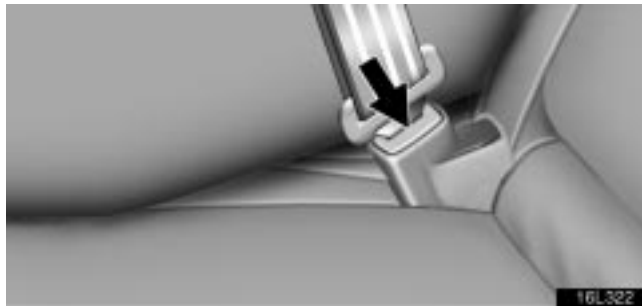

4. To remove the convertible seat, press the buckle release button and allow the belt to retract completely. The belt will move freely again and be ready to work for an adult or older child passenger.

(C) Booster seat installation



A booster seat must be used in forward-facing position only.

OCCUPANT RESTRAINT SYSTEMS



► **Move seat fully back**

CAUTION

- A forward-facing child restraint system should be allowed to be installed on the front passenger seat only when it is unavoidable. Always move the seat as far back as possible, because the front passenger airbag could inflate with considerable speed and force. Otherwise, the child may be killed or seriously injured.
- Do not allow the child to lean his/her head or any part of his/her body against the door or the area of the seat, front or rear pillar or roof side rail from which the side airbags or curtain shield airbags deploy even if the child is seated in a child restraint system. It is dangerous if the side airbag and curtain shield airbag inflate, and the impact could cause death or serious injury to the child.



1. Sit the child on a booster seat. Run the lap and shoulder belt through or around the booster seat and across the child following the instructions provided by its manufacturer and insert the tab into the buckle taking care not to twist the belt.

Make sure the shoulder belt is correctly across the child's shoulder and that the lap belt is positioned as low as possible on the child's hips. See "Seat belts" on page 165 for details.

CAUTION

- Always make sure the shoulder belt is positioned across the center of child's shoulder. The belt should be kept away from child's neck, but not falling off child's shoulder. Otherwise, the child may be killed or seriously injured in case of sudden braking or a collision.

OCCUPANT RESTRAINT SYSTEMS

- Both high-positioned lap belts and loose-fitting belts could cause death or serious injuries due to sliding under the lap belt during a collision or other unintended event. Keep the lap belt positioned as low on a child's hips as possible.
- For child's safety, do not place the shoulder belt under child's arm.
- After inserting the tab, make sure the tab and buckle are locked and that the lap and shoulder portions of the belt are not twisted.
- Do not insert coins, clips, etc. in the buckle as this may prevent your child from properly latching the tab and buckle.
- If the seat belt does not function normally, it cannot protect your child from death or serious injury. Contact your Lexus dealer immediately. Do not install the child restraint system on the seat until the seat belt is fixed.



2. To remove the child restraint system, press the buckle release button and allow the belt to retract.

OCCUPANT RESTRAINT SYSTEMS

Using a top strap



Follow the procedure below for a child restraint system that requires the use of a top strap.

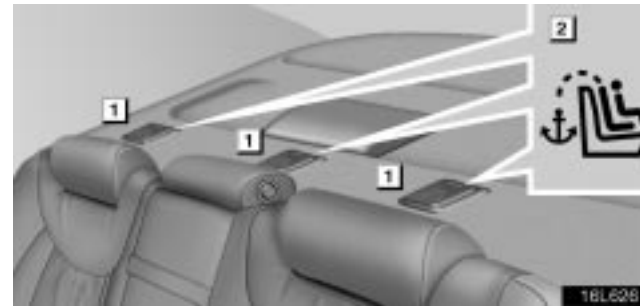

► **1** Anchor bracket **2** Symbol

Use the anchor bracket on the package tray behind the rear seat to attach the top strap.

Anchor brackets are installed for each rear seating position.

This symbol indicates the locations of the anchor bracket.

OCCUPANT RESTRAINT SYSTEMS

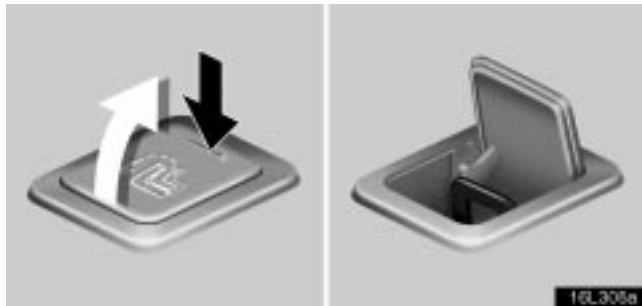

TO USE THE ANCHOR BRACKET

1. Push the lid of the anchor bracket to open it.



2. Fix the child restraint system with the seat belt.
3. Latch the hook onto the anchor bracket and tighten the top strap.

When using a top strap in the outside rear seat, the head restraint should be lowered down fully and moved rearward. For the center rear seat, the head restraint should be in the original position. Then make sure to pass the top strap over the head restraint.

For instructions to install the child restraint system, see "Types of child restraint system" on page 198.

When the child restraint is not in use, make sure the head restraint is mounted.

OCCUPANT RESTRAINT SYSTEMS

CAUTION

- Do not slide the seat or adjust the head restraint after securing the child restraint system.
- Make sure the top strap is securely latched, and check that the child restraint system is secure by pushing and pulling it in different directions.

Follow all the installation instructions provided by its manufacturer.

Installation with child restraint lower anchorages



The lower anchorages for the child restraint system interfaced with the FMVSS225 or CMVSS210.2 specification are installed in the rear seat.

The anchorages are installed in the clearance between the seat cushion and seatback of both outside rear seats.

Child restraint system interfaced with the FMVSS225 or CMVSS210.2 specification can be fixed with these anchorages. In this case, it is not necessary to fix the child restraint system with a seat belt on the vehicle.

OCCUPANT RESTRAINT SYSTEMS

CHILD RESTRAINT SYSTEM INSTALLATION

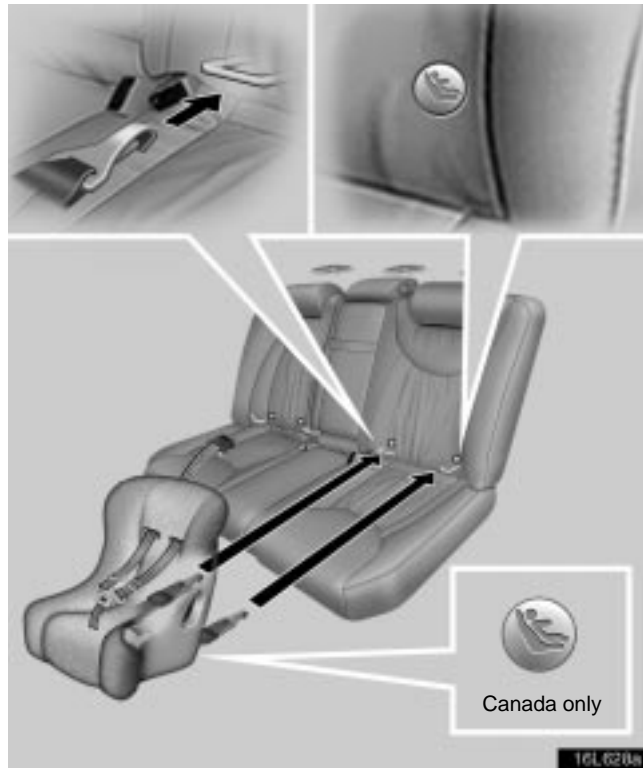

► Type A

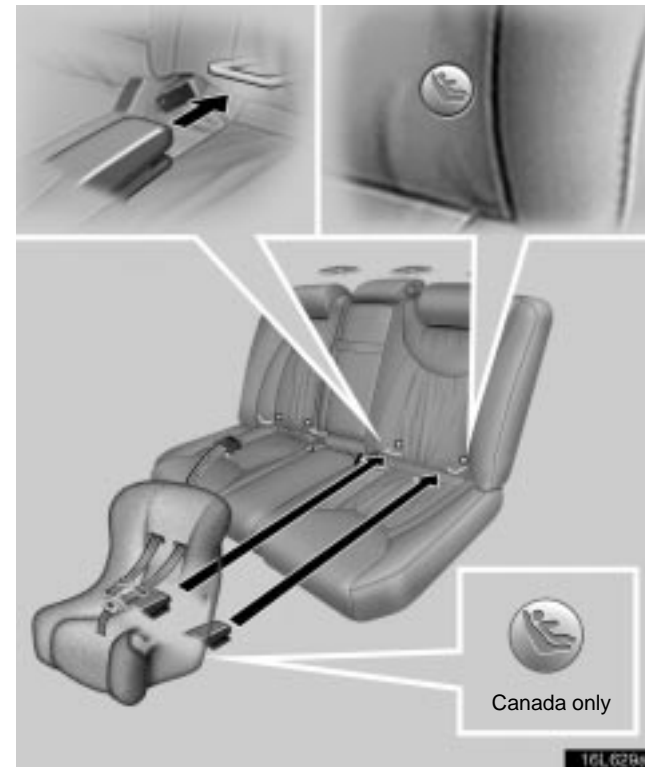

► Type B

OCCUPANT RESTRAINT SYSTEMS

For owners in Canada

The symbol on a child restraint system indicates the presence of a lower connector system.

Type A:

1. **Widen the clearance between the seat cushion and seatback a little and confirm the position of the lower anchorages below the symbol in the seatback.**
2. **Latch the hooks of lower straps onto the anchorages and tighten the lower straps.**

Type B:

1. **Widen the clearance between the seat cushion and seatback a little and confirm the position of the lower anchorages below the symbol in the seatback.**
2. **Latch the buckles onto the anchorages.**

If your child restraint system has a top strap, it should be anchored. (For the installation of the top strap, see "Using a top strap" on page 212.)

For installation details, refer to the instruction manual equipped with each product.

CAUTION

- **When using the lower anchorages for the child restraint system, be sure that there are no irregular objects around the anchorages or that the seat belt is not caught.**
- **Push and pull the child restraint system in different directions to be sure it is secure. Follow all the installation instructions provided by its manufacturer.**
- **When using the lower anchorages for a child restraint system, ensure that the seat is moved to the rear-most position, with the seatback close to the child restraint system.**
- **After securing the child restraint system, never slide the seat.**

DRIVING POSITION MEMORY SYSTEM

A microcomputer will memorize the position of the driver's seat, the height of the head restraint of the driver's seat, the seat cushion length of the driver's seat, the height of the shoulder belt anchor of the driver's seat belt, and the positions of the tilt and telescopic steering, and outside rear view mirrors. Three different driving position profiles can be entered into the computer's memory.

Recording a driving position in the computer's memory can only be done when the ignition switch is in the "ON" position and the selector lever is in the "N" or "P" position.

Setting the driving position



1. Adjust the driver's seat, driver's head restraint height and seat cushion length, driver's shoulder belt anchor, tilt and telescopic steering and outside rear view mirrors to the desired position.

2. While pushing the "SET" button, push button "1", "2" or "3" until the signal beeps.

The beep sound means that the positions are recorded in the computer's memory.

By repeating these two steps and pressing the remaining button, the driving position for another driver can be recorded.

To set a new memorized position, select the desired position and perform step 2. The previous memory will be erased and the new position will be set.

To make only slight changes to an already memorized position, the easiest way is to first activate the memorized position, then make the desired changes and perform step 2 above.

OCCUPANT RESTRAINT SYSTEMS

Recalling the memorized position



When you push button “1”, “2” or “3”, the driving position will be automatically adjusted to the position recorded for that button.

Conditions for memorized position activation

- Ignition switch “ON” and selector lever in “N” or “P” position with the vehicle stopped.
All parts of the memorized positions can be activated.
- Ignition switch off and within 30 seconds of opening driver’s door.

The memorized position can be activated, except for the tilt and telescopic steering.

If any driving position memory switch is pushed while one of the memorized driving position profiles is being activated, the operation will stop.

To activate the system, push the desired button (“1”, “2” or “3”) again.

The driving position memory control system cannot be operated while the vehicle is moving.

CAUTION

- Do not start the vehicle while the adjustments are being made.
- Take care not to select the wrong button, or the seat could strike the rear passenger or hit your body against the steering wheel. If this happens, you can stop the movement by pressing another driving position memory switch.

MEMORY CALL SYSTEM USING A SMART KEY

This system allows you to adjust the driver's seat, the driver's head restraint height, driver's seat cushion length, the height of the shoulder belt anchor of the driver's seat belt and outside rear view mirrors to the memorized position when you open the driver's door after unlocking it with a smart key. And when you push the ignition switch, the tilt and telescopic steering is adjusted.

To activate this system, the ID of the smart key needs to be registered in the memory button.

Registering the smart key ID code

Before the registration of the ID of the smart key, the driving position must be memorized in the memory button.

When registering, the driver's door must be closed with the ignition switch in the "OFF" position.

1. Keep the smart key in possession, select a button in which you want to record the ID of the key from buttons "1", "2" and "3" and push it.
2. Push the "LOCK" or "UNLOCK" button on the smart key for about one second with button "1", "2" or "3" held down.

When the registration is completed, one beep sounds. If the key has already been registered, the previous memory will be erased. If the same driving position profile for the same key is registered in another button, that memory will also be erased.



CAUTION

Do not push the "LOCK" button any longer than 2 or 3 seconds. Pushing the button longer activates an alarm. For details, see page 40.

Erasing the previous registration memory

The driver's door must be closed with the ignition switch in the "OFF" position.

1. Keep the smart key in which you want to cancel the registration in possession and push the "SET" button.
2. Push the "LOCK" or "UNLOCK" button on the smart key for about one second with the "SET" button held down.

When the previous key ID memory is erased, two beeps sound.

OCCUPANT RESTRAINT SYSTEMS

MEMORY CALL SYSTEM USING A WIRELESS REMOTE CONTROL KEY

This system allows you to adjust the driver's seat, the driver's head restraint height, driver's seat cushion length, the height of the shoulder belt anchor of the driver's seat belt and outside rear view mirrors to the memorized position when you open the driver's door after unlocking it with a wireless remote control key. And when you insert the key into the ignition switch, the tilt and telescopic steering is adjusted.

To activate this system, the ID of the wireless remote control key needs to be registered in the memory button.

Registering the wireless remote control key ID code

Before the registration of the ID of the wireless remote control key, the driving position must be memorized in the memory button.

When registering, the driver's door must be closed with the ignition switch in the "OFF" position.

1. **Keep the wireless remote control key in possession, select a button in which you want to record the ID of the key from buttons "1", "2" and "3" and push it.**
2. **Push the "LOCK" or "UNLOCK" button on the wireless remote control key for about one second with button "1", "2" or "3" held down.**

When the registration is completed, one beep sounds. If the key has already been registered, the previous memory will be erased. If the same driving position profile for the same key is registered in another button, that memory will also be erased.

CAUTION

Do not push the "LOCK" button any longer than 2 or 3 seconds. Pushing the button longer activates an alarm. For details, see page 40.

Erasing the previous registration memory

The driver's door must be closed with the ignition switch in the "OFF" position.

1. **Keep the wireless remote control key in which you want to cancel the registration in possession and push the "SET" button.**
2. **Push the "LOCK" or "UNLOCK" button on the wireless remote control key for about one second with the "SET" button held down.**

When the previous key ID memory is erased, two beeps sound.

REAR SEAT POSITION MEMORY SYSTEM

A microcomputer will memorize the position of the rear seats and the height of the rear head restraints.

Recording the rear seat position in the computer's memory can only be done when the ignition switch is in the "ON" position.

Setting the rear seat position



1. Adjust the rear seat position and the height of the head restraint of the rear seat to the desired position.

2. Keep pushing the "SET" button until a beep sounds.

The beep sound means that the position has been memorized. The memory will be erased when the battery is removed for inspection or service.

Recalling the memorized position



Keep pressing the "M" button until a beep sounds; the rear seat and rear head restraint positions will be automatically adjusted to the memorized position.

If the "M" switch is pushed while the memorized position profile is being activated, the operation will stop.

Do not place anything under the rear seat as this might interfere with seat movement.

OCCUPANT RESTRAINT SYSTEMS

Door opening linked seat sliding function

The rear seat automatically moves backward when the rear door is opened if the seat is adjusted to a forward position.

The ignition switch must be in the "ON" position.

This function is actuated when the selector lever is set in the "P" position or if the vehicle is stopped with the brake pedal depressed.

While the seat is being moved by this function, the operation will not stop even if the door is closed midway.



To cancel this function, push the "C" button.

The indicator light comes on.

To reactivate the function once again, push the "C" button.

The indicator light goes off.

;

SECTION 1 - 7

INSTRUMENTS AND CONTROLS

Steering wheel and mirrors

Tilt and telescopic steering wheel	225
Outside rear view mirrors	227
Inside rear view mirror	231
Vanity mirrors	232

TILT AND TELESCOPIC STEERING WHEEL

Adjustment of steering wheel tilt

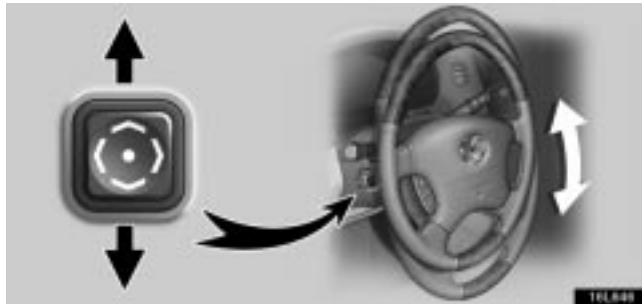

To adjust the tilt of the steering wheel, push the control switch upward or downward to set it to the desired position.

! CAUTION

Do not adjust the steering wheel while the vehicle is moving. Doing so may cause the driver to mishandle the vehicle and an accident may occur resulting in death or serious injuries.

Adjustment of telescopic steering column

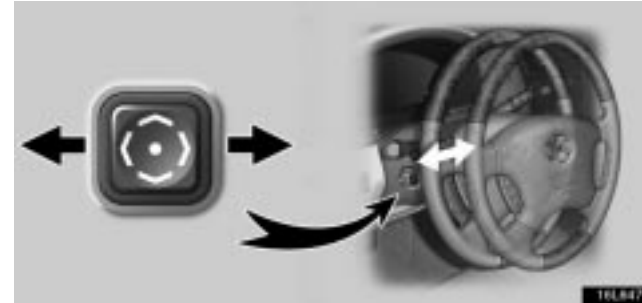

To adjust the steering column length, push the control switch forward or backward to set the steering wheel to the desired position.

! CAUTION

Do not adjust the steering column while the vehicle is moving. Doing so may cause the driver to mishandle the vehicle and an accident may occur resulting in death or serious injuries.

STEERING WHEEL AND MIRRORS

Auto tilt away*

In case of the smart key system:

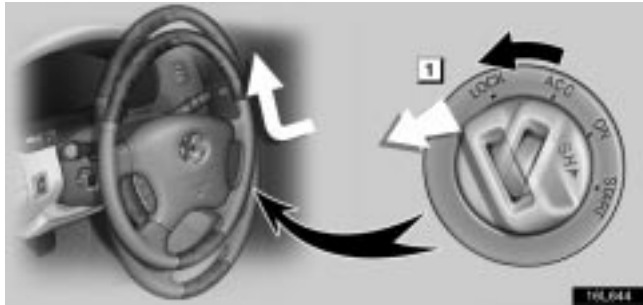

When the smart key system is used, turning the ignition switch **1** to the “LOCK” position moves the steering column forward away from the driver and also tilts it up for easy exit and entry.

When you push in the ignition switch, the steering column returns to the previously set position.

NOTE:

* This feature can be deactivated.
Ask your Lexus dealer for details.

When the key is inserted into the ignition:

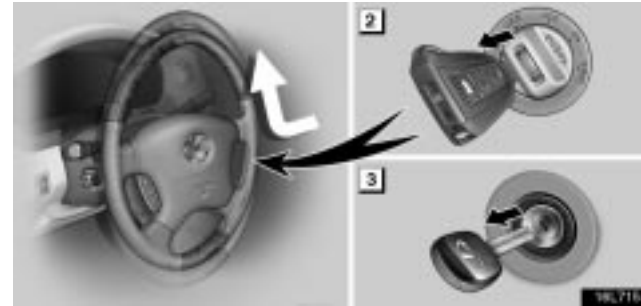

When you remove the smart key **2** or ignition key **3**, the steering column moves forward away from the driver and also tilts up for easy exit and entry.

When you insert the key in the ignition switch, the steering column returns to the previously set position.

NOTE:

* This feature can be deactivated.
Ask your Lexus dealer for details.

OUTSIDE REAR VIEW MIRRORS



Adjust the mirror so that you can just see the side of your vehicle in the mirror.

Be careful when judging the size or distance of any object seen in the outside rear view mirror on the passenger's side because it is a convex mirror. Any object seen in a convex mirror will look smaller and farther away than if seen in a normal flat mirror.

When the inside rear view mirror darkens in "AUTO" mode, the outside rear view mirrors also darken to reduce the reflection of the headlights of the following vehicle. For details, see "Inside rear view mirror" on page 231.

When you push the rear window and outside rear view mirror defogger switch or operate the wipers, the heater panels in the outside rear view mirrors will quickly clear the mirror surface. (See "Windshield wiper and washer switch" on page 58 and "Rear window and outside rear view mirror defogger switch" on page 63.)



CAUTION

- **Do not adjust the mirror while the vehicle is moving. Doing so may cause the driver to mishandle the vehicle and an accident may occur resulting in death or serious injuries.**
- **Since the mirror surfaces can get hot, do not touch them when the rear window and outside rear view mirror defogger switch is on.**

STEERING WHEEL AND MIRRORS

Power rear view mirror control



► **1** Master switch **2** Control switch

To adjust the power rear view mirror, first place the master switch at “L” (left) or “R” (right), and push the control switch on the desired side.

The power rear view mirrors can be adjusted when the ignition switch is in the “ACC” or “ON” position.

When you are backing up, you can adjust the mirrors down quickly by the following operations with the ignition ON.

- Put the selector lever in the “R” position.
- Place the master switch at “L” (left) or “R” (right).

The mirrors return to the previous position by any of the following operations.

- Put the selector lever in a position other than “R”.
- Place the master switch in the neutral position.
- Turn the ignition switch to the “ACC” position.

NOTICE

If ice should jam the mirror, do not operate the control or scrape the mirror face. Use a spray de-icer to free the mirror.

Folding and extending automatic rear view mirrors

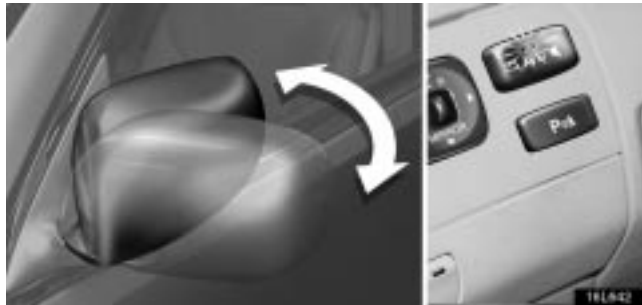

With the rear view mirror folding switch in the “AUTO” position:

- When you turn the ignition switch to “ACC” or “ON” position, the folded rear view mirrors are automatically extended.
- When you turn the ignition switch to “LOCK” position, the rear view mirrors are automatically folded.

The rear view mirrors can be folded or extended manually.

CAUTION

- To avoid personal injury and mirror malfunction, do not touch the mirror while it is moving.
- Do not drive with the mirrors folded backward. Both the driver and passenger side rear view mirrors must be extended and properly adjusted before driving.

Folding rear view mirrors



To fold the mirrors, push the switch on the right side. To extend the rear view mirrors, push the switch on the left side.

The rear view mirrors can be folded backward for parking in compact areas.

CAUTION

- To avoid personal injury and any mirror malfunction, do not touch the mirror while it is moving.
- Do not drive with the mirrors folded backward. Both the driver and passenger side rear view mirrors must be extended and properly adjusted before driving.

STEERING WHEEL AND MIRRORS

Outer foot lights



The outer foot lights illuminate the ground near the doors for about 15 seconds to ensure safe footing for the driver and passengers who are about to get in the vehicle.*

The outer foot lights come on when:

- you are getting closer to the vehicle carrying a smart key and you enter the effective range of the smart key system (about 1 m (3 ft) from each outside door handle),
- the doors are unlocked with the wireless remote control function key, or
- the doors are unlocked with the power door lock switch on the driver's side.

The outer foot lights go off 15 seconds after the lights come on or when:

- the lock switch on the outside door handle is pushed,
- the doors are locked with the wireless remote control function key,
- the doors are locked by inserting a key into the door keyhole,
- the doors are locked with the power door lock switch on the driver's side, or
- the selector lever is moved out of "P" position with the ignition on.

NOTE:

** The outer foot lights illuminating time can be changed. Ask your Lexus dealer for details.*

INSIDE REAR VIEW MIRROR

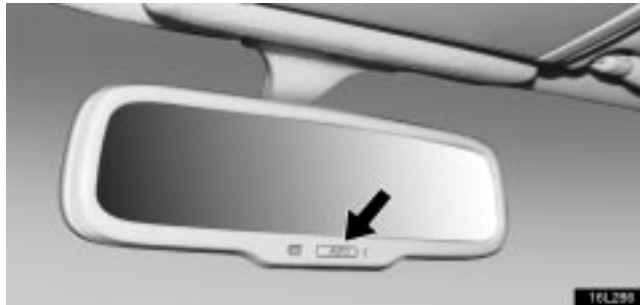

Adjust the mirror so that you can just see the rear of your vehicle in the mirror.

Pushing the switch changes the mode between “AUTO” and “DAY”.

The indicator comes on when the “AUTO” mode is selected.

“DAY” mode: The mirror surface is normal.

“AUTO” mode: If the mirror detects light from the headlights of the vehicle behind you, the mirror surface darkens slightly to reduce the reflected light.

When the inside rear view mirror surface changes, the outside rear view mirror surfaces will also become darker.

When the ignition switch is turned on, the inside rear view mirror always turns on in the “AUTO” mode.

When the outside air temperature is low, it may take a little longer for the mirror to darken in response to the detection of headlights.



CAUTION

Do not adjust the mirror while the vehicle is moving. Doing so may cause the driver to mishandle the vehicle and an accident may occur resulting in death or serious injuries.

STEERING WHEEL AND MIRRORS

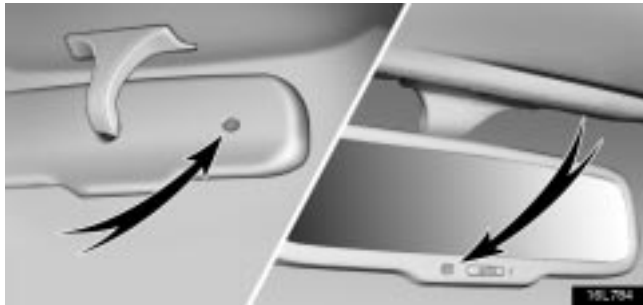

To ensure correct functioning of anti-glare mirror sensors located on both sides of the mirror, do not touch or cover the sensors with your finger or a piece of cloth, etc.

VANITY MIRRORS

Front



To use the front vanity mirrors, swing the sun visor down and open the cover.

The vanity light comes on when you open the cover. However if the sun visor is not hooked securely, the light may not come on.

Rear



To use the rear vanity mirrors, open the cover.

The vanity light comes on when you open the cover.

NOTICE

- *Keep the rear vanity mirrors closed when not in use. Otherwise you may hit your head on the mirror when you get in or out of the vehicle.*
- *To prevent the battery from being discharged, do not leave the cover open for a long time while the engine is stopped.*

SECTION 2-1

AIR CONDITIONING AND AUDIO

Air conditioning

Automatic air conditioning controls (Vehicles with rear air conditioning)	235
Automatic air conditioning controls (Vehicles without rear air conditioning)	237
Rear air conditioning controls	251

*For vehicles equipped with Navigation System,
please refer to the separate "Navigation System
Owner's Manual".*

AUTOMATIC AIR CONDITIONING CONTROLS (Vehicles with Rear Air Conditioning)

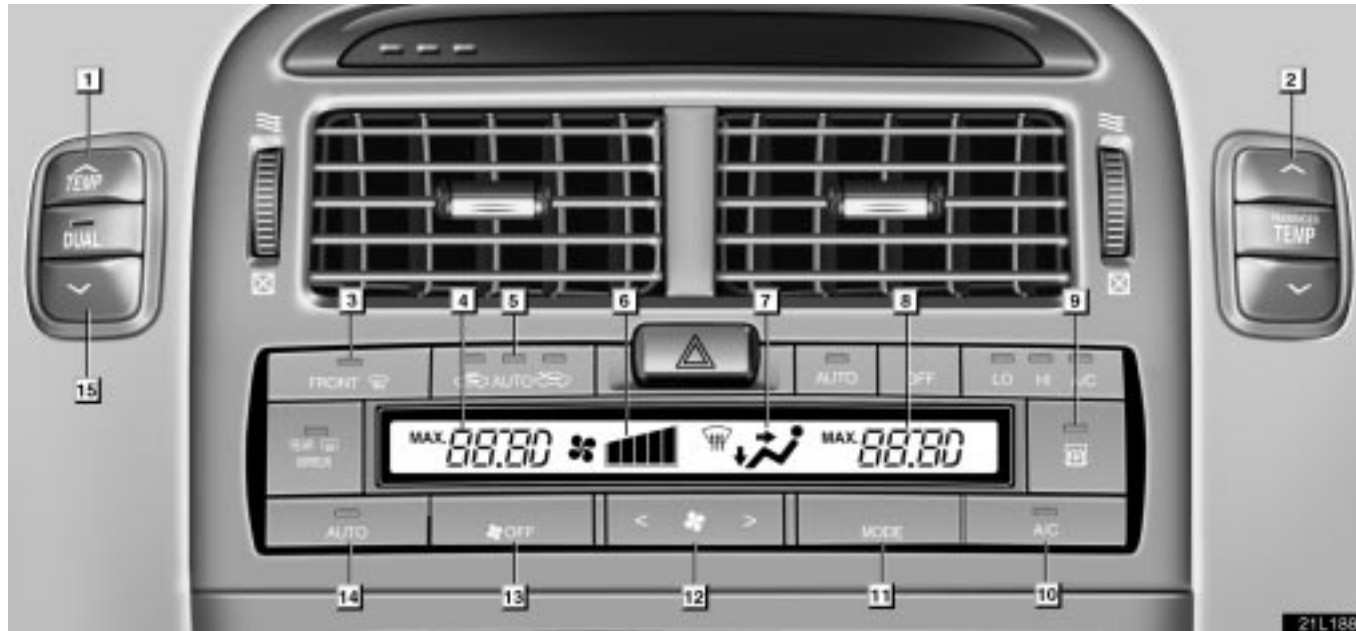

► For rear air conditioning operation, see “Rear air conditioning controls” on page 251

AIR CONDITIONING

The automatic air conditioning automatically maintains the set temperature.

This air conditioning features automatic fan speed and air flow control which automatically selects the most suitable fan speed and air flow to control the temperature.

The ignition switch must be in the "ON" position.

NOTICE

To prevent the battery from being discharged, do not leave the air conditioning on longer than necessary when the engine is not running.

- 1 *Temperature selector
(with the "DUAL" button on; for driver and rear passengers)
(with the "DUAL" button off; for driver and all passengers)*
- 2 *Passenger side temperature control button*
- 3 *Front windshield button*
- 4 *Driver side temperature display
(in degrees Fahrenheit or Centigrade)*
- 5 *Air intake control button*
- 6 *Fan speed display*
- 7 *Air flow display*
- 8 *Passenger side temperature display
(in degrees Fahrenheit or Centigrade)*
- 9 *Center vent vane swing button*
- 10 *Air conditioning on-off button*
- 11 *Air flow control button*
- 12 *Fan speed control button*
- 13 *OFF button*
- 14 *Automatic control button*
- 15 *Separate/dual control button*

AUTOMATIC AIR CONDITIONING CONTROLS (Vehicles without Rear Air Conditioning)

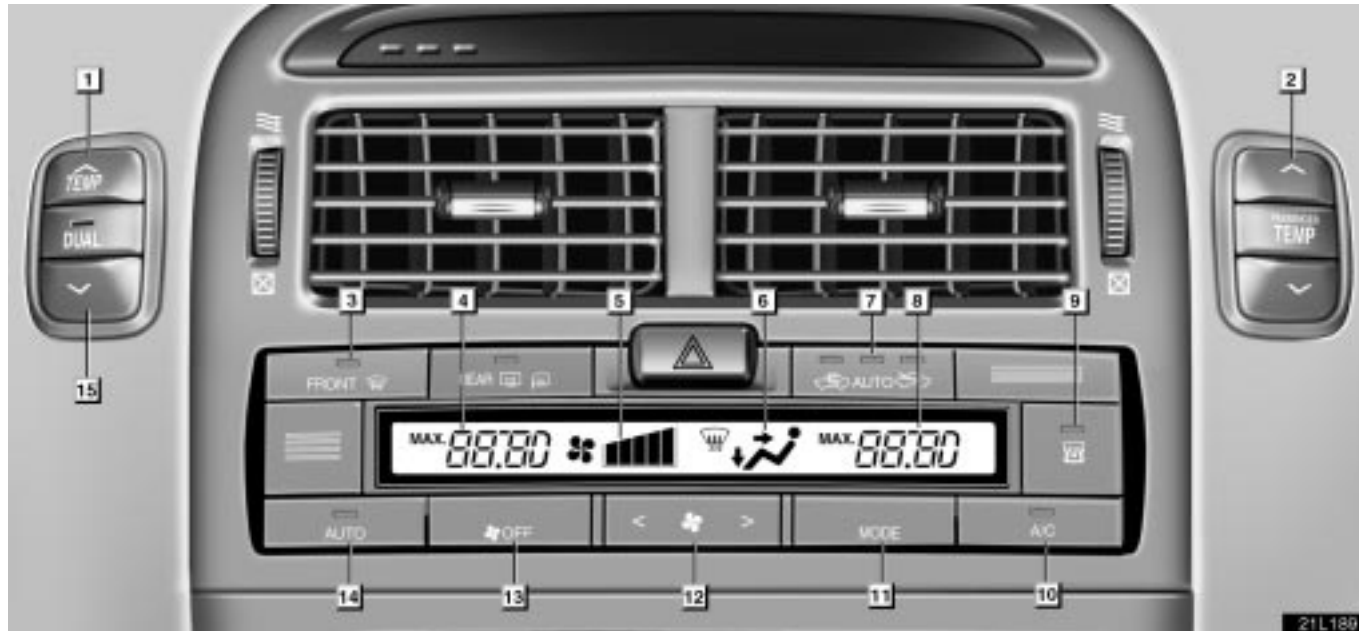

AIR CONDITIONING

The automatic air conditioning automatically maintains the set temperature.

This air conditioning features automatic fan speed and air flow control which automatically selects the most suitable fan speed and air flow to control the temperature.

The ignition switch must be in the "ON" position.

NOTICE

To prevent the battery from being discharged, do not leave the air conditioning on longer than necessary when the engine is not running.

- 1 *Temperature selector
(with the "DUAL" button on; for driver and rear passengers)
(with the "DUAL" button off; for driver and all passengers)*
- 2 *Passenger side temperature control button*
- 3 *Front windshield button*
- 4 *Driver side temperature display
(in degrees Fahrenheit or Centigrade)*
- 5 *Fan speed display*
- 6 *Air flow display*
- 7 *Air intake control button*
- 8 *Passenger side temperature display
(in degrees Fahrenheit or Centigrade)*
- 9 *Center vent vane swing button*
- 10 *Air conditioning on-off button*
- 11 *Air flow control button*
- 12 *Fan speed control button*
- 13 *OFF button*
- 14 *Automatic control button*
- 15 *Separate/dual control button*

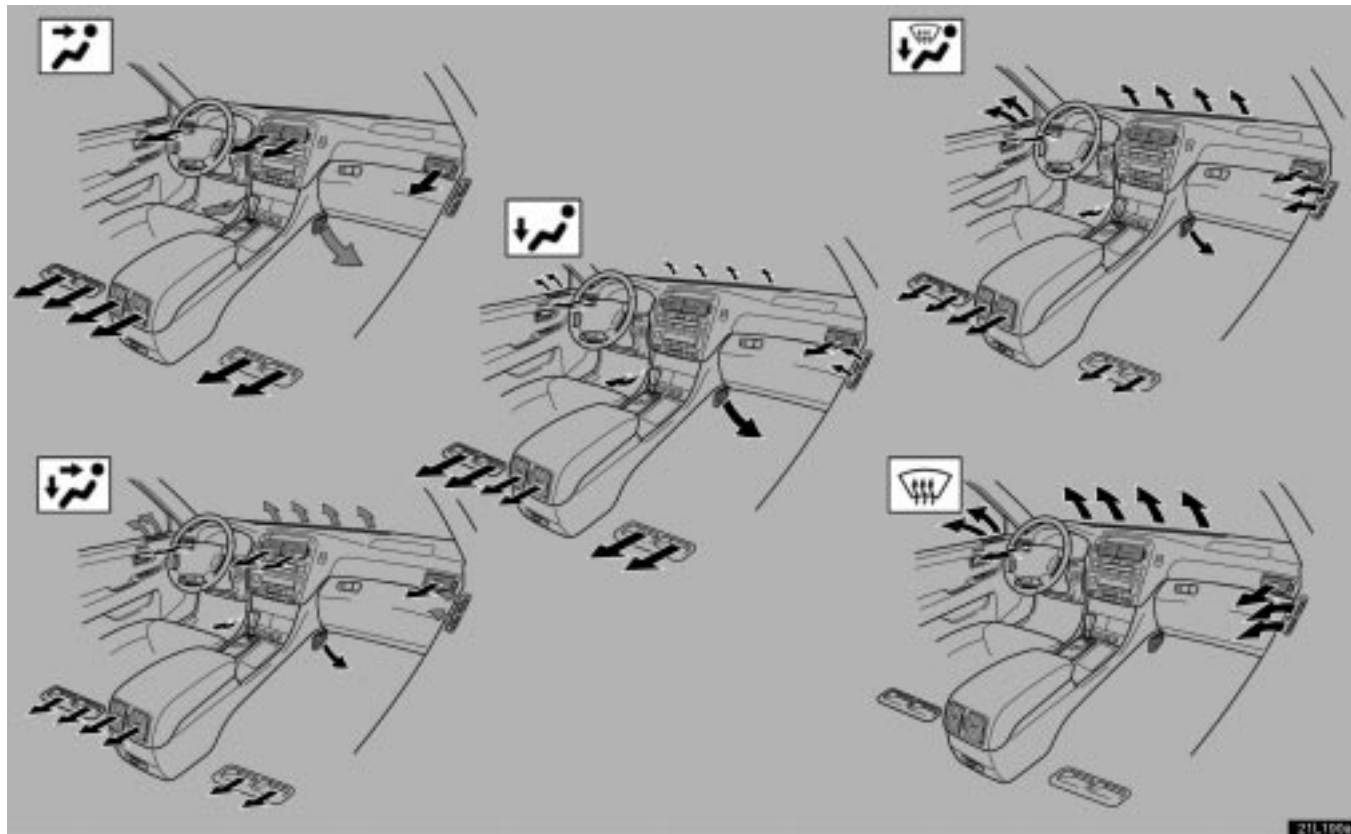

▶ Air flow selection

⇒ Automatic air flow mode only

AIR CONDITIONING

(a) Climate control

SETTING OPERATION - automatic control



1. Push the "AUTO" button.

Air flow quantity, switching of the diffusers, on-off of the air conditioning, and switching of the air intake between RECIRCULATED AIR and OUTSIDE AIR are automatically adjusted. If you use the air purifier automatic mode at the same time, air purifying effect will be enhanced (If equipped). The operation status is shown by each indicator.

When one of the manual control buttons is depressed while operating in automatic mode, the mode relevant to the depressed button is set. Other conditions continue to be adjusted automatically.

Push the "OFF" button briefly to turn the air conditioning off. If you keep the "OFF" button pushed, the data for the air filter is reset.



2. Use the "TEMP" or "PASSENGER TEMP" button to set the desired temperature.

The "TEMP" or "PASSENGER TEMP" button is used to set the desired temperature. The temperature will be controlled on the driver and front and rear passenger sides (if rear air conditioning is equipped) simultaneously or individually. The figures on the panel indicate degrees Fahrenheit or Centigrade.

"TEMP" button - Changes the temperature on the driver and front and rear passenger sides (if rear air conditioning is equipped) simultaneously or individually.

"PASSENGER TEMP" button - Changes the temperature settings separate from the driver side.

"DUAL" button - Changes the mode of the temperature setting.

AIR CONDITIONING

The indicator on the “DUAL” button has two modes:

- **With the indicator on** - For individual temperature setting
- **With the indicator off** - For simultaneous temperature setting

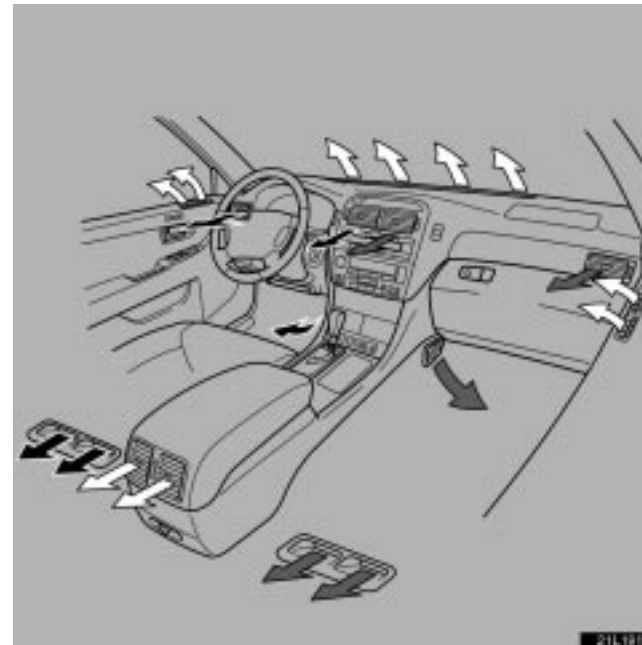

- ➔ Driver side setting
- ➔ Passenger side setting
- ➔ Mixed setting

AIR CONDITIONING

SETTING OPERATION - manual control

When one of the manual control buttons is depressed while operating in automatic mode, the mode relevant to the depressed button is set. Other conditions continue to be adjusted automatically.

If manual air flow selection is desired -

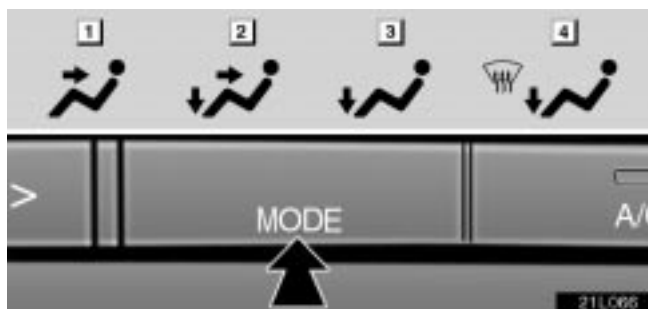

The outlets from which air is delivered can be selected manually by pushing the button. The function of each mode is as follows:

- 1 **Panel** - Air flows mainly from the instrument panel vents and rear vents.
- 2 **Bi-level** - Air flows from both the floor vents, the instrument panel vents and rear vents.
- 3 **Floor** - Air flows mainly from the floor vents and rear vents.
- 4 **Floor/Windshield** - Air flows mainly from the floor vents and windshield vents.

Take in the fresh air by selecting the OUTSIDE AIR mode with the air intake control button.

If quick heating or cooling is desired -

Push the "TEMP" or "PASSENGER TEMP" button on either side and hold it until "MAX. HOT" or "MAX. COLD" appears on the display.

If manual fan speed control is desired -

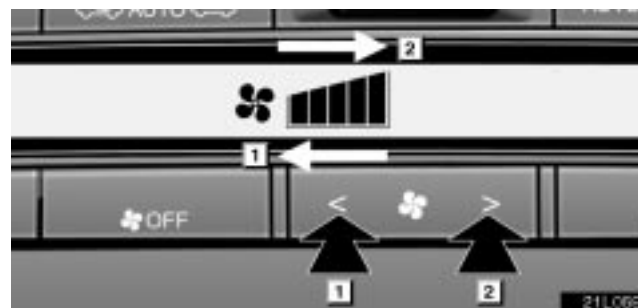

► 1 **Fan speed at low** 2 **Fan speed at high**

The fan speed can be set to your desired speed by pushing the appropriate side of fan speed control button. The higher the fan speed is, the more air is delivered. Pushing the "OFF" button briefly turns off the fan.

To remove exterior windshield frost, use the high speed setting.

AIR CONDITIONING

If manual switching of air intake is desired -

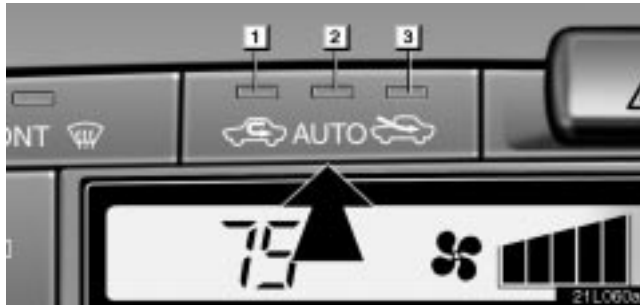

► Vehicles with rear air conditioning

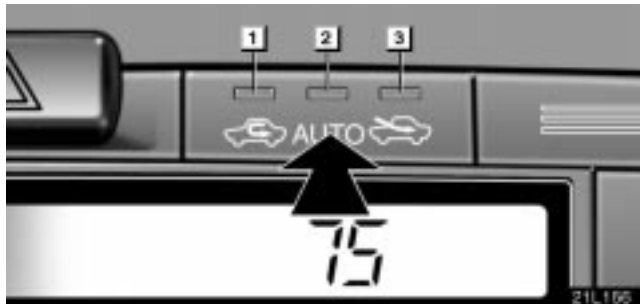

► Vehicles without rear air conditioning

Each time you push the air intake control button, the mode changes in order from the RECIRCULATED AIR mode to AUTOMATIC mode to OUTSIDE AIR mode, then back to the RECIRCULATED AIR mode. Each indicator light shows which mode is now selected.

- 1 RECIRCULATED mode** - If quick circulation of cooled air is desired, select this mode.
- 2 EXHAUST GAS AUTOMATIC mode** - If the outside air contains harmful substances like exhaust gas (i.e., when the vehicle running just in front of your vehicle accelerates rapidly), the system changes automatically from the OUTSIDE AIR mode (with indicators **2** and **3** on) to the RECIRCULATED mode (with indicators **1** and **2** on). If you use the EXHAUST GAS AUTOMATIC mode and the air purifier automatic mode at the same time, air purifying effect will be enhanced (If equipped).
- 3 OUTSIDE AIR mode** - The system will take fresh outside air into the vehicle.

Turning off the air conditioning manually will cancel the EXHAUST GAS AUTOMATIC mode. If you select the "AUTO" mode during fan operating, the air conditioning turns on and the EXHAUST GAS AUTOMATIC mode will operate.

For normal use, it is best to keep the air intake control button set to OUTSIDE AIR mode. If recirculated air is used during heating, the windows will fog up more easily.

To change the sensitivity of the sensor switching between the RECIRCULATED and OUTSIDE AIR in the AUTOMATIC mode, push the air intake control button until you hear a beep. The display changes as illustrated below.

AIR CONDITIONING

The sensitivity of the sensor can be adjusted only while the vehicle has stopped.



When you push either side of the “TEMP” button several times, the sensitivity changes from “+3” down to “-3”. If you do not operate any button for a few seconds, the previous display returns.

If manual on-off of the air conditioning is desired -

Push the “A/C” button to turn the air conditioning on and push it again to turn the air conditioning off. If you turn off the air conditioning manually, the EXHAUST GAS AUTOMATIC mode will be cancelled.

If the outside temperature is lowered down to around 0°C (32°F), the air conditioning will turn off automatically. At this time, the indicator on the A/C button is off and the EXHAUST GAS AUTOMATIC indicator light remains on. However, the EXHAUST GAS AUTOMATIC mode does not operate. When the air conditioning turns on as with the raised temperature, the EXHAUST GAS AUTOMATIC mode resumes.

If the system is used for ventilation, heating in dry weather or removing frost or exterior fog on the windshield, turn the air conditioning off once it is no longer required. This will improve fuel economy. The air conditioning can be used for year-round automatic temperature control including cooling and dehumidifying operation.

If the air conditioning compressor does not operate, the indicator of the “A/C” button will blink. If the indicator of the “A/C” button blinks even when the “A/C” button is pushed again, have the compressor checked by your nearest Lexus dealer.

(b) Windshield defogging and defrosting



To remove interior fog on the windshield -

Push the "FRONT WINDSHIELD" button.

To remove frost or exterior fog on the windshield -

1. Place the temperature control button at the maximum temperature.
2. Push the "FRONT WINDSHIELD" button.
3. Push the fan speed control button on the right side to obtain a maximum air flow.
4. Leave the "A/C" button off.

When the "FRONT WINDSHIELD" button is pushed while operating in automatic mode, the air conditioning is set to operate and the OUTSIDE AIR mode is set.

If you push the "FRONT WINDSHIELD" button once again while in the FRONT WINDSHIELD mode, the mode then returns to the last mode used.

 CAUTION
<p>Do not use the "FRONT WINDSHIELD" button during cooled air operation in extremely humid weather. The difference between the temperature of the outside air and that of the windshield could cause the outer surface of the windshield to fog up blocking your vision.</p>

When you turn the ignition switch on after the removal and installation of the battery terminal, the indicator light may flash and the operating sound of the motor may be heard. This does not indicate a malfunction.

You may hear the operating sound of the motor about 70 seconds after the ignition switch is turned off. This does not indicate a malfunction.

AIR CONDITIONING

(c) Replacing the air conditioning filter

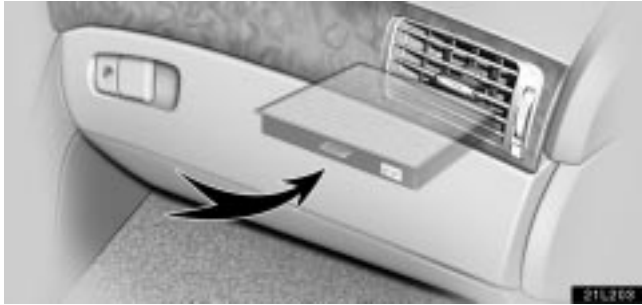

The air conditioning filter is behind the glove box.

The air conditioning filter prevents dust from entering the vehicle through the air conditioning vent.

If the "Change A/C Filter" appears on the multi-information display, change the air conditioning filter as soon as possible because the air filter might have clogged.

The filter may clog after long use which will reduce the air flow.

1. When you replace the filter, be sure to turn off the fan.

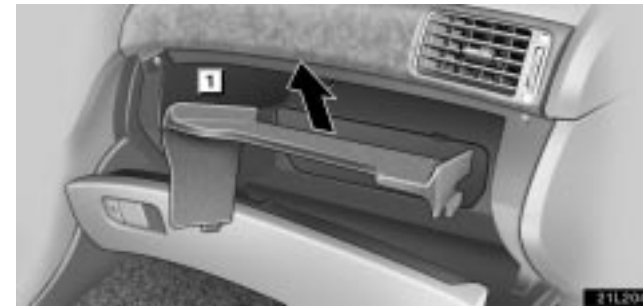

► **1 Partition**

2. Open the glove box and remove the partition.



► **1 Cover 2 Levers**

3. Push the levers and remove the cover.



► **1** Filter cover **2** Levers

4. Push up the levers and remove the filter cover.

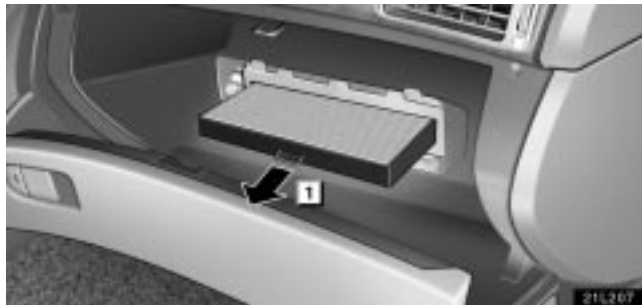

► **1** Filter case

5. Pull the filter case toward you.

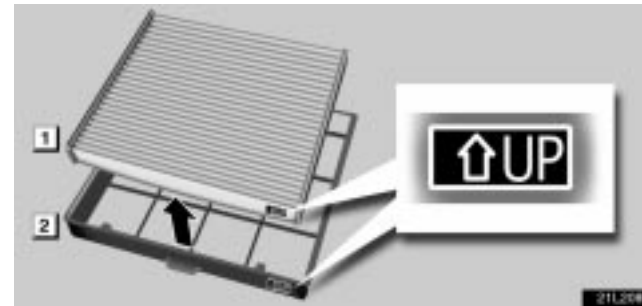

► **1** Filter **2** Filter case

6. Take the filter out of the filter case and replace it with a new one.

NOTICE

When installing, the UP marks shown on the filter and filter case should be noted and fitted as shown.

7. Install it in the reverse order of removal.

AIR CONDITIONING

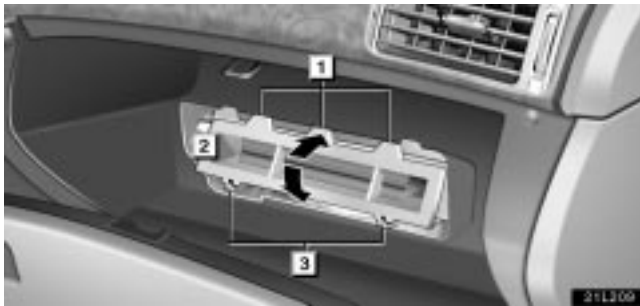

► **1** Tabs **2** Filter cover **3** Levers

8. When installing the filter cover, insert the 3 upper tabs and then 2 lower levers.



9. After the replacement, push and hold the “OFF” button for the front air conditioning for more than 4 seconds to reset the air filter clogging data. The “A/C Filter Reset” appears on the multi- information display and a tone sounds to inform you that the data has been reset.

NOTICE

The filter should be installed properly in position. The use of air conditioning with the filter removed may cause the malfunction of the air conditioning system.

(d) Operating tips

- Make sure the air inlet grilles in front of the windshield are not blocked by leaves or other obstructions.
- If air flow control is not satisfactory, check the dashboard vents. (See “Center vents”, “Side vents” and “Rear vents”.)
- To help cool down the interior after parking in the hot sun, drive for the first few minutes with the windows open. After the excess heat has blown away, close the windows.
- When driving on dusty roads, close all windows. If dust thrown up by the vehicle is still drawn into the vehicle after closing the windows, it is recommended that the air intake control button be left to the OUTSIDE AIR mode and the fan speed control button be pressed to anywhere except the “OFF” button.
- If following another vehicle on a dusty road, or driving in windy and dusty conditions, it is recommended that the air intake control button be temporarily pressed in to the RECIRCULATED AIR mode, which will close off the outside passage and prevent outside air and dust from entering the vehicle interior.

Center vents



The center vents may be opened or closed as shown.

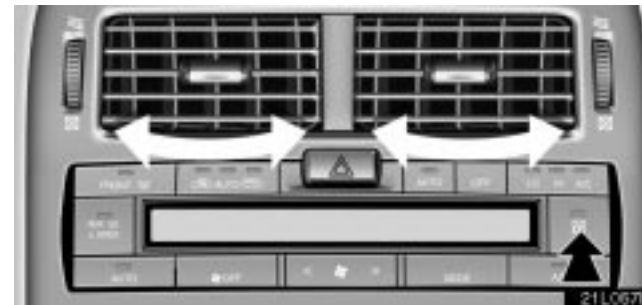

Push the swing button to swing the vanes.

The vanes directly aimed at the driver and front passenger will swing wider as the room temperature nears the desired temperature. The swinging angle will also change from narrow to wide depending on the room temperature.

AIR CONDITIONING



When you push the swing button with no passenger in the front seat and the “DUAL” button ON (with the indicator on):

The vanes directly aimed at the driver and rear passenger will swing wider as the room temperature nears the desired temperature. The swinging angle will also change from narrow to wide depending on the room temperature.

When you push the swing button with no passenger on the front seat and “DUAL” button OFF (with the indicator off):

The vanes directly aimed at the driver will swing wider as the room temperature nears the desired temperature. The swinging angle will also change from narrow to wide depending on the room temperature.

Side vents



The side vents may be opened or closed as shown.

Rear vents



The rear vents may be opened or closed as shown.

REAR AIR CONDITIONING CONTROLS

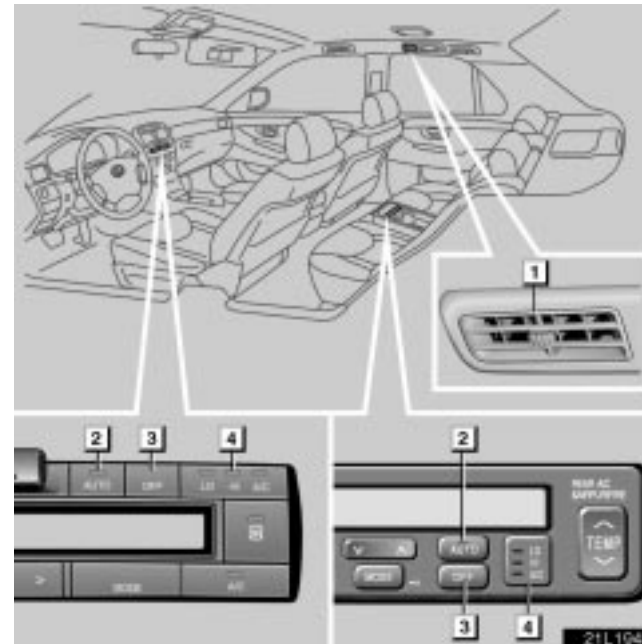

- ▶ **1** Rear air vent
- 2** Auto button
- 3** Off button
- 4** LO HI A/C button

AIR CONDITIONING

These are the controls added to the front air conditioning when your vehicle is equipped with a rear air conditioning. The controls for the rear passengers and for the front passengers both work the same, so operation can be made with the controls on either panel.

(a) Controls and Functions

This rear air conditioning is equipped with dustproof and deodorant filter with photocatalyst. When light in the xenon tube (ultraviolet rays) hits the filter, odious ingredients adsorbed in the filter are oxidized and decomposed to deliver clean air in the interior.

REAR AIR CONDITIONING ON-OFF -

Push the "AUTO" button to turn the air conditioning on, and push the "OFF" button to turn it off.

AIR FLOW CONTROL -

The mode changes every time the "LO HI A/C" button is pushed.

AUTO mode - Turns the fan operation to automatic.

LO speed mode - Turns the fan at low speed.

HI speed mode - Turns the fan at high speed.

(b) Rear Cooling

1. Turn the front air conditioning on. The rear cooler will not turn on if the front air conditioning is off.

2. Turn the rear air conditioning on. The fan speed and rear cooler are adjusted automatically.

3. Use either of the "LO HI A/C" buttons to adjust the desired fan speed and the rear cooler. Each indicator light shows which mode is now selected.

(c) Air Purification

The air purifier operates whenever the rear air conditioning or the rear fan operation is on, regardless of front air conditioning activation.

(d) Replacing the photocatalyst filter for the rear seats

This rear air conditioning is equipped with dustproof and deodorant filter with photocatalyst.

Replace the air filter when the use of rear air conditioning or air purification function reduces air flow or deodorant performance.

This filter is an interchangeable type. Do not clean the filter by washing or air blowing. The use of filter after washing or cleaning may cause a malfunction of the system. Be sure to replace it with a new one.

The filter is located in the trunk.

Replace the filter using the following procedures.

1. Be sure to turn the ignition switch to "LOCK".

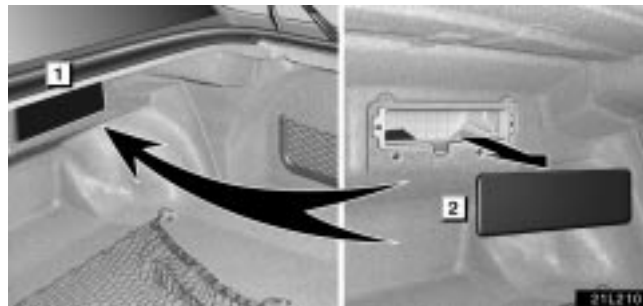

► **1 Air purifier** **2 Filter cover**

2. Open the trunk and remove the filter cover in the trunk.

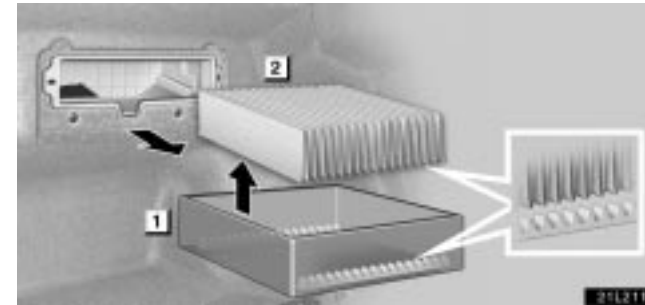

► **1 Filter case** **2 Filter**

3. Pull out the filter case toward you.
4. Replace the filter.

When you install the filter, face the filter surface (gray) downward and fit the filter folds properly in the case as shown.

5. Install the filter in the reverse order of removal.

The gray surface in the filter may turn to yellow (yellow spots) because of ultraviolet rays included in the light, however it is no problem for use.

AIR CONDITIONING

When the ignition switch is turned on, the xenon tube comes on even if the rear air conditioning or rear fan is not operating. This does not indicate a malfunction but is required for the long use of the photocatalyst.

NOTICE

- *Do not look into the xenon tube in the air purifier through the filter slot and do not expose your skin directly to the light in the xenon tube also. Although the xenon tube scarcely issues less than 300nm ultraviolet rays which are thought harmful for the human body, some people may have symptoms such as eye sore, vision trouble, skin inflammation, etc.*
- *Do not disassemble the air purifier, or it may cause a malfunction. As some part in the purifier is under high voltage, you may get an electric shock when you touch it.*
- *The filters should be installed properly in position. The use of rear air conditioning controls with the filter removed may cause the malfunction of the rear air conditioning controls.*
- *Turn on the air conditioning with a filter in position. The activation without an filter may not only cause a malfunction of the system but also dirty the interior by spouting dust.*

i

SECTION 2-2

AIR CONDITIONING AND AUDIO

Audio

Audio system 257

*For vehicles equipped with Navigation System,
please refer to the separate "Navigation System
Owner's Manual".*

AUDIO SYSTEM

Quick reference for your audio system



► If a Mark Levinson brand audio system is installed, the “Mark Levinson” logo is shown on the panel.

AUDIO

1 **Turning the system on and adjusting the volume**
(See page 259 for details.)

2 **Stopping and ejecting a cassette tape**
(See page 276 for details.)

3 **Function buttons**

1 - 6: Station selector buttons
(See page 265 for details.)

SCAN: Scan tuning
(See page 266 for details.)

4 **Display of functions in TAPE or CD mode**

◀▶: Side change
(See page 277 for details.)

□□: DOLBY NR
(See page 276 for details.)

◀◀: Rewinding or reversing
(See page 277 or 282 for details.)

▶▶: Fast forwarding
(See page 277 or 282 for details.)

RPT: Automatic repeat
(See page 277 or 282 for details.)

SKIP: Automatic skip of blank portions of tape
(See page 277 for details.)

v ▲: Disc selection
(See page 281 for details.)

RAND: Random access
(See page 283 for details.)

5 **Radio text**
(See page 268 for details.)

6 **Radio mode:** Frequency tuning
(See page 264 or 266 for details.)

TAPE mode: Direct access to a desired program
(See page 278 for details.)

DISC mode: Direct access to a desired program
(See page 282 for details.)

7 **Cassette tape slot**
(See page 276 for details.)

8 **Tone and balance knobs**
(See page 260 for details.)

9 **Program type/Traffic program**
(See page 267 for details.)

10 **Mode selectors**
(See page 259 for details.)

11 **Compact disc load button**
(See page 279 for details.)

12 **Compact disc slot**
(See page 279 for details.)

13 **Ejecting a compact disc**
(See page 280 for details.)

14 **Automatic sound levelizer/Positioning selector**
(See page 261 for details.)

Using your audio system: some basics

This section describes some of the basic features of the Lexus audio system. Some information may not pertain to your system.

Your audio system works when the ignition switch is in the "ACC" or "ON" position.

NOTICE

To prevent the battery from being discharged, do not leave the car audio on longer than necessary when the engine is not running.

(a) Turning the system on and off



Push this knob to turn the audio system on and off. Turn this knob to adjust the volume.

The system turns on in the last mode used.



Push the "AM-SAT", "FM", "TAPE" or "DISC" to turn on that mode. The selected mode turns on directly.

Push these buttons if you want to switch from one mode to another.

If the tape or disc is not set, the cassette player or compact disc player does not turn on.

You can turn off the cassette player by ejecting the cassette tape. If the audio system was previously off, then the entire audio system will be turned off when you eject the cassette tape. If another function was previously playing, it will come on again.

AUDIO



In the “TAPE” or “CD” mode, the applicable functions are shown in the lowest part of the display. Push the switch just below to turn on each function.

(b) Tone and balance

How good an audio program sounds to you is largely determined by the mix of the treble, mid-range, and bass levels. In fact, different kinds of music and vocal programs usually sound better with different mixes of treble, mid-range, and bass.

A good balance of the left and right stereo channels and of the front and rear sound levels is also important.

Keep in mind that if you are listening to a stereo recording or broadcast, changing the right/left balance will increase the volume of one group of sounds while decreasing the volume of another.



“**BALANCE**” knob: Use this knob to adjust the sound balance between the right and left speakers.

“**FADER**” knob: Use this knob to adjust the sound balance between the front and rear speakers.

“**BASS**” knob: Use this knob to adjust low-pitched tones.

“**MID**” knob: Use this knob to adjust mid-pitched tones.

“**TREBLE**” knob: Use this knob to adjust high-pitched tones.

(c) DSP Control

- Automatic sound levelizer



When the audio sound becomes difficult to be heard due to road noise, wind noise, etc. during driving, push the “ASL” button. The system adjusts to the optimum volume and tone quality according to the noise level. While the automatic sound levelizer is on, “ASL” appears on the display.

- Positioning selector



By selecting the listening position, the system controls the output timing of the speakers to allow sound to be heard evenly, creating the ideal music environment.

Each time you push the “POS” button, the position changes as in the following and the letter displays for 6 seconds on the screen.

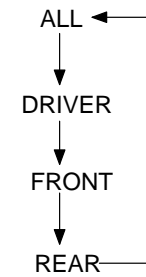

AUDIO

(d) Your radio antenna

The wire antenna is mounted inside the rear window.

NOTICE

- *When cleaning the inside of the rear window, be careful not to scratch or damage the wire antenna.*
- *Putting a window tint (especially, conductive or metallic type) on the rear window may affect the reception of radio or mobile telephone. For the installation of the window tint, consult with your Lexus dealer.*

(e) Your cassette player

When you insert a cassette, the exposed tape should be to the right.

NOTICE

Do not oil any part of the cassette player, and do not insert anything except a cassette tape into the slot.

(f) Your automatic changer



To use the automatic changer, push the panel.

**NOTICE**

Do not put any object on the panel or push it hard. Doing this may damage the panel.



Your automatic changer can store up to 6 discs and play selected discs or continuously play all the discs set in the player.

When you set discs into the player, make sure their labels face up. If not, the player will display "ERROR1" and the disc number.

NOTICE

- *Never try to disassemble or oil any part of the compact disc player. Do not insert anything except a compact disc into the slot.*
- *Do not insert a disc upon another one, or it will damage the automatic changer. Insert only one disc into the slot at a time.*

AUDIO

- The following products may not be playable on your compact disc player.
Copy-protected CD
CD-R (CD-Recordable)
CD-R W (CD-Re-writable)
CD-ROM
- Your compact disc player is intended for use with 12 cm (4.7 in.) discs only.

Radio operation

(a) Listening to the radio



Push these buttons to choose either an AM or FM station.

“AM”, “FM1”, “FM2” or “FM TYPE” appears on the display.

If your vehicle is equipped with satellite radio broadcast system, when you push the “AM-SAT” button, “AM”, “SAT1”, “SAT2” or “SAT3” station appears on the display. For details about satellite radio broadcast, see “Radio operation (XM satellite radio broadcast)” on page 269

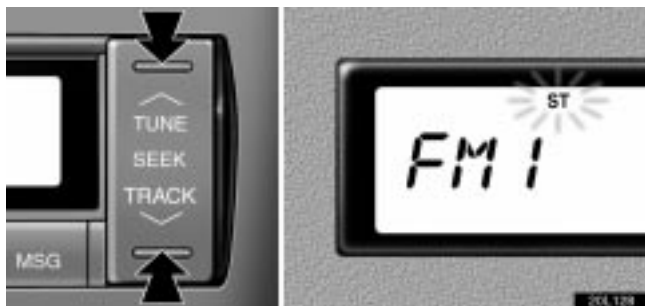

Push this button on the upper side to step up the station band or on the lower side to step down.

Your radio automatically changes to stereo reception when a stereo broadcast is received. "ST" appears on the display. If the signal becomes weak, the radio reduces the amount of channel separation to prevent the weak signal from creating noise. If the signal becomes extremely weak, the radio switches from stereo to mono reception. In this case, "ST" disappears from the display.

(b) Presetting a station



- 1. Tune in the desired station.**
- 2. Push one of the station selector buttons (1-6) and hold it until a beep is heard. This sets the station to the button and the button number (1-6) appears on the display.**

Each button can store one AM station and two FM stations. To change the preset station to a different one, follow the same procedure.

The preset station memory is cancelled when the power source is interrupted by battery disconnection or a blown fuse.

AUDIO

(c) Selecting a station

Tune in the desired station using one of the following methods.



Preset tuning: Push the button (1-6) for the station you want. The button number (1-6) and station frequency appear on the display.

Manual tuning: Push the “TUNE SEEK” button briefly. Each time you push the button, the radio will step up or down to another frequency.

Seek tuning: Push the “TUNE SEEK” button and hold it until you hear a beep. The radio will begin seeking up or down for a station of the nearest frequency and will stop on reception. Each time you push the button, the stations will be searched automatically one after another.



To scan all the frequencies: Push the “SCAN” button briefly. “SCAN” appears on the display. The radio will find the next station up the band, stay there for a few seconds, and then scan again. To select a station, push the “SCAN” button a second time.

To scan the preset stations: Push the “SCAN” button and hold it until you hear a beep. “P.SCAN” appears on the display. The radio will tune in the next preset station up the band, stay there for a few seconds, and then move to the next preset station. To select a station, push the “SCAN” button a second time.

(d) RDS (Radio Data System)**Program type:**

When you push the TYPE “v” or “^” button, the current program type receiving from the RDS station appears on the display.

If the radio receives no RDS stations, “NO PTY” appears on the display.

Each time you push the TYPE “v” or “^” button, the program type changes as in the following:

- ROCK
- EASY LIS (Easy listening)
- CLS/JAZZ (Classical music and jazz)
- R&B (Rhythm and Blues)
- INFORM (Information)
- RELIGION

- MISC
- ALERT (Emergency message)

While you are listening to a program type, you can operate the “TUNE SEEK” or “SCAN” function.



Push the “TUNE SEEK” or “SCAN” button. The radio seeks or scans the station in the relevant program type. (See page 266 for details.)

AUDIO

Traffic program: A station that regularly broadcasts traffic information is automatically located.

When you push the “TRAF” button, “TRAF SEEK” appears on the display and the radio will start seeking any traffic program station.

If no traffic program station is found, “NO TRAF INFO” appears on the display for a few seconds and the display returns to the previous mode.

Radio text:



If the radio receives radio text, “MSG” appears on the display. When you push the “MSG” button, a message is displayed.

In case a message is more than a line, hold the “MSG” button. The rest of the message is displayed.

When the system can show the station name, “RDS” appears on the display. Each time you push the “MSG” button, the indication changes from the band to the station name to radio text in this order. After six seconds, the indication returns to the band.

Radio operation (XM satellite radio broadcast)

To listen to a satellite radio broadcast in your vehicle, an additional genuine Toyota satellite receiver and antenna (or equivalents) must be purchased and installed. A subscription to the XM satellite radio service is also necessary.

(a) How to subscribe to an XM satellite radio

An XM satellite radio is a tuner designed exclusively to receive broadcasts provided under a separate subscription. Availability is limited to the 48 contiguous states.

How to subscribe:

You must enter into a separate service agreement with the XM radio in order to receive satellite broadcast programming in the vehicle. Additional activation and service subscription fees apply that are not included in the purchase price of the vehicle and optional digital satellite tuner. For complete information on subscription rates and terms, or to subscribe to the XM radio, visit XM on the web at www.xmradio.com or call an XM's Listener Care at (800) 852-9696. The XM radio is solely responsible for the quality, availability and content of the satellite radio services provided, which are subject to the terms and conditions of the XM radio customer service agreement.

Customers should have their radio ID ready; the radio ID can be found by tuning to "channel 000" on the radio. For details, see "Displaying the radio ID" below.

All fees and programming are the responsibility of the XM satellite radio and are subject to change.

Satellite tuner technology notice:

Toyota's satellite radio tuners are awarded Type Approval Certificates from XM Satellite Radio Inc. on "March 10, 2003" and "April 15, 2003" as proof of compatibility with the services offered by the XM satellite radio.

(b) Displaying the radio ID

Each XM tuner is identified with a unique radio ID. You will need the radio ID when activating XM service or when reporting a problem.

If you select the "CH 000" using the "TUNE" button, the ID code of 8 alphanumeric characters appears. If you select another channel, display of the ID code is canceled. The channel (000) alternates the display between the radio ID and the specific radio ID code.

AUDIO

(c) Listening to the satellite radio



Push the “AM-SAT” button to choose a SAT station.

Besides “AM”, “SAT1”, “SAT2” or “SAT3” appears on the display.



Push this button to select the next or previous channel.

If you push and hold the button, you can rapidly scroll forward or down through the channels. When displaying the channel category by the “TYPE” button, pushing the “TUNE SEEK” button lets you select the next or previous channel within the currently selected type.

(d) Presetting a channel

1. Tune in the desired channel.

2. Push one of the channel selector buttons (1-6) and hold it until a beep is heard. This sets the channel to the button and the button number (1-6) appears on the display.

Each button can store three SAT channels. To change the preset channel to a different one, follow the same procedure.

The preset channel memory is cancelled when the power source is interrupted by battery disconnection or a blown fuse.

(e) Selecting a channel

Tune in the desired channel using one of the following methods.



Preset tuning: Push the button (1-6) for the channel you want. The button number (1-6) and channel number appear on the display.

AUDIO



To scan the currently selected channel category : Push the "SCAN" button briefly. "SCAN" appears on the display. The radio will find the next channel in the same channel category up the band, stay there for a few seconds, and then scan again. To select a channel, push the "SCAN" button a second time.

To scan the preset channels: Push the "SCAN" button and hold it until you hear a beep. "P.SCAN" appears on the display. The radio will tune in the next preset channel, stay there for a few seconds, and then move to the next preset channel. To select a channel, push the "SCAN" button a second time.

(f) Channel category



When you push the TYPE "v" or "A" button, the current channel category appears on the display.

When the channel category appears, push either "v" or "A" button to switch to the next or previous category.

(g) Displaying the title and name

When you push the "MSG" button, the display changes as follows:

CH NAME ⇒ TITLE (SONG/PROGRAM TITLE) ⇒ NAME
(ARTIST NAME/FEATURE) ⇒ CH NUMBER ⇒ CH NAME

Up to 10 alphanumeric characters can be displayed. (Some information will not be fully displayed.)

AUDIO

(h) If the satellite radio tuner malfunctions

When problems occur with the XM tuner, a message will appear on the display. Referring to the table below to identify the problem, take the suggested corrective action.

ANTENNA	The XM antenna is not connected. Check whether the XM antenna cable is attached securely.
	A short-circuit occurs in the antenna or the surrounding antenna cable. See a Lexus certified dealer.
UPDATING	You have not subscribed to the XM satellite radio. The radio is being updated with the latest encryption code. Contact the XM satellite radio for subscription information. When a contact is canceled, you can choose the "CH000" and all free-to-air channels.
	The premium channel you selected is not authorized. Wait for about 2 seconds until the radio returns to the previous channel or "CH001". If it does not change automatically, select another channel. If you want to listen to the premium channel, contact the XM satellite radio.
NO SIGNAL	The XM signal is too weak at the current location. Wait until your vehicle reaches a location with a stronger signal.
LOADING	The unit is acquiring audio or program information. Wait until the unit has received the information.
OFF AIR	The channel you selected is not broadcasting any programming. Select another channel.
-----	There is no song/program title or artist name/feature associated with the channel at that time. No action needed.
---	The channel you selected is no longer available. Wait for about 2 seconds until the radio returns to the previous channel or "CH001". If it does not change automatically, select another channel.

The XM Listener Care Center is also available on the phone, please call (800) 852-9696 during the following hours:
 Monday – Saturday: 7 a.m. – 1 a.m. Sunday: 12 p.m – 12 a.m.

NOTICE

This equipment has been tested and found to comply with the limits for a class B digital device, pursuant to Part 15 of the FCC Rules. These limits are designed to provide reasonable protection against harmful interference in a residential installation. This equipment generates, uses and can radiate radio frequency energy and, if not installed and used in accordance with the instructions, may cause harmful interference to radio communications. However, there is no guarantee that interference will not occur in a particular installation.

If this equipment does cause harmful interference to radio or television reception, which can be determined by turning the equipment off and on, the user is encouraged to try to correct the interference by one or more of the following measures:

- Reorient or relocate the receiving antenna.*
- Increase the separation between the equipment and receiver.*
- Connect the equipment into an outlet on a circuit different from that to which the receiver is connected.*
- Consult the dealer or an experienced radio/TV technician for help.*

Information to user

Alternation or modifications carried out without appropriate authorization may invalidate the user's right to operate the equipment.

NOTICE

This XM tuner supports "Audio Services" (Music and Talk) of only XM satellite radio and "Text Information" linked to the respective audio services.*

**Text Information includes, Channel Name, (Artist) Name, (Song) Title and Category Name.*

AUDIO

Cassette tape player operation

(a) Playing a cassette tape



When you insert a cassette tape, the exposed tape should face to the right.

The player will automatically start when you insert a cassette tape. At this time, "TAPE" appears on the display.

If a metal or chrome equivalent cassette tape is put in the cassette player, the player will automatically recognize it, and "METAL" appears on the display.

To stop or eject the cassette tape, push the "▲" (eject) button.

Auto-reverse feature: After the cassette player reaches the end of a tape, it automatically reverses and begins to play the other side, regardless of whether the cassette was playing or fast forwarding.



If a cassette is already in the slot, push the "TAPE" button.

Dolby® Noise Reduction* feature: If you are listening to a tape that was recorded with Dolby® Noise Reduction*, push the "NR" button. The display will indicate that the Dolby noise reduction system is on.

The Dolby NR mode reduces tape noise by about 10 dB. For best sound reproduction, play your tapes with the Dolby NR on or off according to the mode used for recording the tape.

To play a tape recorded without Dolby NR, push the button again to turn off the Dolby NR.

* Dolby noise reduction manufactured under license from Dolby Laboratories Licensing Corporation. "DOLBY" and the double-D symbol  are trademarks of Dolby Laboratories Licensing Corporation.

(b) Manual program selection

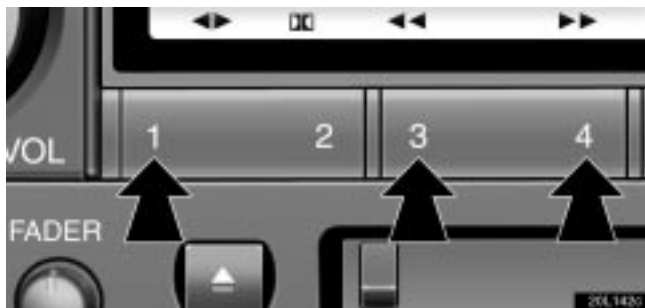

“Program” button: Push the “◀▶” button to select the other side of a cassette tape. The display indicates which side is currently selected (▲ indicates top side, ▼ indicates bottom side).

“Rewind” button: Push the “◀◀” button to rewind a tape. “REW” appears on the display.

To stop rewinding, push the same button or “TAPE” button.

“Fast forward” button: Push the “▶▶” button to fast forward a cassette tape. “FF” appears on the display.

To stop fast forwarding, push the same button or “TAPE” button.

(c) Automatic program selection

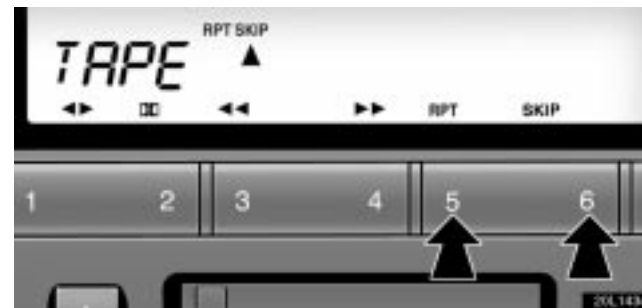

“RPT” button: The repeat feature automatically replays the current program.

Push the “RPT” button while the program is playing. When the program ends, it will automatically be rewound and replayed. Push the button again to turn off the repeat feature.

There must be at least 4 seconds of blank space between programs for the repeat feature to work correctly.

“SKIP” button: The skip feature allows you to fast forward past long stretches of blank tape. This is especially useful at the end of cassettes.

Push the “SKIP” button. The player will automatically skip any blank portions of 15 seconds or more and play the next program. To cancel it, push the button once again.

AUDIO



“Automatic program selection” button: The automatic program selection feature allows you to program your cassette player to skip forward or backward to locate the song you want to hear. You can skip up to nine programs at a time.

Push this button on the upper side to skip forward. “FF” and the number will appear on the display. Push the button until the number you want to skip appears on the display. After that, the player will automatically skip forward.

When the end of the tape is reached, the player automatically reverses sides and resumes normal play.

Push this button on the lower side to skip backward. Push the button until “REW” and the number you want to skip appear on the display.

- If you set “REW 1”, the player will rewind to the beginning of the current program.
- When counting the number of programs you want to rewind, remember to count the current program as well. For example, if you want to rewind to a song that is two before the song you are listening to, push this button until “REW 3” appears on the display.

When the beginning of the tape is reached, the player automatically resumes normal play.

There must be at least 3 seconds of blank space between programs for this feature to work correctly.

“RPT”, “SKIP” or “Automatic program selection” features: These features may not work well with some spoken word, live or classical recordings.

Compact disc player operation

(a) Inserting or ejecting compact discs

The ignition switch must be in the "ACC" or "ON" position.

Your automatic changer can store up to 6 discs.



- **Setting a single compact disc:**

- 1. Push the "LOAD" button briefly.**

The green indicators at both ends of the slot start blinking and "WAIT" appears on the display. After the blinking indicators stay on and the "WAIT" changes to the "LOAD", the CD door opens.

- 2. Insert only one disc while the CD door is open.**

You can set a disc at the lowest empty disc number.

After insertion, the set disc is automatically loaded.

If the label faces down, the disc cannot be played. In this case, "ERROR1" and disc number appear on the display.

If you need to insert the next disc, repeat the same procedure to insert another disc.

- **Setting all the discs:**

- 1. Push the "LOAD" button until you hear a beep.**

The green indicators at both ends of the slot start blinking and "WAIT" appears on the display. After the blinking indicators stay on and the "WAIT" changes to the "LOAD", the CD door opens.

- 2. Insert only one disc while the CD door is open.**

The CD door closes and "WAIT" appears again.

- 3. Insert the next disc after the "WAIT" changes to the "LOAD" and the CD door opens.**

- 4. Repeat this procedure until you insert all the discs.**

To cancel the operation, push the "LOAD" or "DISC" button.

If you do not insert the discs within 15 seconds after pushing the "LOAD" button and "LOAD" is displayed, the operation will be canceled automatically.

NOTICE

Do not insert one disc stacked on top of another one or feed them in continuously, to prevent discs from getting stuck in the player.

AUDIO

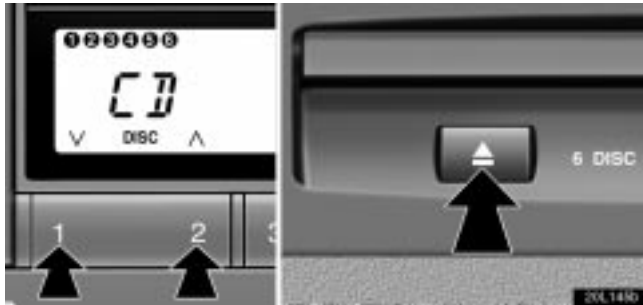

- **Ejecting a single disc:**

1. Push the button under the “v” or “^” signal on the display to display the disc number you want to eject.

2. Push the “▲” (eject) button briefly.

At this time, the display shows “EJECT” and the indicators at both ends of the slot as well as the disc number light up.

- **Ejecting all the discs:**

Push the “▲” (eject) button until you hear a beep.

However, if you accidentally pushed the “▲” (eject) button, push the “DISC” or “LOAD” button to insert the disc again.

Do not push in the disc which is being ejected forcibly.

(b) Playing a compact disc



Push the “DISC” button if the discs are already loaded in the player.

“CD” appears on the display.

The discs set in the player are played continuously, starting with the last disc you inserted. The disc number of the disc currently being played, the track number and the time from the beginning of the program appear on the display.

When play of one disc ends, the first track of the following disc starts. When play of the final disc ends, play of the first disc starts again.

The player will skip any empty disc number.

(c) Selecting a desired disc



Push the button under the “v” or “^” signal to select the disc number.

Push the button several times until the desired disc number appears on the display. When you release the button, the player will start playing the selected disc from the first track.

(d) Searching for a desired track or disc



Searching for a desired track:

Push the “SCAN” button briefly. “SCAN” will appear on the display. The compact disc player will play the next track for 10 seconds, then scan again. To select a track, push the “SCAN” button a second time. If the player reaches the end of the disc, it will continue scanning at track 1.

After all the tracks are scanned in one pass, normal play resumes.

Searching for a desired disc:

Push the “SCAN” button until you hear a beep. With “D.SCAN” on the display, the program at the beginning of each disc will be played for 10 seconds. To continue listening to the program of your choice, push the “SCAN” button a second time.

After all the discs in the automatic changer are scanned in one pass, the scan function is cancelled.

AUDIO

(e) Selecting a desired track



“TRACK” button: Use for direct access to a desired track.

Push either side of the “TRACK” button several times until the desired track number appears on the display. As you release the button, the player will start playing the selected track from the beginning.

“Fast forward” button: Push the “TRACK” button on the upper side and hold it to fast forward the disc. When you release the button, the compact disc player will resume playing from that position.

“Reverse” button: Push the “TRACK” button on the lower side and hold it to reverse the disc. When you release the button, the compact disc player will resume playing.

(f) Repeating a track or a disc



“RPT” button: There are 2 repeat features — you can either replay a disc track or a whole compact disc.

Repeating a track: Push the “RPT” button briefly while the track is playing. “RPT” will appear on the display. When the track ends, it will automatically be replayed. This process will be continued until you push the button again to turn off the repeat feature.

Repeating a disc: Push the “RPT” button and hold it until you hear a beep. “D.RPT” will appear on the display. The player will repeat all the tracks on the disc you are listening to. When the disc ends, the player will automatically go back to the first track on the disc and replay. This process will be continued until you push the button again to turn off the repeat feature.

(g) Random playing

“RAND” button: There are 2 random features — you can either listen to the tracks on all the compact discs in the player in random order, or only listen to the tracks on a specific compact disc in random order.

Random playing for the tracks on a disc: Push the “RAND” button briefly. “RAND” will appear on the display and play the disc you are listening to in random order.

Random playing for all the tracks in the automatic changer: Push the “RAND” button and hold it until you hear a beep. “D.RAND” will appear on the display and the player will perform all the tracks on all the discs in the automatic changer in random order. To turn off the random feature, push “RAND” a second time.

When a track is skipped or the system is inoperative, push the button to reset.

(h) If the player malfunctions

If the player or another unit equipped with the player malfunctions, your audio system will display one of the four following error messages.

If “WAIT” appears on the display, it indicates that the inside of the player unit may be too hot due to the very high ambient temperature. Remove the disc from the player and allow the player to cool down.

If “ERROR 1” appears on the display, it indicates that the disc is dirty, damaged, or it was inserted upside down. Clean the disc or insert it correctly.

If “ERROR 3” or “ERROR 4” appears on the display, it indicates there is trouble inside the system. Eject the disc.

If the malfunction is not rectified, take your vehicle to your Lexus dealer.

AUDIO

Rear controller (some models)

The rear controller is installed in the armrest of the rear center seat so that you can operate the audio system in the rear seat.



“POWER” button: Use this button to turn the system on and off.

“MODE” button: Use this button to change the mode. If a tape or compact disc is not inserted, the “TAPE” or “CD” mode is skipped.

You can lock the button operation. To activate the lock, push and hold the “MODE” button until you hear a beep. “LOCK” appears on the display. All the buttons in the rear controller are inoperative. To cancel it, push and hold the “MODE” button until you hear a beep again. You can use all the buttons.

“VOL” button: Use this button to adjust the volume.

(a) When the radio mode is selected

“CH” button: Push the “CH” button to select a station preset on the preset button of the front audio system. Each push of the button changes to the station with higher numbered preset button.

“v A” button: Push this button for manual tuning or seek tuning.

- Push this button briefly. Each time you push the button, the radio will step up or down to another frequency.
- Push this button and hold it until you hear a beep. The radio will begin seeking up or down for a station, and will stop on reception. Each time you push the button, the stations will be searched out one after another.

(b) When the “TAPE” mode is selected

The applicable functions are shown in the lowest part of the display. Push the switch just below to turn on each function. In the “CD” mode, “DISC” and “TRACK” are displayed.

“CH” button: Push this button to select the other side of a cassette tape.

“v A” button: Push the left or right side to skip forward or backward to locate the song you want to hear. For details, see “Automatic program selection” on page 277.

(c) When the “CD” mode is selected

“CH” button: Use this button to search a desired disc.

“v Λ” button: Use this button to search a desired track or push this button and hold it to fast forward or reverse.

Steering pad switches

The steering pad switches are installed on the left side of the steering wheel.

“MODE” switch: Use this switch to change the mode. If a tape or compact disc is not inserted, the “TAPE” or “CD” mode is skipped. When you push the switch with the audio system turned off, the audio system turns on.

“VOL” switches: Use these switches to adjust the volume. Push “Λ” to increase the volume and “v” to decrease the volume. The volume continues to increase or decrease while the switch is being pressed.

“SET” switch: Use this switch to adjust the preset volume. To preset the volume, adjust the volume and then push and hold this switch until you hear a beep.

AUDIO

(a) When the radio mode is selected

“▼” or “▲” switch: Push this switch for seek tuning or to select a station.

- Push this switch briefly to select a station that you assigned to a switch on the audio system.
- Push this switch and hold it until you hear a beep. The radio will begin seeking up or down for a station, and will stop on reception.

(b) When the “TAPE” mode is selected

“▼” or “▲” switch: Push this switch to fast forward or rewind the tape or for automatic program selection.

- Push this switch until you hear a beep to fast forward or rewind the tape. To stop fast forwarding or rewinding, push the same side on the switch until you hear a beep.
- Push this switch briefly for automatic program selection. When automatically selecting a program, you can skip up to 9 programs at a time. For details, see page 277 for details.

(c) When the “CD” mode is selected

“▼” or “▲” switch: Use this switch to select a desired track or disc.

- Push this switch briefly to select a desired track.
- To select a desired disc, push and hold this switch until you the desired number of the disc appears and you hear a beep.

CAUTION

Operate the steering pad switches with due care while you are driving to avoid accidents.

Car audio system operating hints

NOTICE

To ensure correct audio system operations:

- *Be careful not to spill beverages over the audio system.*
- *Do not put anything other than a cassette tape or compact disc into the cassette tape slot or compact disc slot.*
- *The use of a cellular phone inside or near the vehicle may cause a noise from the speakers of the audio system which you are listening to. However, this does not indicate a malfunction.*

Radio reception

Usually, a problem with radio reception does not mean there is a problem with your radio - it is just the normal result of conditions outside the vehicle.

For example, nearby buildings and terrain can interfere with FM reception. Power lines or telephone wires can interfere with AM signals. And of course, radio signals have a limited range. The farther you are from a station, the weaker its signal will be. In addition, reception conditions change constantly as your vehicle moves.

Here are some common reception problems that probably do not indicate a problem with your radio:

FM

Fading and drifting stations - Generally, the effective range of FM is about 40 km (25 miles). Once outside this range, you may notice fading and drifting, which increase with the distance from the radio transmitter. They are often accompanied by distortion.

Multi-path - FM signals are reflective, making it possible for two signals to reach your antenna at the same time. If this happens, the signals will cancel each other out, causing a momentary flutter or loss of reception.

Static and fluttering - These occur when signals are blocked by buildings, trees, or other large objects. Increasing the bass level may reduce static and fluttering.

Station swapping - If the FM signal you are listening to is interrupted or weakened, and there is another strong station nearby on the FM band, your radio may tune in the second station until the original signal can be picked up again.

AM

Fading - AM broadcasts are reflected by the upper atmosphere - especially at night. These reflected signals can interfere with those received directly from the radio station, causing the radio station to sound alternately strong and weak.

Station interference - When a reflected signal and a signal received directly from a radio station are very nearly the same frequency, they can interfere with each other, making it difficult to hear the broadcast.

Static - AM is easily affected by external sources of electrical noise, such as high tension power lines, lightening, or electrical motors. This results in static.

Caring for your cassette player and tapes

For the best performance for your cassette player and tapes:

Clean the tape head and other parts regularly.

- A dirty tape head or tape path can decrease sound quality and tangle your cassette tapes. The easiest way to clean them is by using a cleaning tape. (A wet type is recommended.)

AUDIO

Use high-quality cassettes:

- Low-quality cassette tapes can cause many problems, including poor sound, inconsistent playing speed, and constant auto-reversing. They can also get stuck or tangled in the cassette player.
- Do not use a cassette if it has been damaged or tangled or if its label is peeling off.
- Do not leave a cassette in the player if you are not listening to it, especially if it is hot outside.
- Store cassettes in their cases and out of direct sunlight.
- Avoid using cassettes with a total playing time longer than 100 minutes (50 minutes per side). The tape used in these cassettes is thin and could get stuck or tangled in the cassette player.

Caring for your compact disc player and discs

- Your compact disc player is intended for use with 12 cm (4.7 in.) discs only.
- Extremely high temperature can keep your compact disc player from working. On hot days, use air conditioning to cool the vehicle interior before you listen to a disc.
- Bumpy roads or other vibrations may make your compact disc player skip.
- If moisture gets into your compact disc player, you may not hear any sound even though your compact disc player appears to be working. Eject all discs from the player and wait until the player dries.



Compact disc players use an invisible laser beam which could cause hazardous radiation exposure if directed outside the unit. Be sure to operate the player correctly.



- Use only compact discs marked as shown above. The following products may not be playable on your compact disc player.

Copy-protected CD
CD-R (CD-Recordable)
CD-RW (CD-Re-writable)
CD-ROM



► **Special shaped discs**

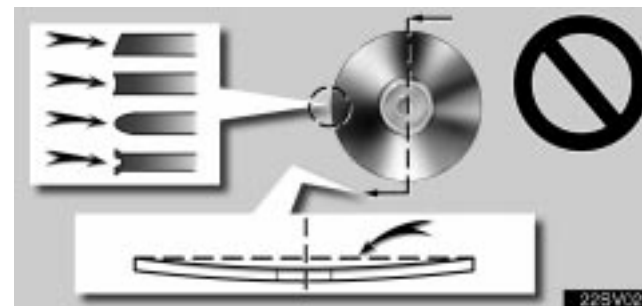

► **Low quality discs**

AUDIO



► **Labeled discs**

NOTICE

To prevent damage to the player or changer, do not use special shaped, low quality or labeled discs such as those shown in the illustrations.

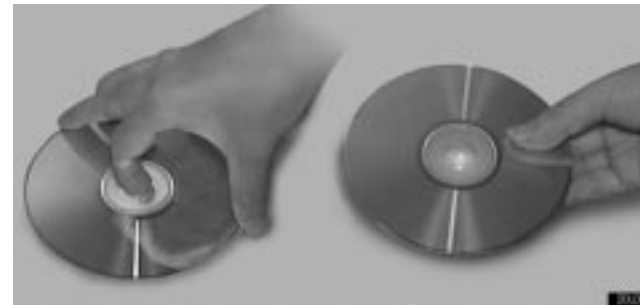

► **Correct**

► **Wrong**

- Handle compact discs carefully, especially when you set them into the player. Hold them on the edge and do not bend them. Avoid getting fingerprints on them, particularly on the shiny side.
- Dirt, scrapes, warping, pin holes, or other disc damage could cause the player to skip or to repeat a section of a track. (To see a pin hole, hold the disc up to the light.)



To clean a compact disc: Wipe it with a soft, lint-free cloth that has been dampened with water. Wipe in a straight line from the center to the edge of the disc (not in a circle). Do not use a conventional record cleaner or anti-static device.

SECTION 3-1

STARTING AND DRIVING

Starting and driving

Three-way catalytic converters	293
Engine exhaust caution	294
Before starting the engine	295
Smart ignition system with steering lock	295
Ignition switch with steering lock	298
Parking brake	299
How to start the engine	300
Automatic transmission	301
Electronic throttle control system	311
Lexus park assist system	312
Rear view monitor system	318
Cruise control	322
Dynamic radar/laser cruise control	325
Electronically modulated air suspension	355
Traction control system	357
Vehicle stability control system	360
Brake system	362
Tire pressure warning system	365
Brake pad wear limit indicators	369
Pre-collision safety system	369

THREE-WAY CATALYTIC CONVERTERS

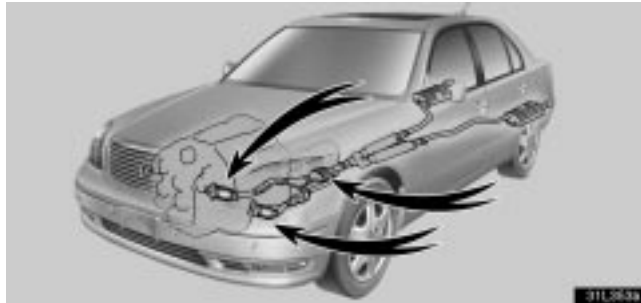

Three-way catalytic converters are emission control devices installed in the exhaust system.

The purpose is to reduce pollutants in the exhaust gas.

CAUTION

- Keep people and combustible materials away from the exhaust pipe while the engine is running. The exhaust gas is very hot.
- Do not drive, idle or park your vehicle over anything that might burn easily such as grass, leaves, paper or rags.

NOTICE

A large amount of unburned gases flowing into the three-way catalytic converter may cause it to overheat and create a fire hazard. To prevent this and other damage, observe the following precautions:

- *Use only unleaded gasoline.*
- *Do not drive with an extremely low fuel level; running out of fuel could cause the engine to misfire, creating an excessive load on the three-way catalytic converter.*
- *Do not allow the engine to run at idle speed for more than 20 minutes.*
- *Avoid racing the engine.*
- *Do not push-start or pull-start your vehicle.*
- *Do not turn off the ignition while the vehicle is moving.*
- *Keep your engine in good running order. Malfunctions in the engine electrical system, electronic ignition system or fuel system could cause an extremely high three-way catalytic converter temperature.*
- *If the engine becomes difficult to start or stalls frequently, take your vehicle in for a check-up as soon as possible. Remember, your Lexus dealer knows your vehicle and its three-way catalytic converter system best.*

STARTING AND DRIVING

- *To ensure that the three-way catalytic converter and the entire emission control system operate properly, your vehicle must receive the periodic inspections required by the Lexus Maintenance Schedule. For scheduled maintenance information, refer to the "Owner's Manual Supplement / Scheduled Maintenance".*

ENGINE EXHAUST CAUTION



CAUTION

- Avoid inhaling the engine exhaust. It contains carbon monoxide, which is a colorless and odorless gas. It can cause unconsciousness or even death.
- Make sure the exhaust system has no holes or loose connections. The system should be checked from time to time. If you hit something, or notice a change in the sound of the exhaust, have the system checked immediately.
- Do not run the engine in a garage or enclosed area except for the time needed to drive the vehicle in or out. The exhaust gases cannot escape, making this a particularly dangerous situation.
- Do not remain for a long time in a parked vehicle with the engine running. If it is unavoidable, however, do so only in an unconfined area and adjust the heating or cooling system to force outside air into the vehicle.

- Keep the trunk lid closed while driving. An open or unsealed trunk lid may cause exhaust gases to be drawn into the vehicle.
- To allow proper operation of your vehicle's ventilation system, keep the inlet grilles in front of the windshield clear of snow, leaves, or other obstructions.
- If you smell exhaust fumes in the vehicle, drive with the windows open and the trunk lid closed. Have the cause immediately located and corrected.

BEFORE STARTING THE ENGINE

1. Check the area around the vehicle before entering it.
2. Adjust seat cushion length, seat position, seatback angle, seat cushion angle, seat cushion height, head restraint height and steering wheel angle.
3. Adjust the inside and outside rear view mirrors.
4. Lock all doors.
5. Fasten seat belts.

Remember to check that the service reminder indicators function when turning the ignition switch to "ON", and check the fuel gauge to see that you have sufficient fuel.

SMART IGNITION SWITCH WITH STEERING LOCK



Carrying a smart key allows you to start the engine without the key being inserted into the ignition switch.

The smart key system can be deactivated using a smart cancel switch. For details, see "Deactivating the smart key system" on page 34.

STARTING AND DRIVING



When you enter the vehicle carrying a smart key and push the ignition switch, the electronic code in the key is automatically checked as to whether it corresponds to the registered ID code for the vehicle. The smart indicator light comes on, the steering column lock is released, and the engine immobilizer system is cancelled.

At this time, the security indicator light goes off and you can start the engine when you turn the ignition switch and the smart indicator light does not come on. When you turn the ignition switch, turn it slowly and surely. If you turn it quickly, it may become stuck. To free it, turn the steering wheel slightly in either direction with the ignition switch pushed in.

If you push the ignition switch when the smart key is not within the effective range of the smart key system, a warning tone sounds and "Key is not Detected" appears on the display.

"START" - Starter motor on. The ignition switch will return to the "ON" position when released.

For starting tips, see page 300.

"ON" - Engine on and all accessories on.

This is the normal driving position.

NOTICE

Do not leave the ignition switch in the "ON" position if the engine is not running. The battery will discharge and the electronic ignition system could be damaged.

"ACC" - Accessories such as the radio operate, but the engine is off.

STARTING AND DRIVING



“LOCK” - Engine is off and the steering wheel is locked.

When you leave your vehicle, be sure to turn the ignition switch to the “LOCK” position and carry the smart key.

- If you open the driver’s door without returning the ignition switch to the “LOCK” position, beeps keep sounding while the door is opened.
- If you close a door to leave your vehicle while carrying a key on which the ignition switch has not been returned to the “LOCK” position, “Key is not Detected” appears on the multi-information display, a warning tone sounds inside and beeps sound outside.
- If the selector lever is in a position other than “P”, you cannot turn the ignition switch to the “LOCK” position. At this time, when you open the driver’s door and are going to get out of the vehicle, “Shift to P Range” appears on the multi-information display and a warning tone sounds inside.

When you turn the ignition switch to the “LOCK” position, the engine immobilizer system is automatically set. See “Engine immobilizer system” on page 17.

If, in an emergency, you must turn the engine off while the vehicle is moving, turn the ignition switch only to “ACC”.

STARTING AND DRIVING

IGNITION SWITCH WITH STEERING LOCK

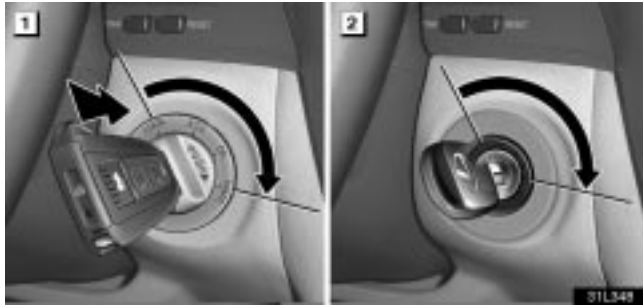

► **1** Type A **2** Type B

Type A: Insert the key, push and turn it to each position.

Type B: Insert the key and turn it to each position.

“START” - Starter motor on. The key will return to the **“ON”** position when released.

For starting tips, see page 300.

“ON” - Engine on and all accessories on.

This is the normal driving position.

NOTICE

Do not leave the key in the “ON” position if the engine is not running. The battery will discharge and the electronic ignition system could be damaged.

“ACC” - Accessories such as the radio operate, but the engine is off.

If you leave the key in the “ACC” or “LOCK” position and open the driver’s door, a buzzer will remind you to remove the key.*

NOTE:

** The volume or interval of beep sound can be changed. Ask your Lexus dealer for details.*



► **1** Type A **2** Type B

“LOCK” - Engine is off and the steering wheel is locked. The ignition key can be removed only at this position.

To turn the ignition switch from “ACC” to the “LOCK” position, you must put the transmission selector lever in the “P” position.

Once you remove the key, the engine immobilizer system is automatically set. See “Engine immobilizer system” on page 17.

When starting the engine, the key may seem stuck at the “LOCK” position. To free it, first be sure the key is pushed all the way in, and then rock the steering wheel slightly while turning the key gently.

PARKING BRAKE

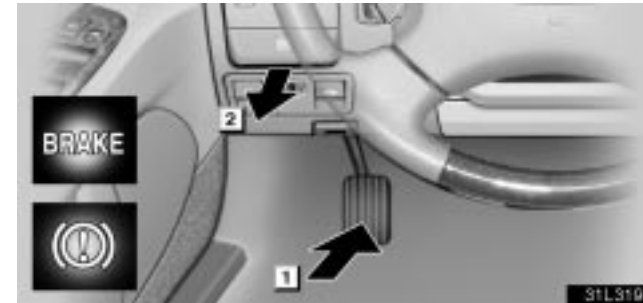

- 1** To set: Fully depress the parking brake pedal.
 - 2** To release: Pull the parking brake release lever.
- Before leaving your vehicle, firmly apply the parking brake.

⚠ CAUTION

Before driving, make sure the parking brake is fully released and that the parking brake reminder light is off.

STARTING AND DRIVING

HOW TO START THE ENGINE

Before cranking

1. Apply the parking brake firmly.
2. Turn off unnecessary lights and accessories.
3. Put the selector lever in "P". If you need to restart the engine while the vehicle is moving, put the selector lever in "N". A starter safety device will prevent the starter from operating if the selector lever is in any drive position.
4. Depress the brake pedal and hold it to the floor until driving off.

Starting the engine

Before starting the engine, be sure to follow the instructions in "Before cranking".

Normal starting procedure

The multiport fuel injection system/sequential multiport fuel injection system in your engine automatically controls the proper air-fuel mixture for starting. You can start a cold or hot engine as follows:

With your foot off the accelerator pedal, crank the engine by turning the ignition switch to "START". Release it when the engine starts.

The engine should be warmed up by driving, not in idle. For warming up, drive with smoothly turning engine until the engine coolant temperature is within normal range.

If the engine stalls ...

Simply restart it, using the correct procedure given in normal starting.

If the engine will not start

See "If your vehicle will not start" on page 395.

NOTICE

- ***Do not crank for more than 30 seconds at a time. This may overheat the starter and wiring systems.***
- ***Do not race a cold engine.***
- ***If the engine becomes difficult to start or stalls frequently, have the engine checked immediately.***

AUTOMATIC TRANSMISSION

Your automatic transmission has a shift lock system to minimize the possibility of incorrect operation. This means you can only shift out of “P” position when the brake pedal is depressed with the ignition switch in “ON” position. (★)



► *The shift position or shift range position is displayed on the instrument cluster.*

- P: Parking, engine starting and key removal position
- R: Reverse position
- N: Neutral position
- D: Normal driving position (Shifting into overdrive possible)
- S: “S” mode driving
 - + : Upshifting
 - : Downshifting

STARTING AND DRIVING

Correct use of the automatic transmission is explained in the following parts.

- (a) Normal driving
- (b) Driving in “S” mode
- (c) Using engine braking
- (d) Backing up
- (e) Parking
- (f) Good driving practice
- (g) If you cannot shift the selector lever

(a) Normal driving



► **1** “P” (Park) position **2** “N” (Neutral) position

1. Start the engine as instructed in “How to start the engine” on page 300.

The transmission must be in “P” or “N” position. The engine will not start in any drive position even if the ignition switch is turned to “START”.

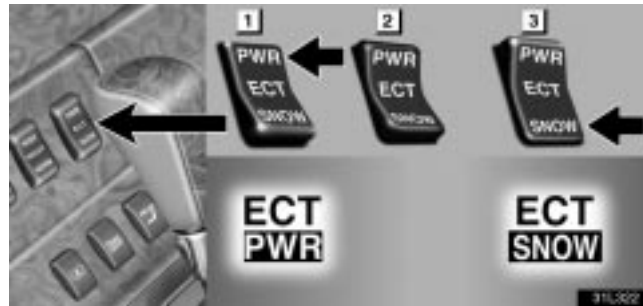

- **1** Power position **2** Normal position
3 Snow position

2. Set the driving pattern selector switch to the “Normal” position.

Your transmission has a driving pattern selector switch which allows you to select “Power”, “Normal” or “Snow” mode to suit your driving condition. For ordinary driving, Lexus recommends that you use the “Normal” position to improve fuel economy.

3. For more powerful acceleration and sporty driving, use the “Power” position.

In the “Power” position, the “ECT PWR” light in the instrument cluster is on and the transmission is shifted up at higher vehicle speeds and shifted down more responsively than in the “Normal” position.

For “Snow” mode, see “Electronic Throttle Control System” on page 311.



- **1** Brake pedal **2** “D” (Drive) position

4. With your foot holding down the brake pedal, shift the selector lever to “D”.

Always use the “D” position to improve fuel economy and quiet driving. Only in this position, shifting into the overdrive gear is possible. However, while the engine coolant temperature is low, the transmission will not shift into the overdrive gear even in the “D” position. (See “(c) Using engine braking” and “(f) Good driving practice” for exceptions.)

⚠ CAUTION

Never put your foot on the accelerator pedal while shifting.

STARTING AND DRIVING

5. Release the parking brake and brake pedal. Depress the accelerator pedal slowly for smooth starting.

In normal cruising, the vehicle will start in first gear and automatically shift up to the most suitable gear. On inclines, declines or winding roads, etc., the vehicle shifts up and down automatically according to the running conditions to obtain the suitable driving power and engine braking.

If you need to accelerate rapidly while driving, depress the accelerator pedal to the full throttle position. This provides more acceleration by automatically downshifting the transmission to the next lower gear or beyond, depending on the vehicle speed.

If engine braking is needed, such as in descending a long hill, see “(c) Using engine braking”.

● AI (Artificial Intelligence) shifting control

AI shifting control selects the most suitable shift range automatically according to the driver’s operation and driving condition.

AI shifting control operates automatically with the selector lever in the “D” position. When the lever is moved to the “S” position, this function will be canceled.

Shifting control on the slope: On inclines, you can drive smoothly with reduced shifting quantity. On declines, the vehicle will shift down automatically to obtain optimum engine braking and reduce the driver’s foot braking load.

Automatic shifting point change control: The most suitable shift range is selected depending on the driver’s accelerator pedal operation and vehicle condition.

(b) Driving in “S” mode



- ▶ 1 *Upshifting*
- ▶ 2 *Downshifting*
- ▶ 3 *“S” mode position*
- ▶ 4 *Shift range position indicator*

You can change the shift range position in the “S” mode. The shift range position can be switched between “6” (sixth range) and “1” (first range) by moving the selector lever up to the “+” side or down to the “-” side. The first shift range position is “5” (fifth range) when the selector lever is shifted to the “S” position.

However, if you move the lever to the “S” position in AI shifting control, “5” (fifth range), “4” (fourth range) or “3” (third range) will be the first shift range. This is because the suitable shift range is selected depending on the driving condition.



► **Shift range position indicator**

The shift range position is displayed on the instrument cluster.

● **Shift range positions**

“6” (sixth range): The most suitable gear is automatically selected between first and overdrive (sixth) gears according to vehicle speed and driving conditions. Always use the “6” (sixth range) position to improve fuel economy and for quiet driving.

“5” (fifth range): The most suitable gear is automatically selected between first and fifth gears according to vehicle speed and driving conditions. This range is suitable for acceleration such as when you want to pass a vehicle running ahead of you during high speed driving.

“4” (fourth range): The most suitable gear is automatically selected between first and fourth gears according to vehicle speed and driving conditions. In the “4” (fourth range) position, the automatic transmission system will select the most suitable gear to handle current running conditions such as hill climbing, hard towing, etc.

“3” (third range): The most suitable gear is automatically selected between first and third gears according to vehicle speed and driving conditions. This range is best used when stronger engine braking is necessary.

“2” (second range): First or second gear will automatically be selected according to vehicle speed and driving conditions. This range is to be used when engine braking stronger than that of the “3” (third range) position is necessary.

“1” (first range): This gear is fixed in first regardless of vehicle speed or driving conditions. This range is to be used when maximum engine braking is necessary.

If you attempt to downshift the transmission when it is not possible to downshift due to high vehicle speed, a warning tone sounds twice.

STARTING AND DRIVING

- **Maximum allowable speeds**

To get on a highway or to pass slower traffic, maximum acceleration may be necessary. Make sure you observe the following maximum allowable speeds in each range:

range	km/h (mph)
1	59 (36)
2	100 (62)
3	146 (90)

NOTICE

Do not downshift if you are going faster than the maximum allowable speed for the next lower range.

- **“S” mode indicator light**

“S” mode allows you to use the shift range positions.

The “S” mode indicator light comes on when the selector lever is shifted into the “S” position. When the “S” mode indicator light does not come on even with the selector lever moved to the “S” position, there may be a problem somewhere in the system. Have your vehicle checked/repared by your Lexus dealer as soon as possible. In this case, you can drive in the same condition as in the “D” position.

- (c) **Using engine braking**



► **“S” mode position**

To use the braking power of the engine, downshift the range in the “S” mode position as follows:

- Shift into the “5” (fifth range) position. The transmission will downshift to fifth gear and engine braking will be enabled.

If you drive in the “D” position: Shift the selector lever to the “S” position and “5” (fifth range) will automatically be selected.

If you drive in the “S” position: Shift the selector lever down to the “_” position by selecting the “5” (fifth range).

Vehicles with the cruise control —

When the cruise control is being used, even if you downshift from “D” or “6” (sixth range) to “5” (fifth range), engine braking will not be enabled because the cruise control is not cancelled. For vehicle speed reduction, see page 324.

Vehicles with the dynamic radar/laser cruise control —

When the cruise control is being used in the conventional (fixed speed) cruise control mode or in the vehicle-to-vehicle distance control mode, even if you downshift from “D” or “6” (sixth range) to “5” (fifth range), engine braking will not be enabled because the cruise control is not cancelled. For vehicle speed reduction, see pages 354 and 339.

- Shift into the “4” (fourth range) position. The transmission will downshift to fourth gear when the vehicle speed is or becomes lower than 200 km/h (124 mph) and more powerful engine braking will be enabled.

If you drive in the “D” position: Shift the selector lever to the “S” position and shift the lever down to the “–” position once to select “4” (fourth range). However, when you move the lever to the “S” position while the AI shifting control is operating, the first shift range will be “5” (fifth range), “4” (fourth range) or “3” (third range) because the suitable shift range is selected depending on the driving condition.

If you drive in the “S” position: Shift the selector lever down to the “–” position to select the “4” (fourth range).

Vehicles with the cruise control —

When the cruise control is being used, even if you downshift from “D” or “5” (fifth range) to “4” (fourth range), engine braking will not be enabled because the cruise control is not cancelled. For vehicle speed reduction, see page 324.

Vehicles with the dynamic radar/laser cruise control —

When the cruise control is being used in the conventional (fixed speed) cruise control mode or in the vehicle-to-vehicle distance control mode, even if you downshift from “D” or “5” (fifth range) to “4” (fourth range), engine braking will not be enabled because the cruise control is not cancelled. For vehicle speed reduction, see pages 354 and 339.

- Shift into the “3” (third range) position. The transmission will downshift to third gear when the vehicle speed is or becomes lower than 146 km/h (91 mph) and more powerful engine braking will be enabled.

If you drive in the “D” position: Shift the selector lever to the “S” position and shift the lever down to the “–” position twice to select the “3” (third range). However, when you move the lever to the “S” position while the AI shifting control is operating, the first shift range will be “5” (fifth range), “4” (fourth range) or “3” (third range) because the suitable shift range is selected depending on the driving condition.

If you drive in the “S” position: Shift the selector lever down to the “–” position to select “3” (third range).

STARTING AND DRIVING

- Shift into the “2” (second range) position. The transmission will downshift to second gear when the vehicle speed is or becomes lower than 98 km/h (61 mph) and more powerful engine braking than that of the “3” (third range) position will be enabled.

If you drive in the “D” position: Shift the selector lever to the “S” position and shift the lever down to the “–” position three times to select “2” (second range).

If you drive in the “S” position: Shift the selector lever down to the “–” position to select “2” (second range).

- Shift into the “1” (first range) position. The transmission will downshift to first gear when the vehicle speed is or becomes lower than 38 km/h (24 mph) and maximum engine braking will be enabled.

If you drive in the “D” position: Shift the selector lever to the “S” position and shift the lever down to the “–” position four times to select “1” (first range).

If you drive in the “S” position: Shift the selector lever down to the “–” position to select “1” (first range).



CAUTION

Be careful when downshifting on a slippery surface. The abrupt change in engine speed could cause the vehicle to spin or skid.

(d) Backing up



- **1 Brake pedal** **2 “R” (Reverse) position**

1. Bring the vehicle to a complete stop.
2. With the brake pedal held down with your foot, shift the selector lever to the “R” position.

NOTICE

Never shift into reverse while the vehicle is moving.

When the selector lever is shifted into the “R” position, the outside rear view mirrors automatically down to help backing up. For details, see “Power rear view mirror control” on page 228.

Vehicles with rear view monitor system: When the selector lever is shifted into the “R” position with the ignition switch in the “ON” position, rear view monitor system will activate. For instructions, see “Rear view monitor system” on page 318.

(e) Parking



- **1** *Parking brake pedal* **2** *Brake pedal*
3 *“P” (Park) position*

1. Bring the vehicle to a complete stop.
2. Depress the parking brake pedal fully to securely apply the parking brake.
3. With the brake pedal held down with your foot, shift the selector lever to the “P” position.

! CAUTION

Never attempt to move the selector lever into “P” under any circumstances while the vehicle is moving. Serious mechanical damage and loss of vehicle control may result.

STARTING AND DRIVING

(f) Good driving practice

- If the transmission repeatedly shifts up and down between fourth and overdrive gears when climbing a gentle slope, shift the selector lever to the “4” position. Be sure to shift the selector lever to the “D” position after climbing the slope.
- When towing a trailer, in order to maintain efficient engine braking and electrical charging performance, do not use overdrive. The selector lever must be in the “4” position.



CAUTION

Always keep your foot on the brake pedal while stopped with the engine running. This prevents the vehicle from creeping.

NOTICE

Always use the brake pedal or the parking brake to hold the vehicle on an upgrade. Do not attempt to hold the vehicle using the accelerator pedal, as this can cause the transmission to overheat.

(g) If you cannot shift the selector lever

If you cannot shift the selector lever even though the brake pedal is depressed, use the shift lock override button. For instructions, see “If you cannot shift automatic transmission selector lever” on page 418.

ELECTRONIC THROTTLE CONTROL SYSTEM

The electronic throttle control system always maintains appropriate engine output in relation to the accelerator opening in all driving conditions.

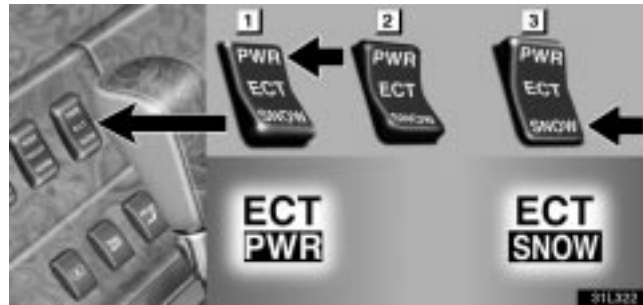

- ▶ **1** *Power position* **2** *Normal position*
- 3** *Snow position*

The electronic throttle control system has 3 modes: Normal, Power and Snow modes.

Normal mode: For ordinary driving, Lexus recommends that you use the normal mode to improve fuel economy.

Power mode: For more powerful acceleration and sporty driving.

In the power mode, the “ECT PWR” light in the instrument cluster is on and the transmission is shifted up at higher vehicle speeds and shifted down more responsively than in the normal mode.

To return to the normal mode, push the driving pattern selector switch lightly on the “SNOW” side.

Snow mode: For slippery road surfaces such as in snow. In this mode, the spinning of the rear wheels is controlled appropriately.

When you push the driving pattern selector switch on the “SNOW” side, the snow mode is turned on and the “ECT SNOW” light in the instrument cluster comes on.

To return to the normal mode, push the driving pattern selector switch on the “SNOW” side again.

When you turn the ignition switch off in the snow mode, the mode automatically changes to the normal mode.

LEXUS PARK ASSIST SYSTEM



► Sensors

The Lexus park assist system will help you to easily park by detecting any obstacle around your vehicle with ultrasonic sensors and informing you of the approximate distance from the vehicle to the obstacle with the indicators on the display and with beeping sounds.*

This system will operate at a vehicle speed of less than about 10 km/h (6 mph) with the selector lever in a position other than "P".

NOTE:

* The volume of the beeps can be changed.
Ask your Lexus dealer for details.



You can use this system in either of the following ways.

- Push the main switch of the Lexus park assist system with the ignition on. A beep sounds for one second. After the system self-check is performed, the Lexus park assist system screen appears for 2 seconds.
- Push the main switch of the Lexus park assist system and turn the ignition on. The Lexus park assist system screen appears for 2 seconds and a system self-check is performed. At this time, a beep does not sound.

If an error is detected in the Lexus park assist system while self-checking, beeps sound and the message appears in the multi-information display. For details, see "Lexus park assist system failure warning" on page 315.

Up to 4 indicator bars are shown on the front and rear sides of the vehicle mark and up to 3 indicator arcs are shown on each corner of the vehicle mark. The number of indicators shows the approximate range up to the obstacle. The indicator marks disappear one-by-one as your vehicle comes closer to the obstacle. Also, as you get closer to the obstacle, the beeping interval becomes shorter.

To turn off the system, push the main switch again.

NOTICE

- *If an accident should occur, the sensors will be affected, resulting in a system failure.*
- *If the indicators remain on the display but you do not hear a beeping sound, the system may be malfunctioning. Contact your Lexus dealer.*

Indicators and beeps

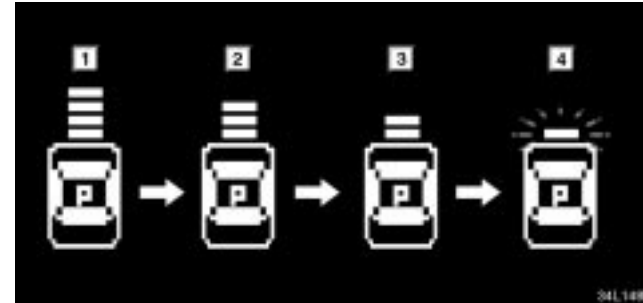

► Front or rear obstacles

Depending on the distance between your vehicle and the obstacle, the display and beeps change as follows:

- 1 About 50 cm (1.5 ft.) to about 100 cm (3.0 ft.):*** 4 bars appear on the front or rear side of the vehicle mark where the obstacle is detected. If the obstacle is detected on the rear side of the vehicle, the beeps remind you that your vehicle is getting closer to the obstacle by sounding intermittently.
- 2 About 37.5 cm (1.1 ft.) to about 50 cm (1.5 ft.):** The number of bars will decrease from 4 to 3, and the beeps sound at shorter intervals than in step **1**.
- 3 About 25 cm (0.8 ft.) to about 37.5 cm (1.1 ft.):** The number of bars will decrease from 3 to 2. The beeps sound at shorter intervals than in step **2**.

STARTING AND DRIVING

- 4** **Less than about 25 cm (0.8 ft.):** The number of bars will decrease from 2 to 1, and the bar blinks while the beeps sound continuously.

NOTE:

** The beeps can be activated or deactivated.
Ask your Lexus dealer for details.*



► **Corner obstacles**

Depending on the distance between your vehicle and the obstacle, the display and beeps change as follows:

- 1** **About 37.5 cm (1.1 ft.) to about 50 cm (1.5 ft.):** 3 arcs appear on the corner of the vehicle mark where the obstacle is detected. At this time, the beeps remind you that your vehicle is getting closer to the obstacle by sounding intermittently.
- 2** **About 25 cm (0.8 ft.) to about 37.5 cm (1.1 ft.):** The number of arcs will decrease from 3 to 2. The beeps sound at shorter intervals than in step **1**.
- 3** **Less than about 25 cm (0.8 ft.):** The number of arcs will decrease from 2 to 1, and the bar blinks while the beeps sound continuously.

Lexus park assist system failure warning

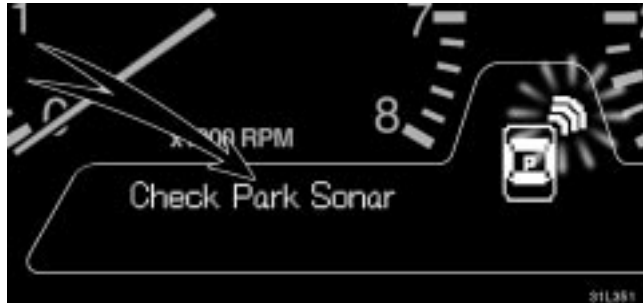

The system self check is automatically performed when the Lexus park assist system is turned on. At this time if an error is detected, the master warning light comes on accompanied by 5 beeps, the faulty sensor blinks and either of the following messages appear in the multi-information display.

- “Check Park Sonar”
- “Clean Park Sonar”

The sensors operate individually. When one sensor is malfunctioning, you will notice sounding beeps and blinking indicators to show that it is malfunctioning. If another sensor detects an obstacle during this time, the approximate distance to the obstacle will be shown by that sensor.

Check Park Sonar

If the sensor is malfunctioning or a cable is broken, the above message appears.

Although it is no problem to continue driving, have your vehicle checked by your Lexus dealer as soon as possible.

Clean Park Sonar

If icicles, snowflakes or mud gets on the sensor or it is frozen, the sensor may not be able to detect an obstacle. In either case, the above message appears.

Remove the foreign matter or deice the sensor. If the message does not appear after cleaning, the system is operating properly.

STARTING AND DRIVING

Lexus park assist system operating hints

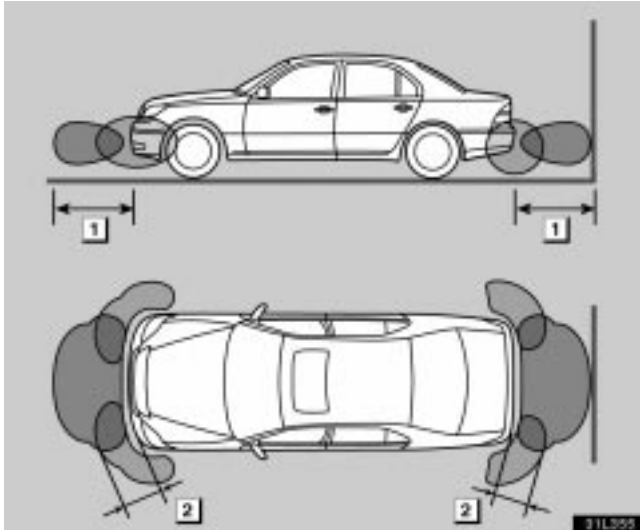

► **Sensor detection range**

1 About 1 m (3 ft.) **2** About 50 cm (1.5 ft.)

The sensor detection range is limited around the bumper. Be sure to confirm a safe distance around your vehicle and drive slowly.

If more than one obstacle is detected in the same direction, the indicators for the obstacle nearest to the vehicle will turn on.

CAUTION

Do not install an accessory or the like within the sensor detection range. Doing so may cause the Lexus park assist system to malfunction, resulting in an accident.

NOTICE

- *The sensors do not detect an obstacle just under the bumper. A short object, thin stake or the like will be detected once but might not be detected as your vehicle gets very close to such an object.*
- *If an obstacle is very close to your vehicle, it might not be detected.*
- *If a sensor is subjected to a strong impact, it will not operate properly.*

The Lexus park assist system may not work properly in the following cases:

- When icicles, snowflakes or mud gets on the sensors.
If removed, the system will work properly.
- When the sensor is frozen.
If deiced, the system will work properly.
- When the sensor is covered with something.
If removed, the system will work properly.

Especially in cold weather, a malfunction warning screen may appear on the display due to frozen sensors. If the "Clean Park Sonar" appears on the display, be sure to clean the sensor. If the "Clean Park Sonar" appears despite no mud, ice or snowflakes on the sensor, the sensor might have malfunctioned. Have your vehicle checked by your Lexus dealer.

In the following conditions, the detection range may be affected:

- When you stop your vehicle in extreme hot or cold weather.
- Foreign matter such as snowflakes or mud gets on the sensor.

The Lexus park assist system may detect the following by mistake:

- Bumpy roads or gravelled roads or grass when driving on such surfaces, or on grass
- Devices issuing ultrasonic waves, such as a horn from another vehicle, motorcycle engine, air braking sound from heavy-duty vehicles, if such a device is operated around your vehicle
- Rain or water splashing over the sensor
- The ground on which the vehicle is tilted
- Radio antenna or fender pole mounted on your vehicle
- Mud, ice or snowflakes on the sensor
- Tall curb stone
- Towing eyelet mounted on your vehicle
- Towing hitch mounted on your vehicle

STARTING AND DRIVING

The Lexus park assist system may not detect the following:

- Thin objects such as wire or rope
- Objects with a surface area too small to reflect ultrasonic waves such as wire gauze or fence
- Sound wave absorbing objects such as cotton or snow
- Objects with a sharp edge
- Shorter objects
- Tall objects with the upper part projected

For vehicles with a Navigation System, the park assist graphics appear both on the navigation display and multi-information display. For details, see the separate "Navigation System Owner's Manual".

For vehicles sold in Canada

This ISM device complies with Canadian ICES-001.

REAR VIEW MONITOR SYSTEM

The rear view monitor system assists the driver by displaying an image of the rear of the vehicle while backing up. The displayed image on the screen is a horizontally reversed mirror image of the inside rear view mirror.

To display the rear view image on the screen, place the selector lever in the "R" position when the ignition switch is in the "ON" position.

If you move the selector lever out of the "R" position, the screen returns to the previous screen. Operating another function of the navigation system will display another screen.

The rear view monitor system is a supplemental device intended to assist back up. When backing up, be sure to check behind and all around the vehicle visually.

 CAUTION

- Never depend on the rear view monitor system entirely when backing up. Always make sure your intended path is clear.

Use caution just as you would when backing up any vehicle.

- Never back up while looking only at the screen. The image on the screen is different from actual conditions. Depicted distances between objects and flat surfaces will differ from actual distances. If you back up while looking only at the screen, you may hit a vehicle, a person or an object. When backing up, be sure to check behind and all around the vehicle visually and with mirrors before proceeding.
- Do not use the system when the trunk is not completely closed.
- If the back of the vehicle is hit, the position and mounting angle of the camera may change. Be sure to have the camera's position and mounting angle checked at your Lexus dealer.
- If the temperature changes rapidly, such as when hot water is poured on the vehicle in cold weather, the system may not operate normally.

- If the camera lens becomes dirty, it cannot transmit a clear image. If water droplets, snow, or mud adhere to the lens, rinse with water and wipe with a soft cloth. If the lens is extremely dirty, wash it with a mild cleanser and rinse.
- The displayed image may become darker and moving images may be slightly distorted when the system is cold. When backing up, be sure to check behind and all around the vehicle visually and with mirror before proceeding.

STARTING AND DRIVING

AREA DISPLAYED ON SCREEN

Image is displayed approximately level on screen.

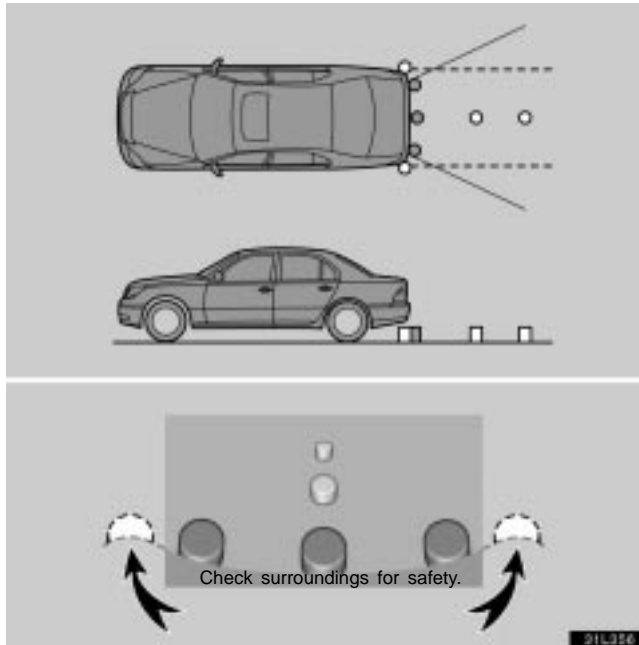

► *Corners of bumper*

- The area covered by the camera is limited. Objects which are close to either corner of the bumper or under the bumper cannot be seen on the screen.
- The area displayed on the screen may vary according to vehicle orientation or road conditions.

REAR VIEW MONITOR SYSTEM CAMERA



The rear view monitor system camera is located on the trunk as shown in the illustration. The camera uses a special lens. The distance of the image that appears on the screen differs from the actual distance.

In the following cases, it may become difficult to see the images on the screen, even when the system is functioning.

- In the dark (for example, at night)
- When the temperature near the lens is extremely high or low
- When water droplets are adhering to the camera, or when humidity is high (for example, when it rains)
- When foreign matter (for example, snow or mud) adheres to the camera lens
- When the sun or the beam of headlights is shining directly into the camera lens

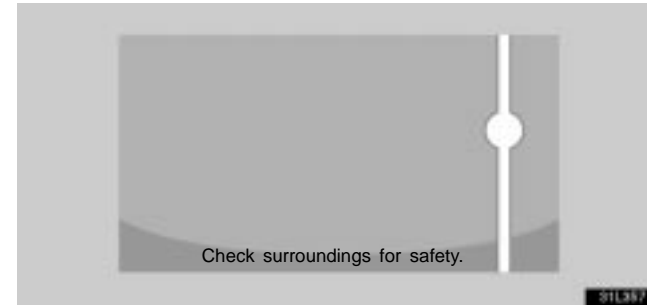

If a bright light (for example, sunlight reflected off the vehicle body) is picked up by the camera, the smear effect* peculiar to the camera may occur.

*: Smear effect — A phenomenon that occurs when a bright light (for example, sunlight reflected off the vehicle body) is picked up by the camera; when transmitted by the camera, the light source appears to have a vertical streak above and below it.

STARTING AND DRIVING

CRUISE CONTROL

The cruise control allows you to cruise the vehicle at a desired speed over about 40 km/h (25 mph) with your foot off the accelerator pedal.

Your cruising speed can be maintained although a slight speed change may occur when driving up or down a gradient, within the limits of engine performance. On steeper hills, a great speed change will occur so it is better to drive without the cruise control.

When the cruise control is on, the driving pattern of the automatic transmission is fixed in the normal position, regardless of the position of the selector switch.

CAUTION

- To help maintain maximum control of your vehicle, do not use the cruise control when driving in heavy or varying traffic, or on slippery (rainy, icy or snow-covered) or winding roads.
- Avoid vehicle speed increases when driving downhill. If the vehicle speed is too fast in relation to the cruise control set speed, cancel the cruise control then downshift the transmission to use engine braking to slow down.

Turning the system on



To operate the cruise control, push the main switch. This turns the system on. The indicator light in the instrument cluster shows that you can now set your desired cruising speed. Another push on the switch will turn the system completely off.

When the ignition switch is turned off, the main switch is also automatically turned off. To use the cruise control again, push the main switch again to turn it on.

CAUTION

To avoid accidental cruise control engagement, keep the main switch off when not using the cruise control.

Setting operation

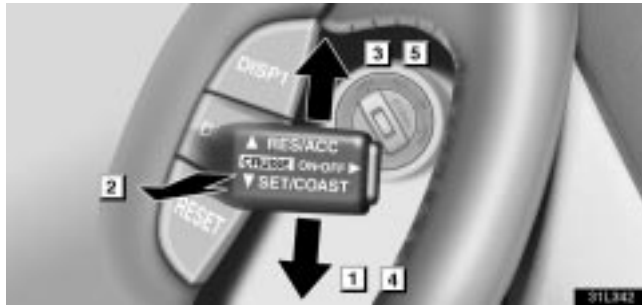

► *Each function is described below.*

1 Setting at a desired speed.

The transmission must be in the “D” position, or the shift range position must be “4” (fourth range), “5” (fifth range) or “6” (sixth range) in the “S” mode before you set the cruise control speed.

Bring the vehicle to the desired speed, press the control lever downward in the “SET/COAST” direction and release it. This sets the vehicle at that speed. Now you may take your foot off the accelerator pedal. If you need acceleration - for example, when passing - depress the accelerator pedal enough for the vehicle to exceed the set speed. When you release the accelerator pedal, the vehicle will return to the speed set prior to the acceleration.

2 Cancelling the preset speed

You can cancel the preset speed by either of the following:

- a. Pulling the control lever in the “CANCEL” direction.
- b. Depressing the brake pedal.

If the vehicle speed falls below about 40 km/h (25 mph), the preset speed will be automatically cancelled.

If the vehicle speed drops 16 km/h (10 mph) below the preset speed, the preset speed will also automatically be cancelled.

If the slip indicator light blinks and a warning tone sounds, the preset speed will be automatically cancelled.

If the preset speed automatically cancels out for other than the above reasons, do not operate the cruise control. Although it is no problem to continue driving, have your vehicle checked by your Lexus dealer at the earliest opportunity.

3 Resetting to a faster speed

Press the control lever upward in the “RES/ACC” direction and hold it. Release the lever when the desired speed is attained. While the lever is held upward, the vehicle will gradually gain speed.

When the difference between the actual vehicle speed and the set speed is less than 5 km/h (3 mph), the set speed can be increased 1.6 km/h (1 mph) each time by pressing the control lever upward in the “RES/ACC” direction quickly within 0.6 seconds.

However, a quicker way to reset is to accelerate the vehicle and then press the control lever downward in the “SET/COAST” direction.

STARTING AND DRIVING

4 Resetting to a slower speed

Press the control lever downward in the “SET/COAST” direction and hold it. Release the lever when the desired speed is attained. While the lever is held downward, the vehicle speed will gradually decrease.

When the difference between the actual vehicle speed and the set speed is less than 5 km/h (3 mph), the set speed can be lowered 1.6 km/h (1 mph) each time by pressing the control lever downward in the “SET/COAST” direction quickly within 0.6 seconds.

However, a quicker way to reset is to depress the brake pedal and then press the control lever downward in the “SET/COAST” direction.

With the cruise control on, even if you downshift the transmission from the “D” position or “6” (sixth range) to the “5” (fifth range), or from the “D” position or “5” (fifth range) to the “4” (fourth range), engine braking will not be enabled because the cruise control is not cancelled. To decrease the vehicle speed, reset to a slower speed with the cruise control lever or depress the brake pedal. If you use the brake pedal, cruise control is cancelled.

5 Resuming the preset speed

If the preset speed is cancelled by pulling the control lever, by depressing the brake pedal or vehicle stability control activation, pushing the lever up in the “RES/ACC” direction will restore the speed set prior to cancellation. However, once the vehicle speed falls below about 40 km/h (25 mph), the preset speed will not be resumed.

Cruise control failure warning

If the “CRUISE” indicator light in the instrument cluster flashes when using the cruise control, push the main switch to turn the system off and then push it again to turn it on.

If any of the following conditions then occurs, there is some trouble in the cruise control system.

- The indicator light does not come on.
- The indicator light flashes again.
- The indicator light goes out after it comes on.

If this is the case, contact your Lexus dealer and have your Lexus inspected.

DYNAMIC RADAR/LASER CRUISE CONTROL

The vehicles with pre-collision safety system are equipped with dynamic radar cruise control. For the vehicles without pre-collision safety system, dynamic laser cruise control can be equipped as optional.

Dynamic radar/laser cruise control allows you to drive at a selected cruising speed over about 45 km/h (28 mph) with your foot off the accelerator pedal, maintaining an appropriate vehicle-to-vehicle distance.

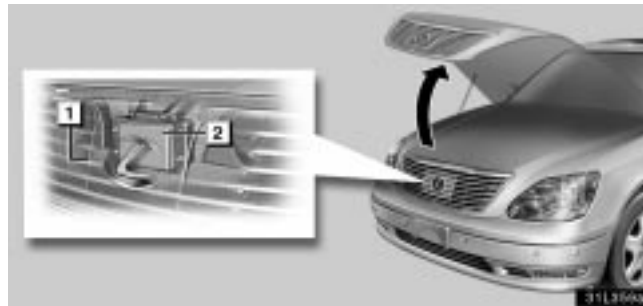

► *Dynamic radar cruise control
(Vehicles with pre-collision safety system)*

- 1 Millimeter wave grille cover
- 2 Millimeter wave radar sensor

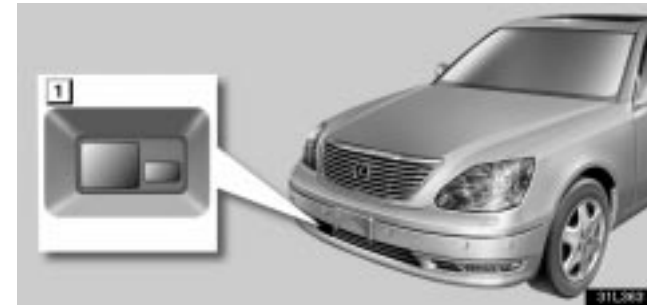

► *Dynamic laser cruise control
(Vehicles without pre-collision safety system)*

- 1 Laser radar sensor

STARTING AND DRIVING



► Inside view

- 1 Master warning light
- 2 Multi-information display
- 3 Cruise control lever
- 4 DISP2 switch (for changing vehicle-to-vehicle distance)
- 5 "CRUISE" indicator light

The dynamic radar/laser cruise control function has 2 cruise control modes: vehicle-to-vehicle distance control mode for maintaining an appropriate distance between vehicles, and a conventional (fixed speed) cruise control mode for cruising at preset speeds.

CAUTION

Always drive carefully and attentively when using either cruise control mode. Read and understand the Owner's Manual thoroughly before using the cruise control. To avoid serious injury or death, do not rely on the system to avoid accidents or to control the vehicle's speed in emergency situations. Do not use cruise control except in appropriate road and traffic conditions.

Changing the dynamic radar/laser cruise control mode

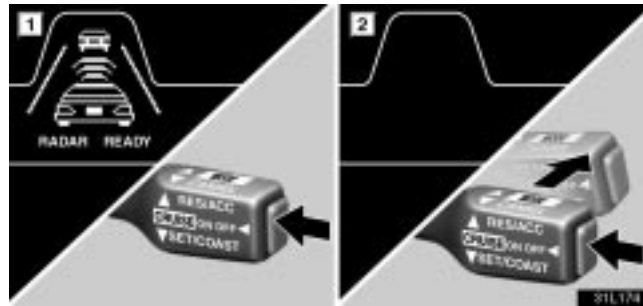

- ▶ **1** *Vehicle-to-vehicle distance control mode*
- ▶ **2** *Conventional (fixed speed) cruise control mode*

When you push the main switch, the vehicle-to-vehicle distance mode is activated. To change to the conventional (fixed speed) cruise control mode, push the lever in the "MODE" direction for longer than about 1 second.

However, once the vehicle-to-vehicle distance control mode activates and is used, it cannot be changed to the conventional (fixed speed) cruise control mode using the above operation.

To change the mode, turn the main switch off and then on. Next push the lever in the "MODE" direction for longer than about 1 second.

To change to the vehicle-to-vehicle distance control mode from the conventional (fixed speed) cruise control mode, push the lever in the "MODE" direction for longer than about 1 second.

⚠ CAUTION

In the conventional (fixed speed) cruise control mode, a warning tone does not sound to warn you if you are too close to the vehicle ahead, as neither the presence of the vehicle ahead nor the vehicle-to-vehicle distance is detected. Pay special attention to the distance between your vehicle and the vehicle ahead. Always confirm the setting in the multi-information display.

For the vehicle-to-vehicle distance control mode, see the following description. For the conventional (fixed speed) cruise control mode, see page 350.

STARTING AND DRIVING

Vehicle-to-vehicle distance control mode

Dynamic radar cruise control—

The millimeter wave radar sensor in this system primarily detects the reflected wave from the rear end of the vehicle ahead of you to determine the presence of the vehicle ahead as well as measuring the vehicle-to-vehicle distance. The detection range of the sensor is about 120 m (400 ft.) ahead.

When the dynamic radar cruise control is on, the driving pattern (power, normal) of the automatic transmission is fixed in the normal position, regardless of the position of the selector switch.



CAUTION

The dynamic radar cruise control is not a collision-avoidance system and will not prevent accidents. The dynamic radar cruise control is a vehicle speed control device that is intended for use only on freeways or roads where the traffic is light or moderate. To avoid serious injury, you must use caution and be attentive to road and traffic conditions while using dynamic radar cruise control.

Dynamic laser cruise control—

The laser radar sensor in this system primarily detects the reflectors of the vehicle ahead of you to determine the presence of the vehicle ahead as well as measuring the vehicle-to-vehicle distance. The detection range of the sensor is about 120 m (400 ft.) ahead.

When the dynamic laser cruise control is on, the driving pattern (power, normal) of the automatic transmission is fixed in the normal position, regardless of the position of the selector switch.



CAUTION

The dynamic laser cruise control is not a collision-avoidance system and will not prevent accidents. The dynamic laser cruise control is a vehicle speed control device that is intended for use only on freeways or roads where the traffic is light or moderate. To avoid serious injury, you must use caution and be attentive to road and traffic conditions while using dynamic laser cruise control.

(a) Dynamic radar/laser cruise control operations

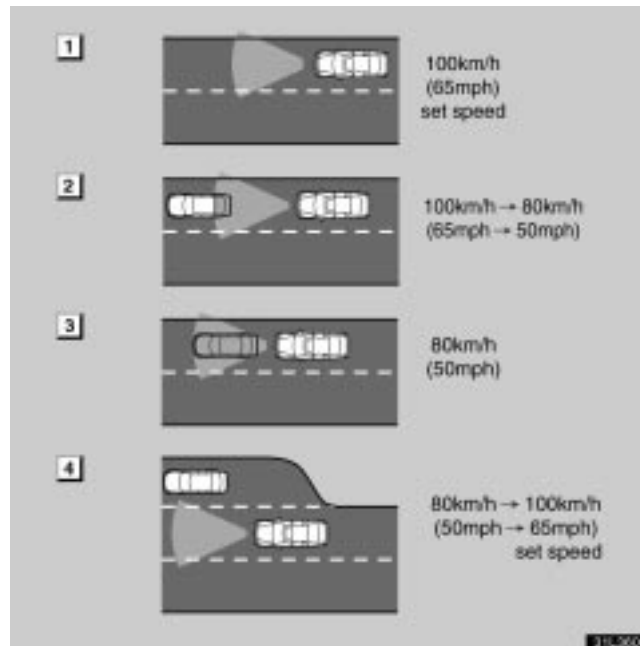

The dynamic radar/laser cruise control function operates automatically and depending on whether a vehicle is detected ahead may change the speed of your vehicle as follows:

If no vehicle is running ahead of you:

- 1 Cruising at a fixed speed:** If there is no vehicle detected ahead, your cruising speed is maintained at the preset speed from about 45 km/h (28 mph) to about 135 km/h (85 mph). The preset speed is displayed in the multi-information display. For the vehicle speed setting, see "Setting operation" on page 336.

If a vehicle is detected ahead of you:

- 2 Deceleration cruising function:** If a slower moving vehicle is detected ahead of you, your vehicle cruising speed decreases within the range of about 40 km/h (25 mph) to about 135 km/h (85 mph). The multi-information display shows the preset speed, the detected vehicle ahead and selected vehicle-to-vehicle distance. If your vehicle gets closer to the vehicle ahead because of insufficient automatic deceleration, then the warning tone warns you to also manually apply brakes.
- 3 Follow-up cruising function:** After deceleration, your vehicle cruising speed changes in proportion to the speed of the vehicle ahead to maintain an appropriate distance from your vehicle to the vehicle ahead. The vehicle-to-vehicle distance can be changed. For details, see "Changing vehicle-to-vehicle distance setting" on page 342.
- 4 Acceleration cruising function:** If the vehicle ahead changes lanes, your vehicle cruising speed will be gradually increased up to the preset speed, and your vehicle resumes fixed-speed cruising.

STARTING AND DRIVING



CAUTION

Under certain conditions where the vehicle in front slows drastically, or is stopped, the dynamic radar/laser cruise control will neither warn you nor decelerate. The driver must depress the brake pedal to slow down, ensuring collision avoidance or that sufficient vehicle-to-vehicle distance is maintained.

When vehicle-to-vehicle distance control mode is activated, you must still be attentive to road and traffic conditions. Should your vehicle speed decrease below about 40 km/h (25 mph), the dynamic radar/laser cruise control will shut off, requiring you to apply the brakes to slow. When a vehicle ahead slows suddenly, stops or a vehicle cuts in front, the system may slow your vehicle abruptly, but the automatic braking will cease if the speed decreases below about 40 km/h (25 mph) requiring the driver's manual application of brakes.

Dynamic radar cruise control—



CAUTION

Certain conditions make vehicle detection difficult or impossible.

- As this system operates by detecting primarily the reflected wave from the rear end of the vehicle ahead, the distance cannot be accurately detected in the following cases, resulting in improper vehicle-to-vehicle distance.
 - The rear section of the vehicle ahead is extremely small such as an unloaded trailer.
 - The vehicle ahead or other vehicles around you are flinging up water or snow.
 - Heavy luggage which is loaded in your trunk or on top of your rear seats is raising up the nose of your vehicle.

STARTING AND DRIVING

- The millimeter wave radar sensor automatically detects dirt if it is sticking to the front of the sensor or grille cover of your vehicle, and if detected, a message is shown on the multi-information display. However, if the sensor or grille cover is covered with a metallic vinyl bag, icicle, snowflakes, etc., dirt may not be detected, resulting in improper vehicle-to-vehicle distance. Continue driving with due care to the vehicle ahead. If dirt is detected, the dynamic radar cruise control function is automatically cancelled. Always keep the sensor and grille cover clean.

Dynamic radar cruise control should not be used in the following conditions, to avoid serious injury or death.

- In bad weather (such as rain, fog, snow, sandstorms, or when raindrops or snowflakes get in the millimeter wave radar sensor or the grille cover), the vehicle-to-vehicle distance will not be measured accurately.

If the wipers are operated at high speed (including the high speed operation with the wiper lever in the "AUTO" position), dynamic radar cruise control is automatically cancelled. (In the case of the low speed operation and intermittent wiper operation, it is not cancelled.) Dynamic radar cruise control is automatically cancelled when the measurement is extremely unstable due to bad weather.

- On the roads in heavy traffic or at sharp bends:
As an appropriate speed cannot be maintained, serious injury or death could result.
- On slippery road surfaces (icy or snow-covered road surfaces):
The tires will race and you will be unable to control.

STARTING AND DRIVING

- **On steep downhill slopes:**

If there is no vehicle detected ahead, the preset speed will be easily exceeded because of inefficient engine braking, resulting in serious injury or death. (In this case, automatic braking will not work.) If there is a vehicle detected ahead, the delay in deceleration timing could cause serious injury or death.

- When the warning tone sounds frequently (because acceleration or deceleration was repeated or sufficient vehicle-to-vehicle distance was not maintained), an appropriate vehicle speed cannot be attained, resulting in serious injury or death.
- On roads with steep and short inclines and declines, failure to detect the vehicle ahead will shorten the distance between your vehicle and the vehicle ahead, resulting in serious injury or death.

Dynamic laser cruise control—

 **CAUTION**

Certain conditions make vehicle detection difficult or impossible.

- As this system operates by detecting primarily the reflectors of the vehicle ahead, the distance cannot be accurately detected in the following cases, resulting in improper vehicle-to-vehicle distance.
 - The vehicle ahead has higher ground clearance, which means that the placement of the reflectors is in a higher position.
 - The rear section of the vehicle ahead is extremely dirty.
 - The vehicle ahead or other vehicles around you are flinging up water or snow.
 - Excessive exhaust gas (black smoke) is coming from the vehicle ahead or other vehicles around you, obscuring your front view.
 - Protective film is attached to the reflectors on the vehicle ahead, or reflectors are not installed on the vehicle ahead or are damaged.
 - Heavy luggage which is loaded in your trunk or on top of your rear seats is raising up the nose of your vehicle.

STARTING AND DRIVING

- The laser radar sensor automatically detects dirt if it is sticking to the sensor glass of your vehicle, and if detected, a message is shown on the multi-information display. However, if the sensor glass is covered with a transparent or translucent vinyl bag, icicle, etc., dirt may not be detected, resulting in improper vehicle-to-vehicle distance. Continue driving with due care to the vehicle ahead. If dirt is detected, the dynamic laser cruise control function is automatically cancelled. Always keep the sensor glass clean.

Dynamic laser cruise control should not be used in the following conditions, to avoid serious injury or death.

- In bad weather (such as rain, fog, snow, sandstorms or direct sunlight, or when raindrops or snowflakes get in the laser radar sensor glass), the vehicle-to-vehicle distance will not be measured accurately.

If the wipers are operated at high or low speeds (including the high and low speed operation with the wiper lever in the "AUTO" position), dynamic laser cruise control is automatically cancelled. (In the case of intermittent wiper operation, it is not cancelled.) Dynamic laser cruise control is automatically cancelled when the measurement is extremely unstable due to bad weather.

- On the roads in heavy traffic or at sharp bends:
As an appropriate speed cannot be maintained, serious injury or death could result.
- On slippery road surfaces (icy or snow-covered road surfaces):
The tires will race and you will be unable to control.

STARTING AND DRIVING

- **On steep downhill slopes:**

If there is no vehicle detected ahead, the preset speed will be easily exceeded because of inefficient engine braking, resulting in serious injury or death. (In this case, automatic braking will not work.) If there is a vehicle detected ahead, the delay in deceleration timing could cause serious injury or death.

- **When the warning tone sounds frequently (because acceleration or deceleration was repeated or sufficient vehicle-to-vehicle distance was not maintained), an appropriate vehicle speed cannot be attained, resulting in serious injury or death.**

- **On roads with steep and short inclines and declines, failure to detect the vehicle ahead will shorten the distance between your vehicle and the vehicle ahead, resulting in serious injury or death.**

Dynamic radar/laser cruise control—

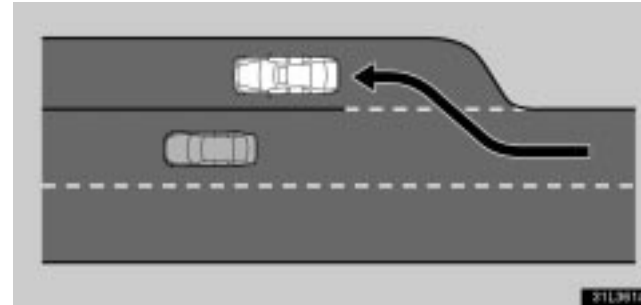

Dynamic radar/laser cruise control should not be used in circumstances which are inappropriate for any cruise control such as entering freeway on-ramps or off-ramps.

CAUTION

The dynamic radar/laser cruise control should not be used when exiting from, or when entering or merging onto a freeway. When you are following a slower moving vehicle and exiting, the sensor does not detect the vehicle and will accelerate to preset speed.

(b) Turning the system on



To operate the dynamic radar/laser cruise control, push the main switch. This turns the system on. When the “CRUISE” indicator light in the instrument cluster comes on and “RADAR READY” appears on the multi-information display, you can now set your desired cruising speed and vehicle-to-vehicle distance. Pushing the main switch again will turn the system completely off and “CRUISE OFF” will appear in the multi-information display.

When the ignition is turned off, the main switch is also automatically turned off. To use the dynamic radar/laser cruise control again, push the main switch again to turn it on.

When the ignition is turned off, all the preset data is cleared. When you use the dynamic radar/laser cruise control again, you need to reset the data.

The multi-information display will return to the vehicle-to-vehicle distance screen about 6 seconds after the vehicle-to-vehicle distance screen has been changed to another screen.

CAUTION

To avoid accidentally engaging the cruise control, keep the main switch off when not using the dynamic radar/laser cruise control.

STARTING AND DRIVING

(c) Setting operation



► **Each function is described below.**

1 Setting the desired speed

The transmission must be in "D", "6" (sixth range), "5" (fifth range) or "4" (fourth range) before you set the cruise control speed.

After bringing the vehicle to the desired speed, press the control lever downward in the "SET/COAST" direction and release it. This sets the vehicle at that speed. At this time, the multi-information display indicates settings such as the preset vehicle speed, whether a vehicle is present ahead and selected vehicle-to-vehicle distance. If there is no vehicle detected ahead, the dynamic radar/laser cruise control screen does not display the vehicle ahead. At this time, you may take your foot off the accelerator pedal. If you need to accelerate - for example, when passing - depress the accelerator pedal enough for the vehicle to exceed the preset speed. When you release the accelerator pedal, the vehicle will return to the control prior to acceleration.

You cannot set a desired speed if the master warning light comes on, the warning tone sounds and the multi-information display indicates a warning message such as "Cruise not Available", "Clean Radar Sensor" or "Check Cruise System". If any of the above messages appears on the display, see "Vehicle-to-vehicle distance control mode failure warning" on page 347.

If you turn off the main switch while the warning message is displayed, the warning message turns off and the multi-information display switches to another screen. If no warning message appears on the display, when you turn the main switch on again, the setting can be made.

You can change the dynamic radar/laser cruise control screen to another screen even while the warning message is displayed.

2 **Cancelling the preset speed**

You can cancel the preset speed by doing any of the following:

- a. Pulling the control lever toward you, in the "CANCEL" direction.
- b. Depressing the brake pedal.
- c. Pushing the main switch at the end of the cruise control lever.

If cancelled by a. or b., the multi-information display shows "RADAR READY" and the dynamic radar/laser cruise control enters the ready mode.

If cancelled by c., the "CRUISE" indicator light goes off in the instrument panel and the multi- information display shows "CRUISE OFF". In this case, the preset speed data is cleared, and you must set the speed from the beginning.

In the following cases, the preset speed automatically cancels out. At this time, the multi-information display shows "RADAR READY" and the dynamic radar/laser cruise control enters the ready mode.

- a. The vehicle speed falls below about 40 km/h (25 mph). (40 km/h (25 mph) is designated as a cancel speed.)
- b. The control lever is pressed downward in the "SET/COAST" direction and held at less than 45 km/h (28 mph). (45 km/h (28 mph) is designated as a lower preset speed limit.)



CAUTION

In either a. or b., the warning tone reminds you that the dynamic radar/laser cruise control is cancelled and you must apply the brakes to slow the vehicle.

STARTING AND DRIVING

In the following cases, the warning messages appear and the preset speed automatically cancels out. When dynamic radar/laser cruise control is restored, the warning messages turn off and dynamic radar/laser cruise control enters “RADAR READY” mode.

- a. The slip indicator light blinks and a warning tone sounds. (This occurs when the vehicle is about to skid.)
- b. The driving pattern selector switch is set to “SNOW” mode.
- c. The anti-lock brake system is activated by automatic braking. (The warning tone sounds.)
- d. The sensor does not operate properly because a foreign matter sticks to the sensor.

Dynamic radar cruise control—

- e. The wipers are operated at high speed (including high speed operation with the wiper lever in the “AUTO” position.)

Dynamic laser cruise control—

- f. The wipers are operated at high or low speeds (including high and low speed operations with the wiper lever in the “AUTO” position.)

NOTICE

If the preset speed automatically cancels out for other than the above reasons, do not operate the dynamic radar/laser cruise control. Although it is no problem to continue driving, have your vehicle checked by your Lexus dealer at the earliest opportunity.

3 Resetting to a faster speed

Press the control lever upward in the "RES/ACC" direction and hold it. The displayed speed will increase in increments of 5 mph (for U.S.A.) or 5 km/h (for Canada). Release the lever when the desired speed is attained. The vehicle will gradually increase to the displayed speed.

Depressing the accelerator pedal and pressing the control lever downward in the "SET/COAST" direction will not reset to a faster speed. At this time the set speed falls by 5 mph (for U.S.A.) or 5 km/h (for Canada).

4 Resetting to a slower speed

Press the control lever downward in the "SET/COAST" direction and hold it. The displayed speed will decrease in increments of 5 mph (for U.S.A.) or 5 km/h (for Canada). Release the lever when the desired speed is attained. The vehicle will gradually decrease to the displayed speed.

A quicker way to reset the preset speed is to depress the brake pedal and then press the control lever downward in the "SET/COAST" direction.

If the control lever is released when the vehicle speed exceeds the upper limit of the preset speed traveling downhill while you are pressing the control lever downward, the system will memorize the upper limit of the preset speed as a preset speed.

Even if you downshift the transmission from "D" or "6" (sixth range) to "5" (fifth range), or from "D" or "5" (fifth range) to "4" (fourth range) in the vehicle-to-vehicle distance control mode, engine braking will not be enabled because this mode is not cancelled. To decrease the vehicle speed, reset to a slower speed with the cruise control lever or depress the brake pedal. If you use the brake pedal, cruise control is cancelled.

STARTING AND DRIVING

5 Resuming the preset speed

If the preset speed has been cancelled, when you push the lever up in the "RES/ACC" direction while "RADAR READY" shows up on the multi-information display and at a vehicle speed of about more than 40 km/h (25 mph), the speed set prior to cancellation will be restored.

During follow-up cruising, if there are no vehicles running ahead because they have changed lanes, your vehicle will accelerate gradually up to the preset speed.

CAUTION

- Deceleration cruising function and approach warning do not operate when the vehicle ahead is at a stop or driving very slowly
- While vehicle-to-vehicle distance control (follow-up cruising) is on, acceleration and deceleration are automatically performed in proportion to the speed of the vehicle ahead detected. However, if the vehicle ahead of you decelerates abruptly or if another vehicle cuts in ahead of you, your vehicle may collide with the vehicle ahead unless you manually depress the brake pedal to slow down your vehicle. If you need to accelerate because the vehicle ahead or you changes lanes, then depress the acceleration pedal.
- Depending on the road configuration (curved roads, left and right continuous curved roads, driving at the start or end of the curve, narrow driving lanes due to road construction) or your vehicle condition (steering wheel maneuvering, position in the lane or unstable driving because of an accident or breakdown), vehicles in other lanes or surrounding objects will be detected, resulting in a control failure or the activated approach warning. This may also result in a very close distance between vehicles due to a failure to detect the vehicle ahead. Maneuvering the steering wheel in response to a violent lateral wind will cause similar conditions.

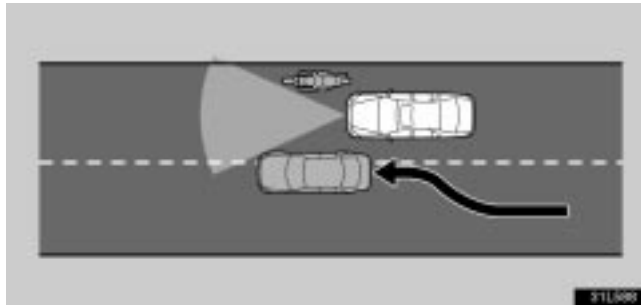

! CAUTION

If other vehicles are driving outside of the millimeter wave radar or laser radar detection range, a delay in the detection of the vehicle cutting in at short range or detection failure of the motorcycle running on the side of the same lane will occur. In this case, the dynamic radar/laser cruise control system will not function properly.

! CAUTION

- When a slower vehicle in front of you leaves the lane, the dynamic radar/laser cruise control will no longer detect a vehicle ahead and will attempt to accelerate the vehicle to the faster preset speed.
- When the vehicle-to-vehicle distance control is on (on follow-up cruising), your cruising speed is regulated in proportion to the speed of the vehicle ahead, so increasing the preset vehicle speed using the control lever does not accelerate the vehicle. However, if the vehicle ahead leaves the lane, your cruising speed will increase up to the preset speed because the preset speed has been set higher using the control lever. Confirm the setting on the multi-information display.

STARTING AND DRIVING

(d) Changing vehicle-to-vehicle distance

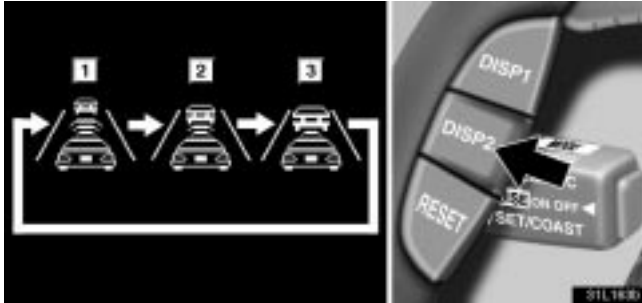

► **1** Long **2** Middle **3** Short

You can select one of the following vehicle-to-vehicle distances: “Long”, “Middle” or “Short”. Each time you push the “DISP2” switch briefly, the setting changes from “Long” to “Middle” to “Short” and then back to “Long”. You can confirm the setting on the multi-information display.

It should be noted that pushing the “DISP2” switch longer will change to another screen.

Your vehicle speed changes in proportion to the speed of the vehicle ahead, maintaining the selected distance. However, if the vehicle speed is slower, the selected distance will be shorter than the designated distance.

When the vehicle-to-vehicle distance control mode is activated or the multi-information display indicates “RADAR READY”, the vehicle-to-vehicle distance setting can be changed.

The vehicle-to-vehicle distance is always set to “Long” when the ignition switch is turned on.

CAUTION

- Select the vehicle-to-vehicle distance considering traffic conditions. The approximate vehicle-to-vehicle distance based on time interval when driving at 88 km/h (55 mph) is shown below :

“Long” about 75 m (about 245 ft.)

“Middle” about 50 m (about 165 ft.)

“Short” about 30 m (about 100 ft.)

If the vehicle speed is slower than 88 km/h (55 mph), the distance will be shorter than the above.

- During long downhill driving, the vehicle-to-vehicle distance will be shorter than the selected distance.

(e) Braking control

Dynamic radar/laser cruise control is not a collision avoidance system. If an approach warning is activated, depress the brake pedal to decelerate to ensure an appropriate vehicle-to-vehicle distance.

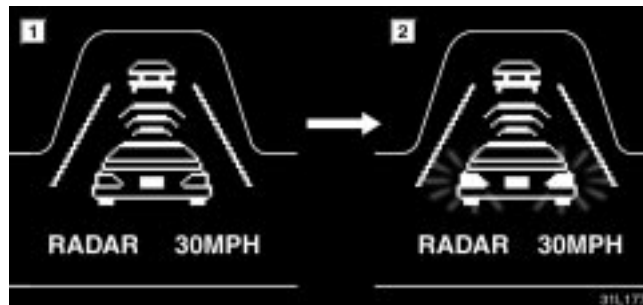

- ▶ **1 Under the vehicle-to-vehicle distance control**
- ▶ **2 Braking activated**

Braking control is operating only when the vehicle-to-vehicle distance control mode is selected and your vehicle speed exceeds about 40 km/h (25 mph).

If you are getting closer to the vehicle ahead at relatively higher speed than those of the vehicle ahead or if engine braking cannot be applied properly, braking control is automatically activated. The multi-information display changes as shown in the illustration and the stop/tail lights on your vehicle and on the vehicle on the display come on.

**CAUTION**

Braking control will not ensure that your vehicle will reduce speed appropriately. Do not rely on dynamic radar/laser cruise control to prevent collision.

STARTING AND DRIVING

(f) Approach warning



CAUTION

While you are cruising in the vehicle-to-vehicle distance control mode, if the vehicle ahead decelerates abruptly or if another vehicle cuts in ahead of you, inadequate braking will make your vehicle closer to the vehicle ahead of you and the multi-information display flashes and beeps. The driver must depress the brake pedal to slow down, ensuring collision avoidance or that sufficient vehicle-to-vehicle distance is maintained.

- The approach warning may not turn on even if the vehicle drives closer to the vehicle ahead in the following conditions:
 - Your vehicle and the vehicle ahead are cruising at almost the same speed.
 - The vehicle ahead is cruising at a faster speed than yours. (The distance between the vehicles will become longer.)
 - Pay special attention to the very slow vehicle at the end of the line in heavy traffic or at the tollgate.
 - Immediately after the speed setting
 - The accelerator pedal is depressed or immediately after the release of the accelerator pedal

**(g) Millimeter wave radar sensor
(Vehicles with dynamic radar cruise
control)**

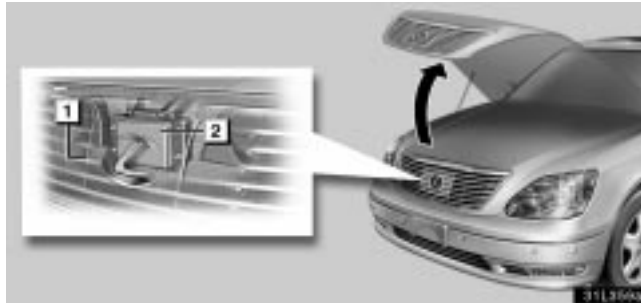

- ▶ **1** *Millimeter wave grille cover*
- ▶ **2** *Millimeter wave radar sensor*

The millimeter wave radar sensor is used for vehicle-to-vehicle distance control cruising. When the millimeter wave radar sensor is disabled for some reason, the warning message appears on the multi-information display. For details, see “Vehicle-to-vehicle distance control mode failure warning” on page 347.

For vehicles sold in U.S.A.

FCC WARNING
Changes or modifications not expressly approved by the party responsible for compliance could void the user's authority to operate the equipment.

FCC RF exposure information
This device complies with the FCC RF exposure requirements.

For vehicles sold in Canada

Operation is subject to the following two conditions;
(1) this device may not cause interference, and
(2) this device must accept any interference received, including interference that may cause undesired operation of the device.

STARTING AND DRIVING

CAUTION

To ensure that the dynamic radar cruise control system will function properly while driving, observe the following:

- Always keep the millimeter wave radar sensor and grille cover clean. When cleaning, use a soft cloth and be careful not to damage the sensor and grille cover.
- Avoid strong impacts around the millimeter wave radar sensor. An incorrect millimeter wave radar sensor alignment will result in system malfunction. A special device is required to adjust the millimeter wave radar sensor alignment. Be sure to have the sensor adjusted by your Lexus dealer.
- Do not disassemble the millimeter wave radar sensor.
- Do not affix a sticker (including a transparent sticker) or attach an accessory around the millimeter radar sensor or the grille cover.
- Do not modify or paint the grille cover. When replacing the cover, be sure to use a genuine cover.

(h) Laser radar sensor (Vehicles with dynamic laser cruise control)

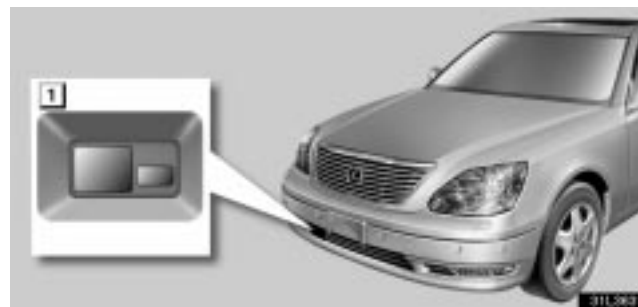

► **1** Laser radar sensor

The laser radar sensor is used for vehicle-to-vehicle distance control cruising. When the laser radar sensor is disabled for some reason, the warning message appears on the multi-information display. For details, see “Vehicle-to-vehicle distance control mode failure warning” on page 347.

This product is a class I laser product complied with 21 C.F.R part 1040.10 and 1040.11.

⚠ CAUTION

To ensure that the dynamic laser cruise control system will function properly while driving, observe the following:

- Always keep the laser radar sensor glass clean. When cleaning, use a soft cloth and be careful not to damage the sensor.
- Avoid strong impacts around the laser radar sensor. An incorrect laser radar sensor alignment will result in system malfunction. A special device is required to adjust the laser radar sensor alignment. Be sure to have the sensor adjusted by your Lexus dealer.
- Do not disassemble the laser radar sensor.
- Do not affix a sticker (including a transparent sticker) or attach an accessory around the laser radar sensor.

(i) Vehicle-to-vehicle distance control mode failure warning

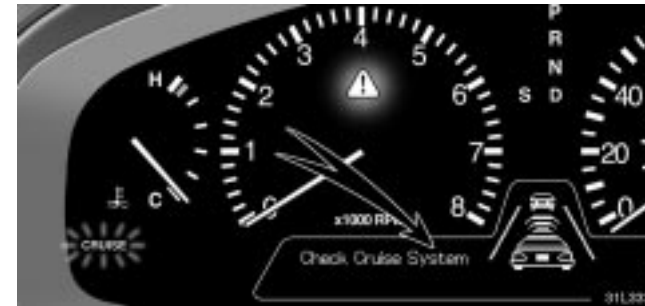

If there is trouble somewhere in the dynamic radar/laser cruise control while the vehicle-to-vehicle distance control mode is on, the "CRUISE" indicator light in the instrument cluster flashes, the master warning light comes on and the warning tone sounds, and one or more of the following warning messages will appear on the multi-information display.

- "Clean Radar Sensor"
- "Cruise not Available"
- "Check Cruise System"

If any warning message shown above appears, the preset speed automatically cancels out.

STARTING AND DRIVING

Clean Radar Sensor

Dynamic radar cruise control—

If the system cannot easily measure the vehicle-to-vehicle distance because of a dirty millimeter wave radar sensor or grille cover while the dynamic radar cruise control is on, the above message appears.

If this message appears, clean the sensor and grille cover with a soft cloth and try setting the preset speed again. If the dirt is removed without cleaning, the system will automatically enter the “RADAR READY” mode. If the system does not enter the “RADAR READY” mode even after cleaning or the message remains on the display, the system might be malfunctioning. Although it is no problem to continue driving, contact your Lexus dealer.

Dynamic laser cruise control—

If the system cannot easily measure the vehicle-to-vehicle distance because of a dirty laser radar sensor glass while the dynamic laser cruise control is on, the above message appears.

If this message appears, clean the sensor glass with a soft cloth and try setting the preset speed again. If the dirt is removed without cleaning, the system will automatically enter the “RADAR READY” mode. If the system does not enter the “RADAR READY” mode even after cleaning or the message remains on the display, the system might be malfunctioning. Although it is no problem to continue driving, contact your Lexus dealer.

Cruise not Available

If the system cannot easily measure the vehicle-to-vehicle distance because of the following conditions while the dynamic radar/laser cruise control is on, the above message appears.

Dynamic radar cruise control—

- The driving pattern selector switch is set to the “SNOW” mode.
- It is determined that it is difficult to make a measurement because of bad weather (such as extremely hot weather)
- The wipers are operated at high speed with the wiper lever in the “AUTO” position

Dynamic laser cruise control—

- The driving pattern selector switch is set to the “SNOW” mode.
- It is determined that it is difficult to make a measurement because of bad weather (such as rainy, foggy, or snowy weather)
- The wipers are operated at high or low speeds with the wiper lever in the “AUTO” position.
- Direct sunlight from the front

In the following cases, the dynamic radar/laser cruise control switches to the “RADAR READY” mode:

Dynamic radar cruise control—

- The driving pattern selector switch is changed to the “normal” or “power” position.
- The wipers are stopped or are switched to low speed or intermittent operation. (Including intermittent and stopped wipers in the “AUTO” position)

In the above conditions, press the control lever upward in the “RES/ACC” direction and release it. The dynamic radar cruise control will be restored, however, even after the weather clears, if the setting operation cannot be performed or if the warning message still appears, the system might have malfunctioned. Although it is no problem to continue driving, contact your Lexus dealer.

Dynamic laser cruise control—

- The driving pattern selector switch is changed to the “normal” or “power” position.
- The wipers are stopped or are switched to intermittent operation. (Including intermittent and stopped wipers in the “AUTO” position)
- No direct sunlight from the front

In the above conditions, press the control lever upward in the “RES/ACC” direction and release it. The dynamic laser cruise control will be restored, however, even after the weather clears, if the setting operation cannot be performed or if the warning message still appears, the system might have malfunctioned. Although it is no problem to continue driving, contact your Lexus dealer.

STARTING AND DRIVING

Check Cruise System

If a system malfunction is detected when dynamic radar/laser cruise control is in the “RADAR READY” mode or operating, the above message appears.

If this message appears, stop your vehicle in a safe place, turn the ignition off, and then restart it to reset the system. If the setting still cannot be made or the same message appears again, the system might have malfunctioned. Although it is no problem to continue driving, contact your Lexus dealer.

NOTICE

While you are cruising with the dynamic radar/laser cruise control on, if the master warning light comes on, the cruise indicator light flashes, “Check Cruise System” appears on the multi-information display and the warning tone sounds, turn the ignition switch off and then on again. If the function is cancelled again after setting or if settings cannot be made, the dynamic radar/laser cruise control system may be malfunctioning. Although it is no problem to continue driving, have your vehicle checked by your Lexus dealer.

Conventional (fixed speed) cruise control mode

This mode allows you to cruise at a desired speed over about 45 km/h (28 mph) with your foot off the accelerator pedal.

Cruising speed can be maintained, although a slight speed change may occur when driving up or down a gradient, within the limits of engine performance. On steeper hills, the speed will change more radically so it is better to drive without cruise control.

When cruise control is on, the driving pattern of the automatic transmission is fixed in the normal position, regardless of the position of the selector switch.

⚠ CAUTION

- In the conventional (fixed speed) cruise control mode, an approach warning does not activate even if you are too close to the vehicle ahead, as neither the presence of the vehicle ahead nor the vehicle-to-vehicle distance is detected. Pay special attention to the distance between your vehicle and the vehicle ahead. Always confirm the setting in the multi-information display.
- The conventional (fixed speed) cruise control mode of the dynamic radar/laser cruise control should not be used in the following conditions, which could result in serious injury or death.
 - To help maintain maximum control of your vehicle, do not use fixed speed control mode when using dynamic radar/laser cruise control while driving in heavy or varying traffic, or on slippery (rainy, icy or snow-covered) or winding roads.
 - Avoid vehicle speed increasing when driving downhill. If the vehicle speed is too fast in relation to the preset speed in the fixed speed control mode, cancel the fixed control mode and then downshift the transmission to use engine braking to slow down.

(a) Turning the system on



To operate conventional cruise control mode, push the main switch. This turns the system on. The “CRUISE” indicator light in the instrument cluster comes on and “RADAR READY” appears on the multi-information display. Push the control lever in the “MODE” direction for longer than 1 second to change to conventional cruise control mode. The indicator on the multi-information display is as shown. You can now set your desired cruising speed. Pushing the main switch again will turn the system completely off and “CRUISE OFF” will appear in the multi-information display.

However, once the vehicle-to-vehicle distance control mode activates and is used, it cannot be changed to the conventional (fixed speed) cruise control mode using the above operation.

When the ignition switch is turned off, the main switch is also automatically turned off. To use the dynamic radar/laser cruise control again, push the main switch again to turn it on.

STARTING AND DRIVING

CAUTION

To avoid accidentally engaging cruise control, keep the main switch off when not using dynamic radar/laser cruise control.

(b) Setting operation



► *Each function is described below.*

1 Setting the desired speed

The transmission must be in "D", "6" (sixth range), "5" (fifth range) or "4" (fourth range) before you set the cruise control speed in the conventional cruise control mode of the dynamic radar/laser cruise control.

After bringing the vehicle to the desired speed, press the control lever downward in the "SET/COAST" direction and release it. This sets the vehicle at that speed and the multi-information display shows the preset speed. At this time, you may take your foot off the accelerator pedal. If you need to accelerate - for example, when passing - depress the accelerator pedal enough for the vehicle to exceed the preset speed. When you release the accelerator pedal, the vehicle will return to the speed set prior to acceleration.

You cannot set a desired speed if the master warning light comes on, the warning tone sounds and the multi-information display indicates a warning message such as "Check Cruise System". If this message appears on the display, see "Conventional cruise control mode failure warning" on page 355.

If you turn off the main switch while the warning message is displayed, the warning message turns off and the multi-information display switches to another screen. When you turn the main switch on again, the warning message comes back on the display. If no warning message appears on the display, the setting can be made.

You can change the dynamic radar/laser cruise control screen to another screen even while the warning message is displayed.

2 Cancelling the preset speed

You can cancel the preset speed by doing any of the following:

- a. Pulling the control lever in the "CANCEL" direction.
- b. Depressing the brake pedal.
- c. Turning off the main switch.

If cancelled by a. or b., the multi-information display shows nothing and the conventional cruise control enters the ready mode.

If cancelled by c., the "CRUISE" indicator light goes off in the instrument panel and the multi-information display shows "CRUISE OFF". In this case, the preset speed data is cleared, and you must set the speed from the beginning.

In the following cases, the preset speed automatically cancels out:

- a. The vehicle speed falls below about 40km/h (25 mph).
- b. If the vehicle speed drops 16 km/h (10 mph) below the preset speed, the preset speed will also automatically be cancelled.
- c. The control lever is pressed downward in the "SET/COAST" direction and held at less than about 45 km/h (28 mph). (45 km/h (28 mph) is designated as a lower preset speed limit.)
- d. The slip indicator light blinks and a warning tone sounds. (This occurs when the vehicle is about to skid.)

If the vehicle speed falls below about 40 km/h (25 mph), the preset speed data is cleared and you must set the speed from the beginning.

If cancelled by the above cases, the multi-information display shows nothing and the conventional cruise control enters the ready mode.

If the preset speed automatically cancels out for other than the above reasons, do not operate the cruise control. Although it is no problem to continue driving, have your vehicle checked by your Lexus dealer at the earliest opportunity.

STARTING AND DRIVING

3 Resetting to a faster speed

Press the control lever upward in the "RES/ACC" direction and hold it. Release the lever when the desired speed is attained. While the lever is held upward, the vehicle will gradually gain speed.

When the difference between the actual vehicle speed and the set speed is less than 5 km/h (3 mph), the set speed can be increased 1.6 km/h (1 mph) each time by pressing the control lever upward in the "RES/ACC" direction quickly within 0.6 seconds.

A quicker way to reset the speed is to accelerate and then press the control lever downward in the "SET/COAST" direction.

4 Resetting to a slower speed

Press the control lever downward in the "SET/COAST" direction and hold it. Release the lever when the desired speed is attained. While the lever is held downward, the vehicle speed will gradually decrease.

When the difference between the actual vehicle speed and the set speed is less than 5 km/h (3 mph), the set speed can be lowered 1.6 km/h (1 mph) each time by pressing the control lever downward in the "SET/COAST" direction quickly within 0.6 seconds.

A quicker way to reset the preset speed is to depress the brake pedal and then press the control lever downward in the "SET/COAST" direction.

Even if you downshift the transmission from the "D" or "6" (sixth range) to "5" (fifth range), or from "D" or "5" (fifth range) to "4" (fourth range) in the conventional cruise control mode, engine braking will not be applied because this mode is not cancelled. To slow down, reset the cruise control to a slower speed with the cruise control lever or depress the brake pedal. If you use the brake pedal, cruise control is cancelled.

5 Resuming the preset speed

If the preset speed is cancelled by pulling the control lever, by depressing the brake pedal or vehicle stability control activation, pushing the lever up in the "RES/ACC" direction will restore the speed set prior to cancellation. However, once the vehicle speed falls below about 40 km/h (25 mph), the preset speed will not be resumed.

(c) Conventional cruise control mode failure warning**Check Cruise System**

If a system malfunction is detected when the conventional cruise control mode is in the ready mode or operating, the master warning light comes on, a warning tone sounds and the above message appears.

If this message appears, push the main switch to turn the system off and then push it again to turn it on. If the setting still cannot be made or the same message appears again, the system might have malfunctioned. Although it is no problem to continue driving, contact your Lexus dealer.

ELECTRONICALLY MODULATED AIR SUSPENSION

This electronically modulated air suspension adjusts the damping effect on the shock absorbers and the vehicle height. This adjustment is automatically made in response to the driving conditions to provide good riding comfort and stability in all driving conditions.

(a) Vehicle height adjustment

► **1 High position** **2 Normal position**

This system maintains a stable vehicle height, regardless of occupants and luggage weight. Select either of the following modes using a selector switch.

STARTING AND DRIVING

Normal mode: Suitable for driving on roads with a normal surface.

High mode: Suitable for driving on rough roads which are unsurfaced or continually bumpy.

The damping effect is set slightly firmer in the high mode. So you may feel the vibration of the vehicle compared to in the normal mode. However, this does not mean a malfunction in the system. We recommend you use a normal mode in normal driving.

To change the mode, push the selector switch.

Normal mode:

The vehicle height remains at normal height at all driving speeds.

High mode:

The vehicle height switches between the following two vehicle heights according to the driving conditions:

Vehicle height	Driving condition
Normal	Medium and high speed driving
High	Low speed driving



The indicator light shows the high mode is selected.

CAUTION

For vehicles equipped with the height control switch, be sure to turn the ignition switch off before jacking. If this is not done, the vehicle height adjustment function will operate, which may cause an accident.

Malfunction warning

If the system is malfunctioning, "Height Hi" appears on the multi-information display, the master warning light comes on and a warning tone sounds. Although it is no problem to continue driving, have the system checked by your Lexus dealer at the first opportunity.

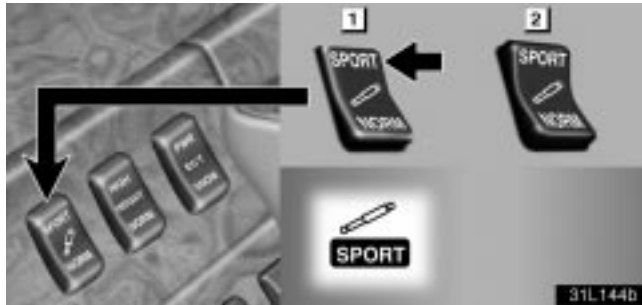
(b) Damping mode selection

► **1 Sports position** **2 Normal position**

The damping effect on the shock absorbers is adjusted. Select either of the following modes using a selector switch.

Sports mode: Suitable for sporty type driving, such as on winding mountain roads and high speed driving.

Normal mode: Suitable for ordinary driving.

To turn on the sports mode, push the selector switch on the “SPORT” side. The indicator comes on in the instrument cluster and a stronger damping effect than that in normal mode is automatically provided.

To change to the normal mode, push the switch to the “NORM” side.

TRACTION CONTROL SYSTEM

The traction control system automatically helps prevent the spinning of rear wheels when the vehicle is started or accelerated on slippery road surfaces.

When the ignition switch is turned to “ON”, the system automatically turns on.

! CAUTION

Under certain slippery road conditions, full traction of the vehicle and power against rear wheels cannot be maintained, even though the traction control system is in operation. Do not drive the vehicle under any speed or maneuvering conditions which may cause the vehicle to lose traction control. In situations where the road surface is covered with ice or snow, your vehicle should be fitted with snow tires or tire chains. Always drive at an appropriate and cautious speed for the present road conditions.

STARTING AND DRIVING



► Slip indicator light

Leave the system on during the ordinary driving so that it can operate when needed.

You may hear a sound in the engine compartment for a few seconds just after the vehicle begins to move. This means that the traction control system is in the self-check mode, but does not indicate a malfunction.

When the traction control system is operating, the following conditions occur:

- The system controls the spinning of the rear wheels. At this time, the slip indicator light blinks.
- You may feel vibration or noise in your vehicle, caused by operation of the brakes. This indicates the system is functioning properly.

The slip indicator light comes on for a few seconds when the ignition switch is turned to "ON". If the indicator light does not come on when the ignition is turned on, contact your Lexus dealer.

Traction control off mode



If your wheels get stuck in a ditch when you are driving on a severe off road and sand, turn off the traction control system. This system that controls engine performance interferes with the process of freeing your wheels.

To turn off: Push "TRAC OFF" switch.

The "TRAC OFF" indicator light will come on.

The vehicle stability control system is always activated even if the traction control system is turned off.

To turn on: Push "TRAC OFF" switch once again.

The "TRAC OFF" indicator light will go off.

“TRAC OFF” indicator light comes on for a few seconds when the ignition switch is turned to “ON”. It will come on again when you push the “TRAC OFF” switch to turn off the system.

In the following cases, contact your Lexus dealer:

- The indicator light does not come on when the ignition switch is turned to “ON”.
- The indicator light remains on after the ignition is turned on.
- The indicator light comes on in the normal driving mode while driving.

“Check VSC” warning message



If the vehicle stability control system or the traction control system malfunctions, the master warning light and “TRAC OFF” indicator light come on. At this time a warning tone sounds and the above message appears.

If the message appears, the vehicle stability control system and traction control system do not work. Although it is no problem to continue driving, have your vehicle checked by your Lexus dealer as soon as possible.

VEHICLE STABILITY CONTROL SYSTEM

The vehicle stability control system helps provide comprehensive control of the systems such as anti-lock brake system, traction control, engine control, etc. This system automatically controls the brakes and engine to help prevent the vehicle from skidding when cornering on a slippery road surface or operating steering wheel abruptly.

This system activates when the vehicle speed is about more than 15 km/h (9 mph).

You may hear a sound in the engine compartment for a few seconds just after the vehicle begins to move. This means that the system is in the self-check mode, but does not indicate a malfunction.

CAUTION

- Do not rely excessively on the vehicle stability control system. Even if the vehicle stability control system is operating, you must always drive carefully and attentively to avoid serious injury. Reckless driving will result in an accident. If the slip indicator light blinks, sounding an alarm, special care should be taken while driving.
- Only use tires of specified size. The size, manufacturer, brand and tread pattern for all 4 tires should be the same. If you use the tires other than specified, or different type or size, the vehicle stability control system may not function correctly. When replacing the tires or wheels, contact your Lexus dealer.
- In situations where the road surface is covered with ice or snow, your vehicle should be fitted with snow tires or tire chains.



► **Slip indicator light**

If the vehicle is going to skid during driving, the slip indicator light blinks and an alarm sounds intermittently. Special care should be taken while driving.

The slip indicator light comes on for a few seconds when the ignition switch is turned to “ON”. If the indicator light does not come on when the ignition is turned on, contact your Lexus dealer.

“Check VSC” warning message



If the vehicle stability control system or the traction control system malfunctions, the master warning light and “TRAC OFF” indicator light come on. At this time a warning tone sounds and the above message appears.

If the message appears, the vehicle stability control system and traction control system do not work. Although it is no problem to continue driving, have your vehicle checked by your Lexus dealer as soon as possible.

STARTING AND DRIVING

BRAKE SYSTEM

The tandem master cylinder brake system is a hydraulic system with two separate sub-systems. If either sub-system should fail, the other will still work. However, the pedal will be harder to press, and your stopping distance will increase. Also, the brake system warning light may come on.

CAUTION

Do not drive your vehicle with only a single brake system. Have your brakes fixed immediately.

Brake booster

The brake booster uses engine vacuum to power-assist the brakes. If the engine should quit while you are driving, you can bring the vehicle to a stop with normal pedal pressure. There is enough reserved vacuum for one or two stops but no more!

CAUTION

- **Do not pump the brake pedal if the engine stalls. Each push on the pedal uses up your reserved vacuum.**
- **Even if the power assist is completely lost, the brakes will still work. But you will have to push the pedal hard, much harder than normal. And your braking distance will increase.**

Anti-lock brake system

The anti-lock brake system is designed to automatically help prevent lock-up of the wheels during a sudden braking or braking on slippery road surfaces. This assists in providing directional stability and steering performance of the vehicle under these circumstances.

Effective way to press the ABS brake pedal: When the anti-lock brake system function is in action, you may feel the brake pedal pulsating and hear a noise. In this situation, to let the anti-lock brake system work for you, just hold the brake pedal down more firmly. Do not pump the brake in a panic stop. This will result in reduced braking performance.

The anti-lock brake system becomes operative after the vehicle has accelerated to a speed in excess of approximately 10 km/h (6 mph). It stops operating when the vehicle decelerates to a speed below approximately 5 km/h (3 mph).

Depressing the brake pedal on slippery road surfaces such as on a manhole cover, a steel plate at a construction site, joints in a bridge, etc. on a rainy day tends to activate the anti-lock brake system.

You may hear a click or motor sound in the engine compartment for a few seconds when the engine is started or just after the vehicle begins to move. This means that the anti-lock brake system is in the self-check mode, and does not indicate a malfunction.

When the anti-lock brake system is activated, the following conditions may occur. They do not indicate a malfunction of the system:

- You may hear the anti-lock brake system operating and feel the brake pedal pulsating and the vibrations of the vehicle body and steering wheel. You may also hear the motor sound in the engine compartment even after the vehicle is stopped.
- At the end of the anti-lock brake system activation, the brake pedal may move a little forward.

 **CAUTION**

Do not overestimate the anti-lock brake system: Although the anti-lock brake system assists in providing vehicle control, it is still important to drive with all due care and maintain a moderate speed and safe distance from the vehicle in front of you, because there are limits to the vehicle stability and effectiveness of steering wheel operation even with the anti-lock brake system on.

If tire grip performance exceeds its capability, or if hydroplaning occurs during high speed driving in the rain, the anti-lock brake system does not provide vehicle control.

Anti-lock brake system is not designed to shorten the stopping distance: Always drive at a moderate speed and maintain a safe distance from the vehicle in front of you. Compared with vehicles without an anti-lock brake system, your vehicle may require a longer stopping distance in the following cases:

- Driving on rough, gravel or snow-covered roads.
- Driving with tire chains installed.
- Driving over the steps such as the joints on the road.
- Driving on roads where the road surface is pitted or has other differences in surface height.

Install all 4 tires of specified size at appropriate pressure: The anti-lock brake system detects vehicle speeds using the speed sensors for respective wheels' turning speeds. The use of tires other than specified may fail to detect the accurate turning speed resulting in a longer stopping distance.

STARTING AND DRIVING

“ABS” warning light

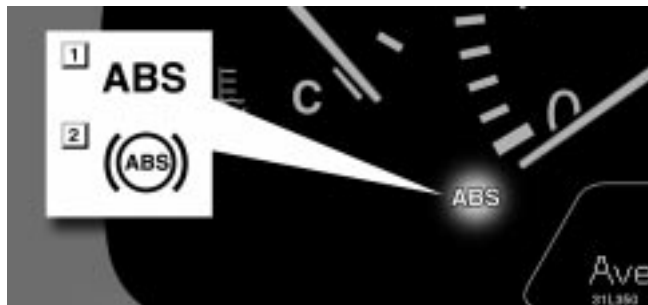

► **1 U.S.A.** **2 Canada**

The light comes on when the ignition switch is turned to the “ON” position. If the anti-lock brake system and the brake assist system work properly, the light turns off after a few seconds. Thereafter, if either of the systems malfunctions, the light comes on again.

When the “ABS” warning light is on (and the brake system warning light is off), the anti-lock brake system, the brake assist system, the traction control system and/or the vehicle stability control system do/does not operate, but the brake system still operates conventionally.

When the “ABS” warning light is on (and the brake system warning light is off), the anti-lock brake system does not operate so that the wheels could lock up during a sudden braking or braking on slippery road surfaces.

If any of the following conditions occurs, this indicates a malfunction somewhere in the components monitored by the warning light system. Contact your Lexus dealer as soon as possible to service the vehicle.

- The light does not come on when the ignition switch is turned to the “ON” position, or remains on.
- The light comes on while you are driving.

A warning light turning on briefly during operation does not indicate a problem.

CAUTION

If the “ABS” warning light remains on together with the brake system warning light, immediately stop your vehicle at a safe place and contact your Lexus dealer.

In this case, not only the anti-lock brake system will fail but also the vehicle will become extremely unstable during braking.

Drum-in-disc type parking brake system

Your vehicle has a drum-in-disc type parking brake system. This type of brake system needs bedding-down of the brake shoes periodically or whenever the parking brake shoes and/or drums are replaced.

Have your Lexus dealer perform the bedding-down.

Brake assist system

If you slam the brakes on such as in an emergency or apply the brakes more firmly than usual such as when descending the hill with the designated number of occupants in the vehicle, the brake assist system provides more powerful braking.

If you slam the brakes on or apply the brakes more firmly, more powerful braking will be applied. At this time, you may hear a sound in the engine compartment and feel the vibrations of the brake pedal. This does not indicate a malfunction.

The brake assist system becomes operative after the vehicle has accelerated to a speed in excess of approximately 10 km/h (6 mph). It stops operating when the vehicle decelerates to a speed below approximately 5 km/h (3 mph).

For an explanation of this system's warning light, see "ABS" warning light on page 86 or 364.

TIRE PRESSURE WARNING SYSTEM

The tire pressure warning system is designed to provide warning using a message in the multi-information display, master warning light and warning tone when tire inflation pressure is critically low while driving. This message appears to inform you that such low tire pressure may hamper driving.

As this system is not designed to operate when the vehicle is stopped, check the tire inflation pressure regularly. The recommended cold tire inflation pressure, tire size and the vehicle capacity weight are on the tire and loading information label. (For instructions, see "Checking tire inflation pressure" on page 476.)

Installed tires should be of the specified size. They should be of the same size and construction. If tires other than the specified size are used, or if tires of different sizes or constructions are mixed, the tire pressure warning system will not function properly.

STARTING AND DRIVING

Low tire pressure warning message

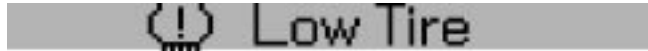

When the low tire inflation pressure is detected while driving, the master warning light comes on, the above message appears and a warning tone sounds.

If the above message appears and adjust the tire inflation pressure to the specified level as soon as possible. Push the tire pressure warning system reset switch for a few seconds and make sure of the warning message. If the message still remains on, have your vehicle checked by your Lexus dealer as soon as possible.

The tire pressure warning system does not function properly under certain circumstances. In the following cases, the low tire pressure warning may not turn on even if the tire inflation pressure is low, or it may turn on when the tire inflation pressure is actually normal.

- A compact spare tire, snow tires, or tire chains are used.
- The tire inflation pressure is excessively higher than specified, or tire inflation pressure suddenly drops due to bursting or other causes.

- You are driving on slippery road surfaces such as rough or frozen roads.
- You are driving under 30 km/h (19 mph) or above 100 km/h (62 mph) for less than 5 minutes.
- The tires differ in tread pattern or manufacturer.
- The tires are not the specified size.
- The degree of the tread wear is very different among the installed tires.
- Rapid acceleration/deceleration or sharp turns are continued.
- Towing a trailer.
- The loading is over the limit or unbalanced.
- Initialization was not performed correctly after replacing or rotating tires or wheels.
- The outside temperature is below 0°C (32°F) or above 40°C (104°F).

If the warning message appears again on the multi-information display after adjusting tire inflation pressure, the system may be malfunctioning. Have your vehicle checked by your Lexus dealer as soon as possible.

⚠ CAUTION

When the tire pressure warning message appears, observe the following instructions:

- Adjust the tire inflation pressure to the specified level as soon as possible.
- Avoid abrupt steering wheel maneuvering and braking. If the vehicle tires are deteriorated, you could lose control of the steering wheel or the brakes, causing death or serious injury.

Note:  The tire pressure warning system on your vehicle will warn you when one of your tires is significantly under-inflated and when some combinations of your tires are significantly under-inflated. However, there are other combinations of significantly under-inflated tires for which your tire pressure warning system may not warn you. These other combinations are relatively common, accounting for approximately half the instances in which vehicles have significantly under-inflated tires. For example, your system may not warn you when both tires on the same side or on the same axle of your vehicle are significantly under-inflated. It is particularly important, therefore, for you to check the tire inflation pressure in all of your tires regularly and maintain proper pressure.

Tire pressure warning system reset switch



The tire pressure warning system needs to be initialized after tires or wheels are replaced or rotated.

To initialize the system, perform the following:

1. Park the vehicle at a safe place with the parking brake applied and turn the ignition switch to “LOCK”.
2. Adjust the pressure of all the installed tires to the specified level. (See “Tires and wheels” on page 472.)
3. Turn the ignition switch to “ON”.

If the low tire pressure warning message “Low Tire” appears in the multi-information display, push the reset switch for a few seconds and make sure the warning message goes off.

4. With the vehicle stopped, push and hold the reset switch until “Pressure Initial” appears in the multi-information display.

STARTING AND DRIVING

Pressure Initial

Initialization is completed after driving at the speeds of 30 km/h (19 mph) or over for more than one hour. If the following driving conditions are satisfied, initialization will be completed in about one hour.

- The vehicle speeds is between 50 km/h (31 mph) and 100 km/h (62 mph).
- The roads are dry, smooth and straight.
- The number of passengers is one or two (including the driver).

If you make a mistake in the middle of initialization, perform the operation from the beginning again.

Do not push the reset switch without adjusting the tire inflation pressure to the specified level. Otherwise, the low tire pressure warning may not turn on even if the tire inflation pressure is low, or it may turn on when the tire inflation pressure is actually normal.

If you push the reset switch while driving, initialization is not performed.

If "Pressure Initial" does not appear when the reset switch is held down, the system may be malfunctioning. Have your vehicle checked by your Lexus dealer as soon as possible.

Tire pressure system warning message

Check System

If there is a problem electrically in the tire pressure warning system, the master warning light comes on, the above message appears and a warning tone sounds. At this time the multi-information display indicates which part causes an error.

Although it is no problem to continue driving with the above message on the display, have your vehicle checked by your Lexus dealer as soon as possible.

BRAKE PAD WEAR LIMIT INDICATORS



- ▶ **1** Master warning light
- ▶ **2** Brake pad wear warning message

When your brake pads are worn enough to require replacement, the warning tone sounds, the master warning light flashes and the brake pad wear warning message in the multi-information display appears.

If the warning message appears while driving, have the brake pads checked and replaced by your nearest Lexus dealer immediately.

Continuous driving without replacing the brake pads will cause expensive rotor damage and increasing brake pedal effort to get the same stopping distance.

PRE-COLLISION SAFETY SYSTEM (Vehicles with dynamic radar cruise control)

When the pre-collision safety system detects what it perceives to be an unavoidable collision, the front seat belts are quickly drawn back by the retractors (pre-collision seat belts) and more powerful braking is applied according to the amount of pedal depression to help reduce injury to the front seat occupants and damage to the vehicle body. In addition, the electronically modulated air suspension works to help regulate the vehicle not to pitch forward so much.

Pre-collision sensor

The millimeter wave radar sensor detects vehicles or objects near or on the road your vehicle is traveling and determines the possibility of a collision based on the object position, vehicle speeds and the course you are traveling.

The pre-collision sensor will operate in the following conditions:

- When the ignition switch is turned on.
- When the vehicle speed is about 5 km/h (3 mph) or over. (The pre-collision safety system does not work with the vehicle stopped.)

STARTING AND DRIVING

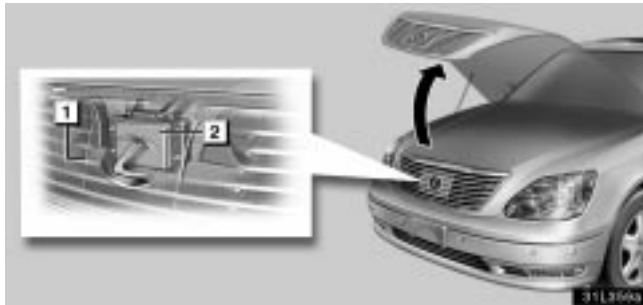

- ▶ **1** *Millimeter wave grille cover*
- 2** *Millimeter wave radar sensor*

The millimeter wave radar sensor is installed in the front grille of the hood.

The millimeter wave radar sensor cannot detect plastic objects such as pylons, and may not detect people, animals, bicycles, motor cycles, trees, snowbanks, etc. as objects with which your vehicle may collide.

CAUTION

To ensure that pre-collision safety system will function properly while driving, observe the following. Failure to follow these instructions could reduce the effectiveness of the pre-collision safety system in case of vehicle accident:

- Always keep the millimeter wave radar sensor and grille cover clean. When cleaning, use a soft cloth and be careful not to damage the sensor and grille cover.
- Avoid strong impacts around the millimeter wave radar sensor. An incorrect millimeter wave radar sensor alignment will result in system malfunction. A special device is required to adjust the millimeter wave radar sensor alignment. Be sure to have the sensor adjusted by your Lexus dealer.
- Do not disassemble the millimeter wave radar sensor.
- Do not affix a sticker (including a transparent sticker) or attach an accessory around the millimeter radar sensor or the grille cover.
- Do not modify or paint the grille cover. When replacing the cover, be sure to use a genuine cover.

Pre-collision seat belts (Front seat belts only)

When the pre-collision sensor detects an object or vehicle with which your vehicle might collide and determines that a collision may be unavoidable, the seat belts are quickly drawn back by the retractors to enhance the effects of the seat belt pretensioners. The pre-collision seat belts also work as well when hard braking.

The pre-collision seat belts will operate in the following conditions:

- When the ignition switch is turned on.
- When the vehicle speed is about 5 km/h (3 mph) or over.
- When the approaching speed in regard to the object or the vehicle exceeds about 30 km/h (18 mph).
- When the front seat occupants wear the seat belts.

Pre-collision brake assist system

When the pre-collision sensor detects an object or vehicle with which your vehicle might collide, and determines that a collision may be unavoidable, depressing the brake pedal provides more powerful braking according to the amount of pedal depression.

The pre-collision brake assist system will operate in the following conditions:

- When the ignition switch is turned on.
- When the approaching speed in regard to the object or the vehicle exceeds about 30 km/h (18 mph).
- When the brake pedal is depressed.

If the brake pedal is kept depressed before the sensor's determination of unavoidable collision, the pre-collision brake assist system will operate soon after the sensor's determination.

STARTING AND DRIVING

Electronically modulated air suspension control

When the pre-collision sensor detects an object or vehicle with which your vehicle may collide, and determines that a collision may be unavoidable, the electronically modulated air suspension adjusts the damping effect on the shock absorbers and regulates the vehicle not to pitch forward so much.

The electronically modulated air suspension will operate in the following conditions:

- When the ignition switch is turned on.
- When the vehicle speed is about 5 km/h (3 mph) or over.
- When the approaching speed in regard to the object or the vehicle exceeds about 30 km/h (18 mph).

Pre-collision safety failure warning

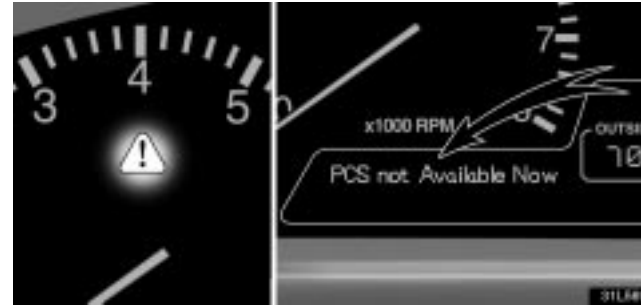

If there is a problem somewhere in the pre-collision safety system, the master warning light comes on, a warning tone sounds, and either of the following messages may appear.

PCS not Available Now

The above message appears in the following conditions:

- The millimeter wave radar sensor or the grille cover is dirty.

Clean the grille or sensor with a soft cloth to remove the dirt.

- The pre-collision seat belts are activated repeatedly for a short time.

The system turns off temporarily for overheating protection, but turns back on after a while.

Check PCS System

If there is a problem somewhere in the pre-collision safety system, the above message appears.

If the above message appears, the pre-collision safety system may not operate. Contact your Lexus dealer as soon as possible to service the vehicle.

Precaution for pre-collision safety system

It should be noted that the pre-collision sensor may detect the following as the objects with which your vehicle might collide, and the pre-collision safety may operate, even though there is no possibility of collision.

- When traveling through a curve, there is an object on the edge of the road.
- When traveling through a curve, another vehicle is passing from the opposite direction.
- When traveling across a narrow iron bridge.
- When there is a metallic object on the road.
- When there is a steel plate on the road at a construction site.
- When there is a bump on the road.
- When waiting to turn to the left in an intersection, and another vehicle is passing from the opposite direction.
- If your vehicle approaches another vehicle ahead very quickly.

STARTING AND DRIVING



CAUTION

- Do not rely solely on the pre-collision safety system to avoid accidents. Your safe and attentive driving practices are still the best way to avoid accidents and you are always responsible for the operation of the vehicle and the safety of your passengers. When driving, always pay attention to the surrounding conditions and the course you are driving.
- The pre-collision sensor's collision detection performance is limited. The sensor is able to detect a forward object within 10 degrees on either left or right side. If it is out of the range, or if there is no or weak millimeter wave reflection, the sensor could not detect the object and the system does not work properly.
- Even if the pre-collision safety is operative in an unavoidable collision, unless the seat belts are worn and the brake pedal is depressed, the pre-collision seat belts and pre-collision brake assist system will not work.

NOTICE

Even if there is no object with which your vehicle may collide, the pre-collision safety system may be activated as follows:

- *The pre-collision seat belts work to quickly draw back the front seat belts by the retractors (pre-collision seat belts).*
- *The pre-collision brake assist system works to apply more powerful braking than normal braking.*

i

SECTION 3-2

STARTING AND DRIVING

Driving tips

Break-in period	377
Operation in foreign countries	377
Tips for driving in various conditionss	377
Winter driving tips	379
Dinghy towing	380
Trailer towing	381
How to save fuel and make your vehicle last longer	387
Vehicle load limits	388
Cargo and luggage	389

BREAK-IN PERIOD

Drive gently and avoid high speeds.

You need not follow a break-in schedule with your new Lexus. But following a few simple tips for the first 1600 km (1000 miles) can add to the future economy and long life of your vehicle:

- Avoid full throttle acceleration when starting and driving.
- Avoid racing the engine.
- Try to avoid hard stops during the first 300 km (200 miles).
- Do not drive for a long time at any single speed, either fast or slow.
- Do not tow a trailer during the first 800 km (500 miles).

OPERATION IN FOREIGN COUNTRIES

If you plan to drive your Lexus in another country ...

First, comply with the vehicle registration laws.

Second, confirm the availability of the correct fuel (unleaded and minimum octane rating).

TIPS FOR DRIVING IN VARIOUS CONDITIONS

- Always slow down in gusty crosswinds. This will allow you much better control.
- Drive slowly onto curbs and, if possible, at a right angle. Avoid driving onto high, sharp-edged objects and other road hazards. Failure to do so can lead to severe tire damage such as a tire burst.
Drive slowly when passing over bumps or travelling on a bumpy road. Otherwise, the impact could cause severe damage to the tires and/or wheels.
- When parking on a hill, turn the front wheels until they touch the curb so that the vehicle will not roll. Apply the parking brake, and place the transmission in "P". If necessary, block the wheels.
- Washing your vehicle or driving through deep water may get the brakes wet. To see whether they are wet, check that there is no traffic near you and then press the pedal lightly. If you do not feel a normal braking force, the brakes are probably wet. To dry them, drive the vehicle cautiously while lightly pressing the brake pedal with the parking brake applied. If they still do not work safely, pull to the side of the road and call a Lexus dealer for assistance.

DRIVING TIPS



CAUTION

- Before driving off, make sure the parking brake is fully released and that the parking brake reminder light is off.
- Do not leave your vehicle unattended while the engine is running.
- Do not rest your foot on the brake pedal while driving. It can cause dangerous overheating, needless wear, and poor fuel economy.
- To drive down a long or steep hill, reduce your speed and downshift. Remember, if you ride the brakes excessively, they may overheat and not work properly. See page 306.
- Be careful when accelerating, upshifting, downshifting or braking on a slippery surface. The abrupt change in engine speed, such as sudden acceleration or engine braking, could cause the vehicle to spin or skid.
- Do not drive in excess of the speed limit. Even if the legal speed limit permits it, do not drive over 140 km/h (85 mph) unless your vehicle has high-speed capability tires. Driving over 140 km/h (85 mph) may result in tire failure, loss of control and possible injury. Be sure to consult a tire dealer to determine whether the tires on your vehicle are high-speed capability tires or not before driving at such speeds.

- Do not continue normal driving when the brakes are wet. If they are wet, your vehicle will require a longer stopping distance, and it may pull to one side when the brakes are applied. Also, the parking brake will not hold the vehicle securely.

WINTER DRIVING TIPS

Make sure you have a proper freeze protection for engine coolant.

Only use “Toyota Super Long Life Coolant” or similar high quality ethylene glycol based non-silicate, non-amine, non-nitrite, and non-borate coolant with long-life hybrid organic acid technology.

See “Checking the engine coolant level” on page 464 for details of coolant type selection.

“Toyota Super Long Life Coolant” is a mixture of 50% coolant and 50% deionized water. This coolant provides protection down to about -35°C (-31°F).

NOTICE

Do not use plain water alone.

Check the condition of the battery and cables.

Cold temperatures reduce the capacity of any battery, so it must be in top shape to provide enough power for winter starting. Page 505 tells you how to visually inspect the battery. Your Lexus dealer and most service stations will be pleased to check the battery charge level.

Make sure the engine oil viscosity is suitable for the cold weather.

See page 463 for recommended viscosity. Leaving a heavy summer oil in your vehicle during winter months may cause harder starting. If you are not sure about which oil to use, call your Lexus dealer - they will be pleased to help.

Check the electronic ignition system for loose connections or obvious damage.

Keep the door locks from freezing.

Squirt lock de-icer or glycerine into the locks to keep them from freezing.

Use a washer fluid containing an antifreeze solution.

This product is available at your Lexus dealer and most auto parts stores. Follow the manufacturer's directions for how much to mix with water.

NOTICE

Do not use engine antifreeze or any other substitute because it may damage your vehicle's paint.

Do not use your parking brake when there is a possibility it could freeze.

When parking, put the transmission into “P” and block the front wheels. Do not use the parking brake, or snow or water accumulated in and around the parking brake mechanism may freeze the parking brake, making it hard to release.

DRIVING TIPS

Keep ice and snow from accumulating under the fenders.

Ice and snow built up under your fenders can make steering difficult. During bad winter driving, stop and check under the fenders occasionally.

Depending on where you are driving, we recommend you carry some emergency equipment.

Some of the things you might put in the vehicle are tire chains, window scraper, bag of sand or salt, flares, small shovel, jumper cables, etc.

DINGHY TOWING

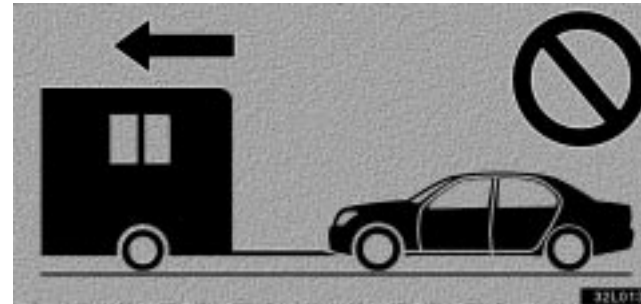

Your vehicle is not designed to be dinghy towed (with four wheels on the ground) behind a motorhome.

NOTICE

***Do not tow your vehicle with four wheels on the ground.
This may cause serious damage to your vehicle.***

TRAILER TOWING

Your vehicle is designed primarily as a passenger-carrying vehicle. Towing a trailer will have an adverse effect on handling, performance, braking, durability and driving economy (fuel consumption, etc.). Your safety and satisfaction depend on the proper use of correct equipment and cautious driving habits. For your safety and the safety of others, you must not overload your vehicle or trailer. Lexus warranties do not apply to damage or malfunction caused by towing a trailer for commercial purposes. Ask your local Lexus dealer for further details before towing.

NOTICE

When towing a trailer, be sure to consult your Lexus dealer for further information on additional requirements such as a towing kit, etc.

Weight limits

Before towing, make sure the total trailer weight, gross vehicle weight, gross axle weight and trailer tongue load are all within the limits.

The total trailer weight and tongue load can be measured with platform scales found at a highway weighing station, building supply company, trucking company, junk yard, etc.



► Certification label

⚠ CAUTION

- The total trailer weight (trailer weight plus its cargo load) must not exceed 907 kg (2000 lb.). Exceeding this weight is dangerous.

DRIVING TIPS

- Trailer hitch assemblies have different weight capacities established by the hitch manufacturer. Even though the vehicle may be physically capable of towing a higher weight, the operator must determine the maximum weight rating of the particular hitch assembly and never exceed the maximum weight rating specified for the trailer hitch. Exceeding the maximum weight rating set by the trailer hitch manufacturer can cause an accident resulting in serious personal injuries.
- The gross vehicle weight must not exceed the Gross Vehicle Weight Rating (GVWR) indicated on the Certification Label. The gross vehicle weight is the sum weight of the unloaded vehicle, driver, passengers, luggage, hitch and trailer tongue load. It also includes the weight of any special equipment installed on your vehicle.
- The load on either the front or rear axle resulting from distribution of the gross vehicle weight on both axles must not exceed the Gross Axle Weight Rating (GAWR) listed on the Certification Label.

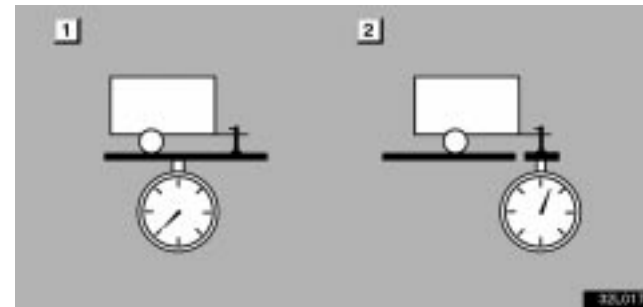

► **1** Total trailer weight **2** Tongue load

- The trailer cargo load should be distributed so that the tongue load is 9 to 11 % of the total trailer weight, not exceeding the maximum of 90 kg (200 lb.).
- Never load the trailer with more weight in the back than in the front. About 60 % of the trailer load should be in the front half of the trailer and the remaining 40 % in the rear.

Hitches

- If you wish to install a trailer hitch, your Lexus dealer should be consulted.
- Use only a hitch which is recommended by Lexus dealer and conforms to the total trailer weight requirement.
- Follow the directions supplied by the hitch manufacturer. Lubricate the hitch ball with a light coat of grease.
- Lexus recommends removing the trailer hitch whenever you are not towing a trailer to reduce the possibility of additional damage caused by the hitch if your vehicle is struck from behind. After removing the hitch, seal any mounting holes in the vehicle body to prevent entry of pollutants such as exhaust fumes, dirt, water, etc.

NOTICE

- *Install the trailer hitch using only the position recommended by your Lexus dealer. Do not install the trailer hitch on the bumper; this may cause body damage.*
- *Do not use axle-mounted hitches as they can cause damage to the axle housing, wheel bearings, wheels or tires.*

Brakes and safety chains

- Lexus recommends trailers with brakes that conform to any applicable federal and state/provincial regulations.
- A safety chain must always be used between the towing vehicle and the trailer. Leave sufficient slack in the chain for turns. The chain should cross under the trailer tongue to prevent the tongue from dropping to the ground in case it becomes damaged or separated. For correct safety chain procedures, follow the hitch or trailer manufacturer's recommendations.



CAUTION

- If the total trailer weight exceeds 450 kg (1000 lb.), trailer brakes are required.
- Never tap into your vehicle's hydraulic system as it will lower its braking effectiveness.
- Never tow a trailer without using a safety chain securely attached to both the trailer and the vehicle. If damage occurs to the coupling unit or hitch ball, there is possible danger of the trailer wandering over into another lane.

DRIVING TIPS

Tires

- Ensure that your vehicle's tires are properly inflated. Adjust the tire inflation pressure to the recommended cold tire inflation pressure indicated below:

Tire inflation pressure, kPa (kgf/cm² or bar, psi)

P225/55R17 95H Front 220 (2.2, 32)

 Rear 220 (2.2, 32)

245/45R18 96W Front 230 (2.3, 33)

 Rear 230 (2.3, 33)

- The trailer tires should be inflated to the pressure recommended by the trailer manufacturer in respect to the total trailer weight.

Trailer lights

- Trailer lights must comply with federal, state/provincial and local regulations. See your local recreational vehicle dealer or rental agency for the correct type of wiring and relays for your trailer. Check for correct operation of the turn signals and stop lights each time you hitch up. Direct splicing may damage your vehicle's electrical system and cause a malfunction of your lights.

Break-in schedule

- Lexus recommends that you do not tow a trailer with a new vehicle or a vehicle with any new power train component (engine, transmission, differential, wheel bearing, etc.) for the first 800 km (500 miles) of driving.

Maintenance

- If you tow a trailer, your vehicle will require more frequent maintenance due to the additional load. For this information, please refer to the scheduled maintenance information in the "Owner's Manual Supplement / Scheduled Maintenance".
- Retighten all fixing bolts of the towing ball and bracket after approximately 1000 km (600 miles) of trailer driving.

Pre-towing safety check

- Check that your vehicle remains level when a loaded or unloaded trailer is hitched. Do not drive if the vehicle has an abnormal nose-up or nose-down condition, and check for improper tongue load, overload, worn suspension or other possible causes.
- Make sure the trailer cargo is securely loaded so that it cannot shift.
- Check that your rear view mirrors conform to any federal, state/provincial or local regulations. If they do not, install required rear view mirrors appropriate for towing purposes.

Trailer towing tips

When towing a trailer, your vehicle will handle differently than when not towing. The three main causes of vehicle-trailer accidents are driver error, excessive speed and improper trailer loading. Keep these in mind when towing:

- Before starting out, check the operation of the lights and all vehicle-trailer connections. After driving a short distance, stop and recheck the lights and connections. Practice turning, stopping and backing with a trailer in an area away from traffic until you learn the feel.
- Backing with a trailer is difficult and requires practice. Grip the bottom of the steering wheel and move your hand to the left to move the trailer to the left. Move your hand to the right to move the trailer to the right. (This procedure is generally opposite to that when backing without a trailer.) Also, just turn the steering wheel a little at a time, avoiding sharp or prolonged turning. Have someone guide you when backing to reduce the risk of an accident.
- Because stopping distance may be increased, vehicle-to-vehicle distance should be increased when towing a trailer. For each 16 km/h (10 mph) of speed, allow at least one vehicle and trailer length between you and the vehicle ahead. Avoid sudden braking as you may skid, resulting in jackknifing and loss of control. This is especially true on wet or slippery surfaces.
- Avoid jerky starts or sudden acceleration.
- Avoid jerky steering and sharp turns. The trailer could hit your vehicle in a tight turn. Slow down before making a turn to avoid the need of sudden braking.
- Remember that when making a turn, the trailer wheels will be closer than the vehicle wheels to the inside of the turn. Therefore, compensate for this by making a larger than normal turning radius with your vehicle.
- Crosswinds and rough roads will adversely affect handling of your vehicle and trailer, causing sway. Pay attention to the rear from time to time to prepare yourself for being passed by large trucks or buses, which may cause your vehicle and trailer to sway. If swaying happens, firmly grip the steering wheel and reduce speed immediately but gradually. Never increase speed. If it is necessary to reduce speed, brake slowly. Steer straight ahead. If you make no extreme correction with the steering or brakes, your vehicle and trailer will stabilize.
- Be careful when passing other vehicles. Passing requires considerable distance. After passing a vehicle, do not forget the length of your trailer and be sure you have plenty of room before changing lanes.
- In order to maintain efficient engine braking and electrical charging performance, do not use overdrive. Transmission shift range position must be "4" (fourth range) in the "S" mode.

DRIVING TIPS

- Because of the added load of the trailer, your vehicle's engine may overheat on hot days (at temperatures over 30°C [85°F]) when going up a long or steep grade with a trailer. If the engine coolant temperature gauge indicates overheating, immediately turn off the air conditioning (if in use), pull your vehicle off the road and stop in a safe spot. See "If your vehicle overheats" on page 399.
- Always place wheel blocks under both the vehicle and trailer wheels when parking. Apply the parking brake firmly. Put the transmission in "P". Avoid parking on a slope with a trailer, but if it cannot be avoided, do so only after performing the following:
 1. Apply the brakes and keep them applied.
 2. Have someone place wheel blocks under both the vehicle and trailer wheels.
 3. When the wheel blocks are in place, release your brakes slowly until the blocks absorb the load.
 4. Apply the parking brake firmly.
 5. Shift into "P" and turn off the engine.

When restarting out after parking on a slope:

1. With the transmission in "P" position, start the engine. Be sure to keep the brake pedal depressed.
2. Shift into the "3" (third range), "2" (second range), "1" (first range) or "R" position.
3. Release the parking brake and brake pedal and slowly pull or back away from the wheel blocks. Stop and apply your brakes.
4. Have someone retrieve the blocks.

CAUTION

- **Do not exceed 72 km/h (45 mph) or the posted towing speed limit, whichever is lower. Because instability (swaying) of a towing vehicle-trailer combination usually increases as the speed increases, exceeding 72 km/h (45 mph) may cause loss of control.**
- **Slow down and downshift before descending steep or long downhill grades. Do not make sudden downshifts.**
- **Avoid holding the brake pedal down too long or too frequently. This could cause the brakes to overheat and result in reduced braking efficiency.**

HOW TO SAVE FUEL AND MAKE YOUR VEHICLE LAST LONGER

Improving fuel economy is easy - just take it easy. It will help make your vehicle last longer, too. Here are some specific tips on how to save money on both fuel and repairs:

- **Keep your tires inflated at the correct pressure.** Check the pressure every two weeks, or at least once a month. Underinflation causes tire wear and wastes fuel.
- **Do not carry unneeded weight in your vehicle.** Excess weight puts a heavier load on the engine, causing greater fuel consumption.
- **Avoid lengthy warm-up idling.** Once the engine is running smoothly, begin driving - but gently. Remember, however, that on cold winter days this may take a little longer.
- **Always keep the automatic transmission selector lever in the “D” position when engine braking is not required.** Driving with the overdrive off will reduce the fuel economy (For details, see “Automatic transmission” on page 301.)
- **Accelerate slowly and smoothly.** Avoid jackrabbit starts.
- **Avoid long engine idling.** If you have a long wait and you are not in traffic, it is better to turn off the engine and start again later.
- **Avoid engine over-revving.** Use a gear position suitable for the road on which you are traveling.
- **Avoid continuous speeding up and slowing down.** Stop-and-go driving wastes fuel.
- **Avoid unnecessary stopping and braking.** Maintain a steady pace. Try to time the traffic signals so you only need to stop as little as possible or take advantage of through streets to avoid traffic lights. Keep a proper distance from other vehicles to avoid sudden braking. This will also reduce wear on your brakes.
- **Avoid heavy traffic or traffic jams whenever possible.**
- **Do not rest your foot on the brake pedal.** This causes premature wear, overheating and poor fuel economy.
- **Maintain a moderate speed on highways.** The faster you drive, the greater the fuel consumption. By reducing your speed, you will cut down on fuel consumption.
- **Keep the front wheels in proper alignment.** Avoid hitting the curb and slow down on rough roads. Improper alignment not only causes faster tire wear but also puts an extra load on the engine, which, in turn, wastes fuel.
- **Keep the bottom of your vehicle free from mud, etc.** This not only lessens weight but also helps prevent corrosion.

DRIVING TIPS

- **Keep your vehicle tuned-up and in top shape.** A dirty air cleaner, improper valve clearance, dirty plugs, dirty oil and grease, brakes not adjusted, etc. all lower engine performance and contribute to poor fuel economy. For longer life of all parts and lower operating costs, keep all maintenance work on schedule, and if you often drive under severe conditions, see that your vehicle receives more frequent maintenance. (For scheduled maintenance information, please refer to the “Owner’s Manual Supplement / Scheduled Maintenance”.)

CAUTION

Never turn off the engine to coast down hills. Your power steering and brake booster will not function without the engine running. Also, the emission control system operates properly only when the engine is running.

VEHICLE LOAD LIMITS

Vehicle load limits include total load capacity, seating capacity, towing capacity and cargo capacity. Follow the load limits shown below.

Total load capacity: 410 kg (900 lb.)

Total load capacity means combined weight of occupants, cargo and luggage. Tongue load is included when trailer towing.

Seating capacity: Total 5 (Front 2, Rear 3)

Seating capacity means the maximum number of occupants whose estimated average weight is 68 kg (150 lb.) per person. Depending on the weight of each person, the seating capacity given may exceed the total load capacity.

NOTICE

Even if the number of occupants are within the seating capacity, do not exceed the total load capacity.

Towing capacity: 907 kg (2000 lb.)

Towing capacity means the maximum gross trailer weight (trailer weight plus its cargo weight) that your vehicle is able to tow.

Cargo capacity

Cargo capacity may increase or decrease depending on the size (weight) and the number of occupants. For details, see “Capacity and distribution” that follows.

 **CAUTION**

Do not apply the load more than each load limit. That may cause not only damage to the tires, but also deterioration to the steering ability and braking ability, which may cause an accident.

CARGO AND LUGGAGE**Stowage precautions**

When stowing cargo and luggage in the vehicle, observe the following:

- Put cargo and luggage in the trunk when at all possible. Be sure all items are secured in place.
- Be careful to keep the vehicle level. Placing the weight as far forward as possible helps maintain vehicle balance.
- For better fuel economy, do not carry unnecessary weight.

 **CAUTION**

- **Do not place anything on the package tray behind the rear seatback. Such items may be thrown about and possibly injure people in the vehicle during sudden braking or in an accident.**
- **Do not drive with objects left on top of the instrument panel. They may interfere with the driver’s field of view. Or they may move during sharp vehicle acceleration or turning, and impair the driver’s control of the vehicle. In an accident they may injure the vehicle occupants.**

DRIVING TIPS

NOTICE

Do not load the vehicle beyond the vehicle capacity weight specified on the tire and loading information label affixed on the center pillar on the driver side.

Capacity and distribution

Cargo capacity depends on the total weight of the occupants.

(Cargo capacity) = (Total load capacity) – (Total weight of occupants)

Steps for determining correct load limit

1. Locate the statement “The combined weight of occupants and cargo should never exceed XXX pounds” on your vehicle’s placard.
2. Determine the combined weight of the driver and passengers that will be riding in your vehicle.
3. Subtract the combined weight of the driver and passengers from XXX kilograms or XXX pounds.
4. The resulting figure equals the available amount of cargo and luggage load capacity. For example, if the “XXX” amount equals 1400 lbs. and there will be five 150 lb. passengers in your vehicle, the amount of available cargo and luggage load capacity is 650 lbs. $1400 - 750 (5 \times 150) = 650$ lbs.
5. Determine the combined weight of luggage and cargo being loaded on the vehicle. That weight may not safely exceed the available cargo and luggage load capacity calculated in Step 4.

6. If your vehicle will be towing a trailer, load from your trailer will be transferred to your vehicle. Consult this manual to determine how this reduces the available cargo and luggage load capacity of your vehicle.

For details about trailer towing, see page 381.

Example on your vehicle

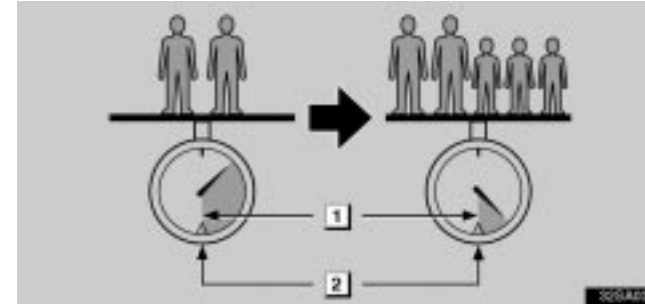

► **1** *Cargo capacity* **2** *Total load capacity*

In case that 2 people with the combined weight of 166 kg (366 lb.) are riding in your vehicle with the total load capacity of 410 kg (900 lb.), the available amount of cargo and luggage load capacity will be as follows:

$$410 \text{ kg} - 166 \text{ kg} = 244 \text{ kg.}$$

$$(900 \text{ lb.} - 366 \text{ lb.} = 534 \text{ lb.})$$

From this condition, if 3 more passengers with the combined weight of 176 kg (388 lb.) get on, the available cargo and luggage load will be reduced as follows:

$$244 \text{ kg} - 176 \text{ kg} = 68 \text{ kg.}$$

$$(534 \text{ lb.} - 388 \text{ lb.} = 146 \text{ lb.})$$

DRIVING TIPS

As shown in the above example, if the number of occupants increases, the cargo and luggage load equaling the combined weight of occupants who got on later must be reduced. In other words, if the increase in the number of occupants causes the excess of the total load capacity (combined weight of occupants plus cargo and luggage load), you have to reduce the cargo and luggage on your vehicle.

For details about total load capacity, see “Vehicle load limits” on page 388.



CAUTION

Even if the total load of occupant's weight and the cargo load is less than the total load capacity, do not apply the load unevenly. That may cause not only damage to the tire but also deterioration to the steering ability due to unbalance of the vehicle, causing an accident.

1

SECTION 4

IN CASE OF AN EMERGENCY

In case of an emergency

If your engine stalls while driving	395
If your vehicle will not start	395
If you cannot increase engine speed	399
If your vehicle overheats	399
If you have a flat tire	400
If your vehicle becomes stuck	410
If your vehicle needs to be towed	411
If you cannot shift automatic transmission selector lever	418
Lexus link system	419
If you lose your keys or lock yourself out	432

IF YOUR ENGINE STALLS WHILE DRIVING

If your engine stalls while driving . . .

1. Reduce your speed gradually, keeping a straight line. Move cautiously off the road to a safe place.
2. Turn on your emergency flashers.
3. Turn the ignition switch to "ACC" or "LOCK", and try starting the engine again.

If the engine will not start, see "If your vehicle will not start".

 **CAUTION**

If the engine is not running, the power assist for the brakes and steering will not work, so steering and braking will be much harder than usual.

IF YOUR VEHICLE WILL NOT START

(a) Simple checks

Before making these checks, make sure you have followed the correct starting procedure instructions in "How to start the engine" on page 300 and that you have sufficient fuel. Since your vehicle is equipped with the engine immobilizer system, also check whether the other keys will start the engine. If they work, your key may be broken. Have the key checked at your Lexus dealer. If none of your keys work, there may be a malfunction in the immobilizer system. Call your Lexus dealer. See "Keys" on page 10.

If the engine is not turning over or is turning over too slowly -

1. Check that the battery terminals are tight and clean.
2. If the battery terminals are O.K., switch on the interior light.
3. If the light is out, dim or goes out when the starter is cranked, the battery is discharged. You may try jump starting. See "(c) Jump starting" for further instruction.

If the light is O.K., but the engine still will not start, it needs adjustment or repair. Call a Lexus dealer, Roadside Assistance or Customer Service Assistance. (See "Foreword".)

IN CASE OF AN EMERGENCY

NOTICE

Do not pull- or push-start the vehicle. It may damage the vehicle or cause a collision when the engine starts. Also the three-way catalytic converter may overheat and become a fire hazard.

If the engine turns over at its normal speed but will not start -

1. If the engine will not start, the engine may be flooded because of repeated cranking. See “(b) Starting a flooded engine” for further instructions.
2. If the engine still will not start, it needs adjustment or repair. Call a Lexus dealer, Roadside Assistance or Customer Service Assistance. (See “Foreword”.)

(b) Starting a flooded engine

If the engine will not start, your engine may be flooded because of repeated cranking.

If this happens, turn the ignition switch to “START” with the accelerator pedal fully depressed. Continue this operation for 30 seconds and then stop cranking. Then try starting the engine with your foot off the accelerator pedal.

If the engine does not start after 30 seconds of cranking, release the ignition switch, wait a few minutes and try again.

If the engine still will not start, it needs adjustment or repair. Call a Lexus dealer, Roadside Assistance or Customer Service Assistance. (See “Foreword”.)

NOTICE

Do not crank for more than 30 seconds at a time. This may overheat the starter and wiring systems.

(c) Jump starting

To avoid serious personal injury and damage to your vehicle which might result from battery explosion, acid burns, electrical burns, or damaged electronic components, these instructions must be followed precisely.

If you are unsure about how to follow this procedure, we strongly recommend that you seek help from your Lexus dealer, Roadside Assistance or Customer Service Assistance. (See “Foreword”.)

⚠ CAUTION

- Batteries contain sulfuric acid which is poisonous and corrosive. Wear protective safety glasses when jump starting, and avoid spilling acid on your skin, clothing, or vehicle.
- If you should accidentally get acid on yourself or in your eyes, remove any contaminated clothing and flush the affected area with water immediately. Then get immediate medical attention. If possible, continue to apply water with a sponge or cloth while en route to the medical office.
- The gas normally produced by a battery will explode if a flame or spark is brought near. Use only standardized jumper cables and do not smoke or light a match while jump starting.

NOTICE

The battery used for boosting must be 12 V. Do not jump start unless you are sure that the booster battery is correct.

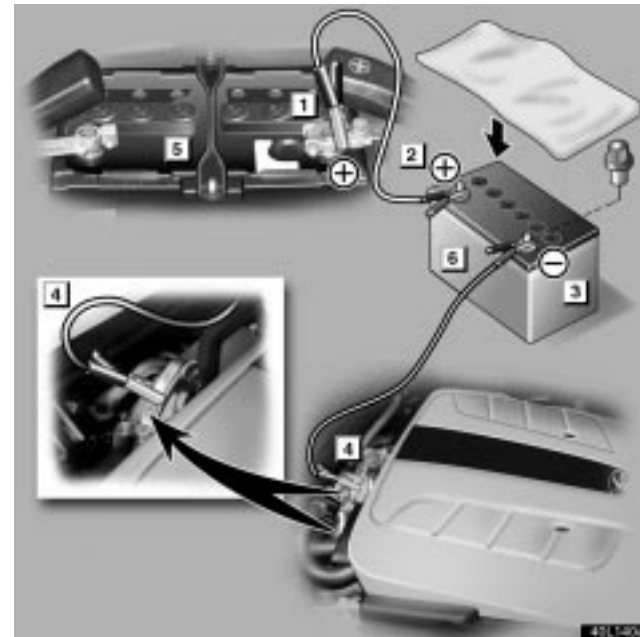

► **5** Discharged battery **6** Booster battery

JUMP STARTING PROCEDURE

1. If the booster battery is installed in another vehicle, make sure the vehicles are not touching. Turn off all unnecessary lights and accessories.

IN CASE OF AN EMERGENCY

2. If required, remove all the vent plugs from the booster battery. Lay a cloth over the open vents on the booster battery. (This helps reduce the explosion hazard, personal injuries and burns.)

If the booster battery is an extended maintenance interval battery, it is not necessary to remove the vent plugs.

3. If the engine in the vehicle with the booster battery is not running, start it and let it run for about 5 minutes. During jump starting, run the engine at about 2000 rpm with the accelerator pedal lightly depressed.

4. Locate positive (+) and negative (-) terminals of each battery. Connect the jumper cables in the exact order (**1** **2** **3** **4**) shown in the illustration.

- 1** Connect a positive (red) jumper cable clamp to the positive (+) terminal of the discharged battery.
- 2** Connect the clamp at the other end of the positive (red) cable to the positive (+) terminal of the booster battery.
- 3** Connect a negative (black) cable clamp to the negative (-) terminal of the booster battery.
- 4** Connect the clamp at the other end of the negative (black) cable to a solid, stationary, unpainted metallic point (such as shown in the illustration) away from the battery. Do not connect it to or near any part that moves when the engine is cranked.

CAUTION

When making the connections, to avoid serious injury, do not lean over the battery or accidentally let the jumper cables or clamps touch anything except the correct battery terminals or the ground.

5. Start your engine in the normal way. After starting, run it at about 2000 rpm for several minutes with the accelerator pedal lightly depressed.

6. Carefully disconnect the cables in the exact reverse order: the negative cable and then the positive cable.

7. Carefully dispose of the battery cover cloths which may now contain sulfuric acid.

8. If removed, replace all the battery vent plugs.

If the cause of your battery discharging is not apparent (for example, lights left on), you should have it checked at your Lexus dealer.

IF YOU CANNOT INCREASE ENGINE SPEED

If engine speed does not increase when the accelerator pedal is depressed, the electronic throttle control system may be faulty. Move the vehicle to a safe place by means of creeping and call a Lexus dealer for assistance:

1. Depress the brake pedal and shift to the "D" position.
2. Gradually release the brake pedal, and the vehicle starts to move by creeping. After arriving at a safe place, stop the vehicle and call a Lexus dealer for assistance.

CAUTION

- The above method of moving the vehicle is for emergency. Use it only for moving minimum distances to a safe place.
- Be especially careful to prevent erroneous pedal operation.

IF YOUR VEHICLE OVERHEATS

If your engine coolant temperature gauge indicates overheating, if you experience a loss of power, or if you hear a loud knocking or pinging noise, the engine has probably overheated.

When the engine overheats

Pull safely off the road, stop the vehicle and turn on your emergency flashers. Put the transmission in "P" and apply the parking brake.

A: If steam is coming from your engine:

Turn off the engine. Leave the hood closed until there is no sign of steam or coolant. Your engine could have been seriously damaged already. Call your Lexus dealer for assistance.

CAUTION

To help avoid personal injury, keep the hood closed until there is no steam. Escaping steam or coolant is sign of very high pressure.

IN CASE OF AN EMERGENCY

B: If no steam is coming from your engine:

Leave the engine running and turn off the air conditioning. Check the following.

- Is the cooling fan operating?
- Is the coolant in the acceptable range?
- Is the engine drive belt O.K.?

 CAUTION
<ul style="list-style-type: none">• When the engine is running, keep hands and clothing away from the moving fan and engine drive belt.• Do not attempt to remove the radiator cap when the engine and radiator are hot. Serious injury could result from scalding hot fluid and steam blown out under pressure.

If the cooling fan is not operating or the coolant is not in the acceptable range, turn off the engine and call your Lexus dealer.

If both conditions are O.K., after the engine coolant temperature has cooled to normal, continue driving your vehicle.

If the engine coolant temperature does not cool down, or your vehicle overheats again, have it checked as soon as possible by your Lexus dealer.

IF YOU HAVE A FLAT TIRE

1. Reduce your speed gradually, keeping a straight line. Move cautiously off the road to a safe place - well away from the traffic. Avoid stopping on the center divider of a highway. Park on a level spot with firm ground.
2. Stop the engine and turn on your emergency flashers.
3. Firmly set the parking brake and put the transmission in "P".
4. Have everyone get out of the vehicle on the side away from traffic.
5. Read the following instructions thoroughly.

 CAUTION
<p>When jacking, be sure to observe the following to reduce the possibility of personal injury:</p> <ul style="list-style-type: none">• Follow jacking instructions.• Do not put any part of your body under a vehicle supported by a jack. Otherwise, personal injury may occur.• Do not start or run the engine while your vehicle is supported by the jack.

IN CASE OF AN EMERGENCY

- Stop the vehicle on a level firm ground, firmly set the parking brake and put the transmission in “P”. Block the wheel diagonally opposite to the one being changed if necessary.
- Make sure to set the jack properly in the jack point. Raising the vehicle with jack improperly positioned will damage the vehicle or may allow the vehicle to fall off the jack and cause personal injury.
- Never get under the vehicle when the vehicle is supported by the jack alone.
- Use the jack only for lifting your vehicle during wheel changing.
- Do not raise the vehicle with someone in the vehicle.
- When raising the vehicle, do not put an object on or under the jack.
- Raise the vehicle only high enough to remove and change the tire.
- For vehicles equipped with the height control switch, be sure to turn the ignition switch off before jacking. If this is not done, the vehicle height adjustment function will operate, which may cause an accident.

NOTICE

Do not continue driving with a deflated tire. Driving even a short distance can damage a tire and wheel beyond repair.

IN CASE OF AN EMERGENCY

Access to spare tire

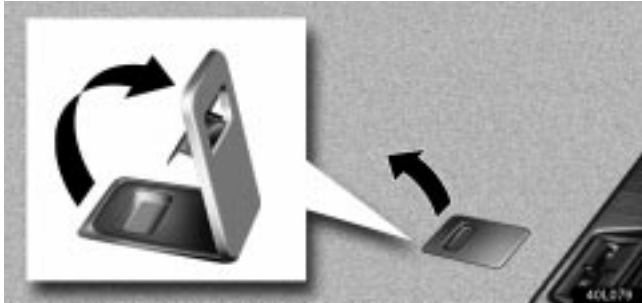

1. Pull up the deck board.



2. Lift up the back side of the board and secure the board by hooking the lever at the top of the trunk lid opening as shown.

Make sure the board is secured and does not fall down.

IN CASE OF AN EMERGENCY

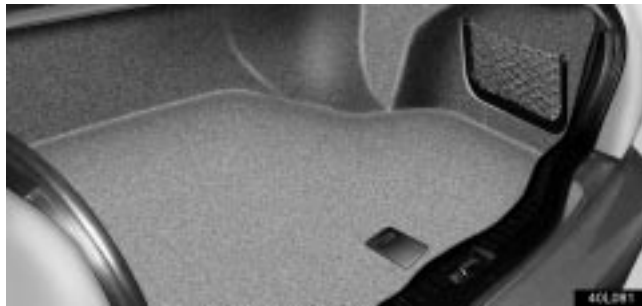

When closing the board, replace the hook also in its original position as shown.

NOTICE

If you close the trunk lid with the board hooked, the hook may be damaged.



- ▶ **1** Tool box
- 2** Towing eyelet (For emergency towing)
- 3** Jack handle **4** Spare tire **5** Jack

1. Get the tool, jack and spare tire.

To prepare yourself for an emergency, you should familiarize yourself with the use of the jack and each tool, and their storage locations.

IN CASE OF AN EMERGENCY

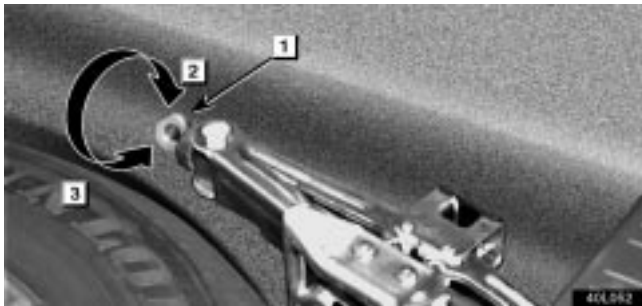

► **1 Joint**

- 2** When removing the jack, turn the joint by hand in the “contract” direction until the jack is free.
- 3** When storing, turn the joint by hand in the “expand” direction until the jack is firmly secured to prevent it from flying forward during a collision or sudden braking.



To remove the spare tire:

- 1** Remove the spare tire cover.
- 2** Loosen the bolt and remove it.

When storing the spare tire, place it with the inner side of the wheel facing up. Then bolt the tire in place and install the spare tire cover to prevent the tire from flying forward during a collision or sudden braking.

IN CASE OF AN EMERGENCY



2. Block the wheel diagonally opposite the flat tire to keep the vehicle from rolling when it is jacked up.

When blocking a wheel, place a wheel block in front of one of the front wheels or behind one of the rear wheels.



3. Loosen all the wheel nuts.

Always loosen the wheel nuts before raising the vehicle.

Turn the wheel nuts counterclockwise to loosen them. To get maximum leverage, fit the wrench to the nut so that the handle is on the right side, as shown above. Grab the wrench near the end of the handle and pull up on the handle. Be careful that the wrench does not slip off the nut.

Do not remove the nuts yet - just unscrew them about one-half turn.

⚠ CAUTION

Never use oil or grease on the bolts or nuts. The nuts may loosen and the wheels may fall off, which could cause a serious accident.

IN CASE OF AN EMERGENCY

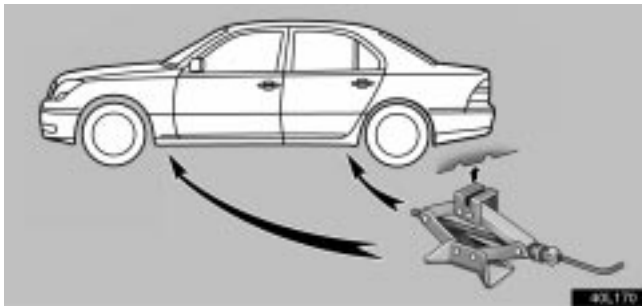

4. Position the jack at the jack points as shown.

Make sure the jack is positioned on a level and solid surface.



5. After making sure no one is in the vehicle, raise it high enough so that the spare tire can be installed.

Allow for the fact that you need more ground clearance when putting on the spare tire than when removing the flat tire.

To raise the vehicle, insert the jack handle into the jack (it is a loose fit) and turn it clockwise. As the jack touches the vehicle and begins to lift, double-check that it is properly positioned.

CAUTION

Never get under the vehicle when the vehicle is supported by the jack alone.

IN CASE OF AN EMERGENCY



6. Remove the wheel nuts and remove the flat tire.

Lift the flat tire straight off and put it aside.



7. Remove the wheel ornament.

When installing the alloy wheels, remove the wheel ornament from the flat tire and replace it on the newly installed tire.

IN CASE OF AN EMERGENCY

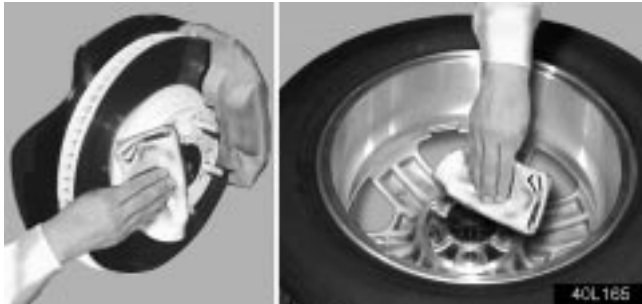

Before putting on the wheel, remove any corrosion on the mounting surfaces with a wire brush or such. Installation of wheels without good metal-to-metal contact at the mounting surface can cause wheel nuts to loosen and eventually cause a wheel to come off while driving.



8. Reinstall all the wheel nuts finger tight.

Align the holes in the wheel with the bolts. Then lift up the wheel and get at least the top bolt started through its hole. Wiggle the tire and press it back over the other bolts.

Reinstall the wheel nuts and tighten them as much as you can by hand. Press the tire back and see if you can tighten them more.

CAUTION

Never use oil or grease on the bolts or nuts. Doing so may lead to overtightening the nuts and damaging the bolts. The nuts may loosen and the wheels may fall off, which could cause a serious accident. If there is oil or grease on any bolt or nut, clean it.



9. Lower the vehicle completely and tighten the wheel nuts.

Turn the jack handle counterclockwise to lower the vehicle.

Use only the wheel nut wrench to tighten the nuts. Do not use other tools or any additional leverage other than your hands, such as a hammer, pipe or your foot. Make sure the wrench is securely engaged over the nut.

Tighten each nut a little at a time in the order shown. Repeat the process until all the nuts are tight.

! CAUTION

- When lowering the vehicle, make sure all portions of your body and all other persons around will not be injured as the vehicle is lowered to the ground.

- Have the wheel nuts tightened with torque wrench to 103 N-m (10.5 kgf-m, 76 ft-lbf.), as soon as possible after changing wheels. Otherwise, the nuts may loosen and the wheels may fall off, which could cause a serious accident.

10. After changing the wheel, check the air pressure of the replaced tire. Stow all the tools, jack and flat tire securely.

If the pressure of the replaced tire is low, drive slowly to the nearest service station and fill to the correct pressure.

Do not forget to reinstall the tire valve cap as dirt and moisture could get into the valve core and possibly cause air leakage. If the cap is missing, put a new one on as soon as possible.

This is the same procedure for changing or rotating your tires.

IN CASE OF AN EMERGENCY



CAUTION

- Before driving, make sure all the tools, jack and flat tire are securely in place in their storage location to reduce the possibility of personal injury during a collision or sudden braking.
- When reinstalling a standard tire, take due care in handling the ornament to avoid unexpected personal injury.

IF YOUR VEHICLE BECOMES STUCK

If your vehicle becomes stuck in snow, mud, sand, etc., then you may attempt to rock the vehicle free by moving it forward and backward.

Turn off the traction control system to become unstuck to allow the tires to spin enough to remove the vehicle from the obstruction. (For details, see “Vehicle stability control system” on page 360.)



CAUTION

Do not attempt to rock the vehicle free by moving it forward and backward if people or objects are anywhere near the vehicle. During the rocking operation the vehicle may suddenly move forward or backward as it becomes unstuck, causing injury or damage to nearby people or objects.

NOTICE

If you rock your vehicle, observe the following precautions to prevent damage to the transmission and other parts.

- *Do not depress the accelerator pedal while shifting the selector lever or before the transmission is completely shifted to forward or reverse gear.*
- *Do not race the engine and avoid spinning the wheels.*
- *If your vehicle remains stuck after rocking the vehicle several times, consider other ways such as towing.*

IF YOUR VEHICLE NEEDS TO BE TOWED

If towing is necessary, we recommend you to have it done by your Lexus dealer or a commercial tow truck service. In consultation with them, have your vehicle towed using either (a) or (b).

- (a) Towing with a wheel lift type truck
- (b) Using a flat bed truck
- (c) Never tow with a sling type truck

Only when you cannot receive a towing service from a Lexus dealer or commercial tow truck service, tow your vehicle carefully in accordance with the instructions given in “(d) Emergency towing” on page 415.

Proper equipment will help ensure that your vehicle is not damaged while being towed. Commercial operators are generally aware of the state/provincial and local laws pertaining to towing.

Your vehicle can be damaged if it is towed incorrectly. Although most operators know the correct procedure, it is possible to make a mistake. To avoid damage to your vehicle, make sure the following precautions are observed. If necessary, show this page to the tow truck driver.

TOWING PRECAUTIONS:

Use a safety chain system for all towing, and abide by the state/provincial and local laws. The wheels and axle on the ground must be in good condition. If they are damaged, use a towing dolly.

IN CASE OF AN EMERGENCY

(a) Towing with a wheel lift type truck

- From front

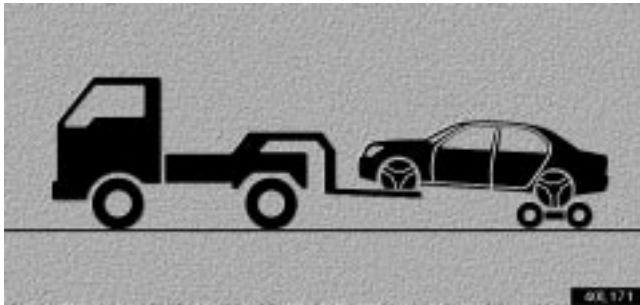

Use a towing dolly under the rear wheels.

NOTICE

Never tow a vehicle from the front with rear wheels on the ground, as this may cause serious damage to the transmission.

- From rear

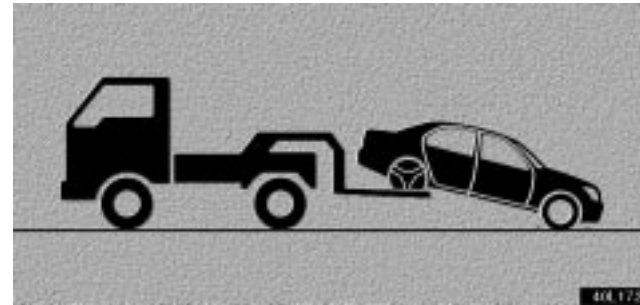

Place the ignition switch in the "ACC" position.

NOTICE

- *Do not tow with the key removed or in the "LOCK" position, as the steering lock mechanism is not strong enough to hold the front wheels straight.*
- *When lifting wheels, take care to ensure adequate ground clearance for towing at the opposite end of the raised vehicle. Otherwise, the bumper and/or underbody of the towed vehicle will be damaged during towing.*

(b) Using a flat bed truck

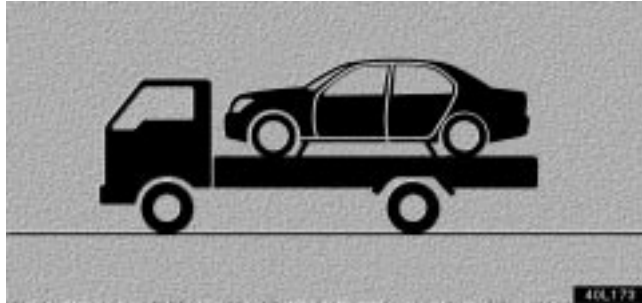

- Tie down points

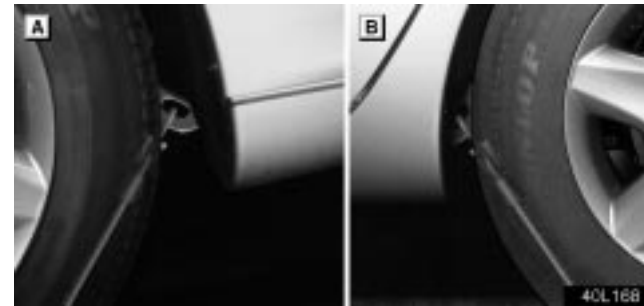
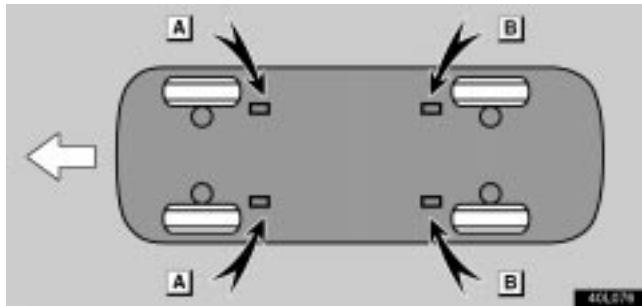

► **A** Front **B** Rear

If your Lexus is transported by a flat bed, it should be tied down at locations A and B as shown above.



► *Rear eyelets*

IN CASE OF AN EMERGENCY

NOTICE

- Do not use the rear eyelets.
- Before your vehicle is transported by flat bed, the height control switch, if so equipped, must be in the "HIGH" mode.

- Tie down angle

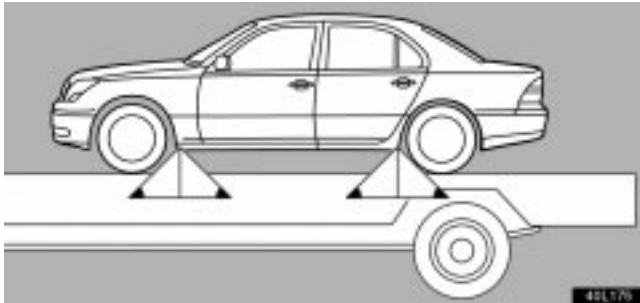

If you use chains or wires to tie down your vehicle, the angles shaded black must be at 45°.

(c) Towing with a sling type truck

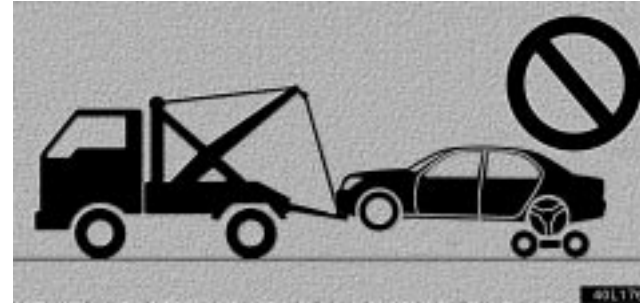

NOTICE

Do not tow with a sling type truck, either from the front or rear. This may cause body damage.

IN CASE OF AN EMERGENCY

(d) Emergency towing



If towing is necessary, we recommend you to have it done by your Lexus dealer or a commercial tow truck service.

If towing service is not available in an emergency, your vehicle may be temporarily towed by a cable or chain secured to the emergency towing eyelet. Use extreme caution when towing the vehicle.

To install the front towing eyelet, see "Installing towing eyelet" on page 417.

NOTICE

- *Only use specified towing eyelet; otherwise your vehicle may be damaged.*
- *Never tow a vehicle from the rear with four wheels on the ground. This may cause serious damage to the transmission.*

A driver must be in the vehicle to steer it and operate the brakes.

Towing in this manner may be done only on hard-surfaced roads for a short distance and at low speeds. Also, the wheels, axles, drive train, steering and brakes must all be in good condition.

CAUTION

Use extreme caution when towing the vehicle. Avoid sudden starts or erratic driving maneuvers which would place excessive stress on the emergency towing eyelet and towing cable or chain. The eyelet and towing cable or chain may break and cause serious injury or damage.

NOTICE

Use only a cable or chain specifically intended for use in towing vehicles. Securely fasten the cable or chain to the towing eyelet provided.

Before towing, release the parking brake and put the transmission in "N". The ignition switch must be in "ACC" (engine off) or "ON" (engine running).

CAUTION

If the engine is not running, the power assist for the brakes and steering will not work so steering and braking will be much harder than usual.

IN CASE OF AN EMERGENCY

Emergency towing eyelet precautions:

- Before emergency towing, check that the eyelet is not broken or damaged and that the installation bolts are not loose.
- Fasten the towing cable or chain securely to the eyelet.
- Do not jerk the eyelet. Apply steady and even force.
- To avoid damaging the eyelet, do not pull from the side or at a vertical angle. Always pull straight ahead.



CAUTION

If the emergency towing eyelet is used to get out when your vehicle becomes stuck in the mud, sand or other condition from which the vehicle cannot be driven out under its own power, make sure to observe the precautions mentioned below. Otherwise, excessive stress will be put on the eyelet and the towing cable or chain may break, causing serious injury or damage.

- **If the towing vehicle can hardly move, do not forcibly continue the towing. Contact your Lexus dealer or a commercial tow truck service for assistance.**

- **Tow the vehicle as straight ahead as possible.**
- **Keep away from the vehicle during towing.**

Tips for towing a stuck vehicle:

The following methods are effective to use when your vehicle is stuck in the mud, sand or other condition from which the vehicle cannot be driven out under its own power. Use extreme caution when towing the vehicle. In addition, keep away from the vehicles and towing cable or chain when towing.

- Remove the sand and soil in the front and the back of the tires.
- Place stones or wood under the tires.

(e) Installing towing eyelet



1. Remove the towing eyelet cover on the front bumper by pushing the right side of the cover.



2. Use the towing eyelet in the trunk. Secure it to the hole on the bumper by turning clockwise. (For the eyelet location, see page 403.)



3. Tighten the towing eyelet securely by a wheel nut wrench.

CAUTION
When installing the eyelet on the vehicle, be sure to tighten the eyelet securely. If the eyelet is loose, it may come off when being towed and result in death or serious injury.

IN CASE OF AN EMERGENCY

IF YOU CANNOT SHIFT AUTOMATIC TRANSMISSION SELECTOR LEVER

If you cannot shift the selector lever out of “P” position to other positions even though the brake pedal is depressed, use the shift lock override button as follows:

1. Turn the ignition switch to “LOCK” or “ACC”. Make sure the parking brake is applied.



2. Pry up the cover with a flat-bladed screwdriver or equivalent.



3. Push down the shift lock override button. You can shift out of “P” position only while pushing the button.

4. Shift into “N” position. Insert the cover. Start the engine. For your safety, keep the brake pedal depressed.

Be sure to have the system checked by your Lexus dealer as soon as possible.

LEXUS LINK SYSTEM (U.S.A. ONLY)



The Lexus Link System is an in-vehicle communications service that provides you with enhanced safety, security and convenience. With an active subscription you can push the “SERVICES” button for operator assistance or in an emergency situation such as a vehicle accident (in which the airbag was activated), you will automatically be connected to the Lexus Link Call Center which will assist you and/or send help 24 hours a day, 7 days a week.

The Lexus Link System can also record your voice or your conversation with the Lexus Link Call Center Advisor.

Safety information for the Lexus Link System

Important!: Read this information before using the Lexus Link System.

EXPOSURE TO RADIO FREQUENCY SIGNALS

The Lexus Link System to be installed in your vehicle is a low power radio transmitter and receiver. When the ignition is turned to the “ON” position, it receives and also sends out radio frequency (RF) signals.

In August 1996, the Federal Communications Commission (FCC) adopted RF exposure guidelines with safety levels for mobile wireless phones. Those guidelines are consistent with the safety standards previously set by both U.S. and international standards bodies.

- ANSI C95.1 (1992)*¹
- NCRP Report 86 (1986)*²
- ICNIRP (1996)*³

*1: American National Standards Institute

*2: National Council on Radiation Protection and Measurements

*3: International Commission on Non-Ionizing Radiation Protection

IN CASE OF AN EMERGENCY

Those standards were based on comprehensive and periodic evaluations of the relevant scientific literature. Over 120 scientists, engineers, and physicians from universities, government health agencies, and industry reviewed the available body of research to develop the ANSI Standard (C95.1).

The design of the Lexus Link System complies with the FCC guidelines in addition to those standards.

Information for using the Lexus Link System

The Lexus Link System is a subscription-based service. To obtain any of the Lexus Link services you must have enrolled with the Lexus Link Call Center and have an active subscription. It is important to be aware that an active subscription is required to receive safety and security services.

To learn more about your subscription status or how to renew or extend your subscription, please push the "SERVICES" button and speak to the Lexus Link Advisor, or you may dial toll free 1-800-25 Lexus (Toll-Free) (1-800-255-3987) and select the option for Lexus Link. If you are not enrolled, you will hear the explanation about Lexus Link System. The actual message is shown on "Audible voice prompts" on page 429. If you push the "SERVICES" button again, the services enrollment call will be announced. To cancel the enrollment call, push the "SERVICES" button one more time.

NOTICE

This system is only operational in GPS (Global Positioning System) and analog cellular coverage areas. Services may not be available in an area where the GPS and analog cellular phone signals cannot be received.

IN CASE OF AN EMERGENCY



NOTICE

Observe the following instructions, or reception by GPS antenna may be affected.

- *Do not place luggage (especially metallic type) on the package tray.*
- *Do not apply window tint (especially a conductive or metallic tape) by yourself. Consult with your Lexus dealer if you need to add window tint.*

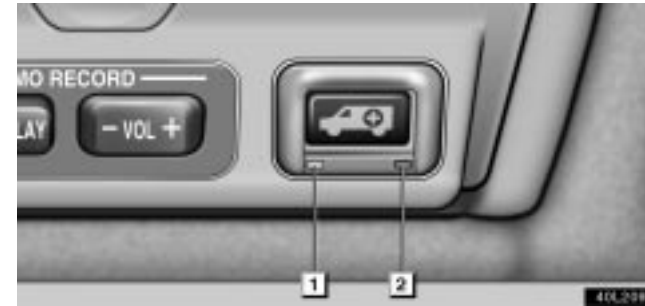

- ▶ **1** Lexus Link System indicator light (green or amber)
- 2** Lexus Link System warning light (red)

When the ignition is turned to the "ON" position, the warning light (red) should come on for a few seconds, and go off. The indicator light (amber) comes on for a few seconds and the color of the indicator changes from amber to green. This means the Lexus Link System is operating properly. The green indicator light should remain on to inform you that you have an active subscription. If your Lexus Link subscription has expired, the green indicator light should go off. To activate your Lexus Link System, press the "SERVICES" button. To learn more about your subscription status or how to renew or extend your subscription, please push the "SERVICES" button to speak to a Lexus Link Advisor, or you may dial toll free 1-800-25 Lexus (Toll-Free) (1-800-255-3987) and select the option for Lexus Link. If problems are detected in the Lexus Link System, you will hear "A Lexus Link System error has been detected. Please contact your Lexus dealer." The warning light should come on. If you hear this message, take your vehicle to your Lexus dealer.

IN CASE OF AN EMERGENCY

In some cases, even if your subscription has expired, the green indicator light may come on. This is due to the time delay required to process the deactivation of your Lexus Link System. During this period, when you push the "SERVICES" button, your call will be forwarded to enrollment. Once the deactivation process has been completed, the indicator light will go off.

NOTICE

The green indicator light is the primary means to let you know the status of your subscription. It is important to be aware that an active subscription is required to receive safety and security services. If the green indicator light is disabled, your subscription has expired. If you would like to renew your subscription for Lexus Link services, please contact Lexus Link Call Center by pushing the "SERVICES" button twice, dial toll free 1-800-25 Lexus (Toll-Free) (1-800-255-3987) and select the option for Lexus Link, or contact your Lexus dealer.

When you push the "- VOL +" button on the "-" side immediately followed by the "PLAY" button, you can hear an explanation about the Lexus Link System. However, this function is not available when you are recording or hearing a playback. See "Audible voice prompts" on page 429 for a written version of this recorder message.

The basic subscriber service package is available free of charge for the first year.

NOTICE

Do not remove the Lexus Link fuse and wiring harness with the ignition on, or an emergency call will be placed to the Lexus Link Call Center.

Automatic notifications

If an airbag deploys, an emergency signal is sent automatically to the Lexus Link Call Center. In your vehicle, the system announces “Placing an emergency call to Lexus Link Center.” In response to the signal, the Lexus Link Advisor will attempt to communicate with you first. If the Advisor cannot get any response from you, the Advisor will locate your vehicle through the GPS, call the nearest emergency services provider, describe the situation and your location. If necessary, the Advisor will transfer your call to the emergency services operator.

If the theft deterrent system on your vehicle is activated, the Lexus Link System on your vehicle will automatically call the Lexus Link Call Center. The Advisor will attempt to contact you to determine whether the alarm is valid.

If you report to the Lexus Link Call Center that your vehicle has been stolen, the Advisor will locate, track and provide location information to the appropriate law enforcement authority. To protect subscriber privacy, the Lexus Link Call Center will not provide the location of a vehicle to anyone other than a law enforcement authority.

If you accidentally activate the vehicle alarm, push the “UNLOCK” button on the wireless remote control key within 55 seconds after the alarm was set off, or insert the key into the door keyhole or ignition switch. The Lexus Link System will cancel the theft call.

NOTICE

- ***Once the emergency button is pushed, an emergency call cannot be cancelled.***
- ***If your vehicle is in area where the GPS signal is weak or cannot be received in the Lexus Link System, the color of the indicator light will change from green to amber. The system is not in operation.***
- ***This system is only operational in GPS and analog cellular coverage areas. Upon subscription expiration, all Lexus Link services (i.e. automatic notification, emergency call functions, service call functions, door locking/unlocking function) are deactivated.***

IN CASE OF AN EMERGENCY

Manual emergency calling



You can place an emergency call manually. Open the cover and push the emergency button. You will hear “Placing an emergency call to Lexus Link Center.” Upon reception of your call, the Advisor will locate your vehicle and contact you to assess the situation. If necessary, the Advisor will alert the nearest emergency service provider. This emergency call should only be made in life-threatening situations.

If your vehicle is stolen, call the Lexus Link Call Center at 1-800-25-LEXUS (Toll-Free) (1-800-255-3987). The Center will locate, track and provide location information to the appropriate police authority. To protect subscriber privacy, the Lexus Link Call Center will not provide the location of a vehicle to anyone other than a law enforcement authority.

NOTICE

- *If your vehicle is in area where the GPS signal is weak or cannot be received in the Lexus Link System, the color of the indicator light will change from green to amber. The system is not in operation.*
- *This system is only operational in GPS and analog cellular coverage areas. Upon subscription expiration, all Lexus Link services (i.e. automatic notification, emergency call functions, service call functions, door locking/unlocking function) are deactivated.*

IN CASE OF AN EMERGENCY

Other Services



When you push the “SERVICES” button, you will hear “Calling the Lexus Link Center”. When the Advisor receives your location and ID from the system, the Advisor provides you with the service. The services provided will depend on the level of service package selected.

For details about various services that are available, contact your Lexus dealer, or push the “SERVICES” button and speak to the Lexus Link Advisor, or you may dial toll free 1-800-25 Lexus (Toll-Free) (1-800-255-3987) and select the option for Lexus Link.

To cancel a services call, push the “SERVICES” button a second time. “Lexus Link call cancelled” will be announced.

If any problem concerning the Lexus Link System occurs during driving, the system will announce “A Lexus Link System error has been detected. Please contact your Lexus dealer.” If you hear this message, take your vehicle to your Lexus dealer.

Lexus Link services may not be available in the following cases.

- The components or wire harnesses for the system are damaged.
- The Lexus Link Call Center is not operational.
- The antenna does not work properly due to vehicle damage.
- In a weak or non-analog cellular coverage area.
- Your vehicle is in area where the GPS signal is weak or cannot be received.
- The Lexus Link subscription has expired.

NOTICE

Upon subscription expiration, all Lexus Link services (i.e. automatic notification, emergency call functions, service call functions) are deactivated.

IN CASE OF AN EMERGENCY

Door Locking/Unlocking by Lexus Link System

The Lexus Link System will allow your vehicle to be locked and unlocked remotely.

If you find that your vehicle has not been locked, call the Lexus Link Call Center 1-800-25-LEXUS (Toll-Free) (1-800-255-3987), the Lexus Link Advisor can assist in locking your vehicle.

In case you are locked out, call the Lexus Link Call Center 1-800-25 Lexus (Toll-Free) (1-800-255-3987), a Lexus Link Advisor can assist in unlocking your vehicle.

NOTICE

You must provide the Lexus Link operator with your Lexus Link PIN (Personal Identification Number) or personal security word, before they lock/unlock your vehicle. However, the Lexus Link System will not be able to lock or unlock your vehicle if it has been parked for 48 hours or more after the ignition is turned off. Upon subscription expiration, all Lexus Link services (i.e. automatic notification, emergency call functions, service call functions, door locking/unlocking function) are deactivated.

Memo record



- **1** “REC” button **2** “PLAY” button
3 “- VOL +” button

During a service call, you can record a conversation with the Lexus Link Call Center Advisor. This function is very convenient for drivers so they do not have to take notes while driving.

“REC” button: Push this button to record information or a conversation with Lexus Link Call Center. To stop recording, push the button again. Up to 5 minutes of recording time is available.

When you push the “REC” button, all previous messages are deleted and the system begins recording your new message.

IN CASE OF AN EMERGENCY

At the start of recording, "Recording" will be announced. At the end of recording, you will hear "Recording complete". If there are only 15 seconds left for recording, two chimes sound. If the recording memory is full, "Recording time exceeded" will be announced and recording will be terminated.

If you push this button while you are hearing a playback of recording, it terminates the playback and recording will start. At this time, the previous recording will be erased.

"PLAY" button: Push this button to play the recorded conversation. "Playback Complete" is announced when the playback is complete. To stop the operation, push the button again. "Playback Cancelled" is announced. The volume has a total of seven positions/levels available.

"- VOL +" button: Push this button on either side to adjust the volume. When you change the volume, one chime sounds.

Lexus Link System indicator and warning lights

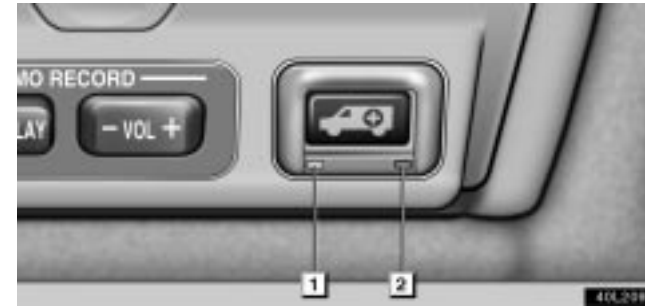

- ▶ **1** Lexus Link System indicator light (green or amber)
- 2** Lexus Link System warning light (red)

IN CASE OF AN EMERGENCY

When the green indicator light remains on, you have an active subscription. You can obtain any of the Lexus Link services.

When the green indicator light starts flashing, the Lexus Link Call Center is connected.

When the color of the indicator light changes from green to amber, the GPS signal is weak or cannot be received.

If something is placed on the package tray, remove it. It may be interfering the GPS signal reception.

If nothing is placed on the package tray and the amber indicator light remains on for about 10 minutes or more, contact your Lexus dealer.

When the engine is turned off and then restarted, the indicator color changes to green. However, if the color of the indicator light changes to amber again after 10 minutes or more, contact your Lexus dealer.

When the warning light remains on, there is any problem with the Lexus Link system.

When the indicator and warning lights go off, your subscription has expired.

Audible voice prompts

The following table shows the voice responses from the Lexus Link System.

Voice phrase: Explanation about Lexus Link System		
<p>This is the Lexus Link system. Integrating global positioning satellite and wireless communication technology into your Lexus and providing enhanced safety, security, and convenience. At the touch of a button, or automatically in the event of an accident, you are connected to a Lexus Link Advisor who will assist you - 24 hours a day, 7 days a week where GPS and cellular coverage is available. The Lexus Link System also has an audio recorder allowing you to record reminders to yourself or information from a Lexus Link Advisor.</p> <p>To contact a Lexus Link Advisor, press the "SERVICES" button. The Lexus Link System will inform the advisor of your vehicle's current location and your identity. The advisors can handle a wide variety of services, such as giving directions to shops, gas stations, ATMs, restaurants and roadside assistance with location. Services available will depend on the service package you selected.</p>	<p>In an emergency, press the emergency services button on your Lexus Link console. It is marked with a red ambulance. Upon receiving your call, the advisor will assess the situation and, if necessary, alert the nearest emergency services provider. The emergency button should only be used in life threatening situations.</p> <p>If your Lexus detects that an airbag deployment may have occurred, the Lexus Link System will automatically send an emergency message to the Lexus Link Call Center.</p> <p>The system will also automatically contact the call center if the security system alarm goes off. An advisor will first contact you to determine if the alarm is valid. Upon your confirmation, the advisor will then provide the vehicle location to the police.</p>	<p>If you accidentally set off the alarm, press the remote door unlock, or insert your key in the door lock or ignition within 55 seconds. This will prevent the Lexus Link System from placing a theft call.</p> <p>The volume control lets you adjust the volume level for Lexus Link calls, system prompts, and memos. Press the plus key to increase volume and the minus key to decrease it.</p> <p>To record a memo or a call, press the key labeled "REC". When you are finished recording, press the "REC" button again. To listen to the memo, press the "PLAY" button. You can record one message up to five minutes long. When you record a new memo, all of the previous memos will be erased.</p> <p>For more detailed information on the use, features and limitations of this system, please consult your Lexus Link Owner's Manual.</p>

IN CASE OF AN EMERGENCY

Voice phrase	Description
Placing an emergency call to Lexus Link Center	Emergency call is placed.
Calling the Lexus Link Center	Service call is placed.
Lexus Link Call cancelled	Service call is cancelled.
Previous attempt to call the Lexus Link Center was unsuccessful.	The attempt to call the Lexus Link Center was unsuccessful.
Recording	The recording will start.
Recording complete	The recording is complete.
Recording time exceeded	The recording memory is now full.
Playback complete	The playback is complete.
Playback cancelled	The playback is cancelled.
A Lexus Link System error has been detected. Please contact your Lexus dealer.	An error has been detected with the Lexus Link System. Contact your Lexus dealer.

Voice phrase	Description
Your Lexus Link subscription has expired. Services are not available.	You operated a Lexus Link button despite an expired subscription. Your Lexus Link subscription has expired, push the "Services" button a second time to reactivate.
No cellular service available. Unable to contact the Call Center.	In cellular coverage areas without analog coverage, you cannot use the Lexus Link System. Unable to contact the Lexus Link Call Center until you have cellular coverage.

Lexus Link transceiver antenna



The Lexus Link transceiver antenna is removable. Before taking the vehicle to an automatic car wash, disconnect the antenna by unscrewing it from the roof mount.

When you remove the antenna, make sure the ignition is turned off.

Use only the supplied or an approved antenna. Unauthorized antennas, modifications, or attachments could damage the Lexus Link System and may violate FCC regulations.

CAUTION

Persons who use a medical appliance like a pacemaker should not touch or come in close contact with the antenna while the vehicle ignition is on. Otherwise, the analog cellular signals may produce improper operation of a medical appliance.

NOTICE

- *Do not contact with the antenna, this may affect quality of transceiver's operation and may cause the unit to operate at a higher power level than needed.*
- *If you forget reattaching the Lexus Link transceiver antenna, the Lexus Link System may not function properly.*
- *To prevent damage to the antenna, make sure it is removed before driving your vehicle through an automatic car wash.*

IN CASE OF AN EMERGENCY

IF YOU LOSE YOUR KEYS OR LOCK YOURSELF OUT

You can purchase a new key at your Lexus dealer if you can give them the key number and master key.

Even if you lose only one key, contact your Lexus dealer to make a new key. If you lose all your master keys, you cannot make new keys; the whole engine immobilizer system must be replaced.

See the suggestion given in “Keys” on page 10.

You can use the wireless remote control system with the new key. Contact your Lexus dealer for detailed information.

If your keys are locked in the vehicle and you cannot get a duplicate, many Lexus dealers can still open the door for you using special tools. If your vehicle is equipped with Lexus Link System, call the Lexus Link Call Center 1-800-25-LEXUS (Toll-Free) (1-800-255-3987). Once you provide the Lexus Link Call Center Advisor with your Lexus Link PIN (Personal Identification Number), or personal security word, they will unlock your vehicle.

NOTICE

You must provide the Lexus Link operator with your Lexus Link PIN (Personal Identification Number) or personal security word, before they lock/unlock your vehicle. However, the Lexus Link System will not be able to lock or unlock your vehicle if it has been parked for 48 hours or more after the ignition is turned off. Upon subscription expiration, all Lexus Link services (i.e. automatic notification, emergency call functions, service call functions) are deactivated.

If you must break a window to get in, we suggest breaking the smallest side window because it is the least expensive to replace. Be extremely cautious to avoid glass cuts.

7
-

SECTION 5

MAINTENANCE

Maintenance

Maintenance requirements	435
General maintenance	436
Does your vehicle need repairing?	439
Emissions inspection and maintenance (I/M) programs	440

For scheduled maintenance information, please refer to the "Owner's Manual Supplement / Scheduled Maintenance".

MAINTENANCE REQUIREMENTS

Your Lexus vehicle has been designed to have fewer maintenance requirements with longer service intervals to save both your time and money. However, each regular maintenance as well as day-to-day care is more important than ever before to ensure smooth, trouble-free, safe, and economical driving.

It is the owner's responsibility to make sure the specified maintenance, including general maintenance services, is performed. Note that both the new vehicle and emission control system warranties specify that proper maintenance and care must be performed. See "Owner's Guide", "Owner's Manual Supplement" or "Warranty Booklet" for complete warranty information.

General maintenance

General maintenance items are those day-to-day care practices that are important to your vehicle for proper operation. It is the owner's responsibility to ensure that the general maintenance items are performed regularly.

These checks or inspections can be done either by yourself or your Lexus dealer.

Scheduled maintenance

The scheduled maintenance items listed in the "Owner's Manual Supplement / Scheduled Maintenance" are those required to be serviced at regular intervals.

For details of your maintenance schedule, read the "Owner's Manual Supplement / Scheduled Maintenance".

It is recommended that only genuine Lexus parts be used for maintenance or for the repair of the emission control system.

The owner may elect to use non-Lexus supplied parts for replacement purposes without invalidating the emission control system warranty. However, use of replacement parts which are not of equivalent quality may impair the effectiveness of the emission control systems.

You may also elect to have maintenance, replacement, or repair of the emission control devices and system performed by any automotive repair establishment or individual without invalidating this warranty. See "Owner's Guide", "Owner's Manual Supplement" or "Warranty Booklet" for complete warranty information.

MAINTENANCE

Where to go for service?

Lexus technicians are well-trained specialists and are kept up to date with the latest service information through technical bulletins, service tips, and in-dealership training programs. They are well informed about the operation of all the systems on your vehicle.

You can be confident that your Lexus dealer's service department performs the best job to meet the maintenance requirements of your vehicle - reliably and economically.

Your copy of the repair order is proof that all required maintenance has been performed for warranty coverage. If any problems should arise with your vehicle while under warranty, your Lexus dealer will promptly take care of it. Again, be sure to keep a copy of the repair order for any service performed on your Lexus.

What about do-it-yourself maintenance?

Many of the maintenance items are easy to do yourself, if you have a little mechanical ability and a few basic automotive tools. Simple instructions for how to perform them are presented in Section 6.

If you are a skilled do-it-yourself mechanic, the Lexus service manuals are recommended. Please be aware that do-it-yourself maintenance can affect your warranty coverage. See "Owner's Guide", "Owner's Manual Supplement" or "Warranty Booklet" for the details.

GENERAL MAINTENANCE

Listed below are the general maintenance items that should be performed at the intervals specified. It is recommended that any problem you notice be brought to the attention of your Lexus dealer or qualified service shop for their advice.

CAUTION

Make these checks only with adequate ventilation if you run the engine.

Engine compartment

Items listed below should be checked from time to time, e.g. each time when refueling.

Washer fluid

Make sure there is sufficient fluid in the tank. See page 512 for additional information.

Engine coolant level

Make sure the coolant level is between the Upper and Lower lines on the see-through reservoir when the engine is cold. See page 464 for additional information.

Radiator, condenser and hoses

Check that the front of the radiator and condenser are clean and not blocked with leaves, dirt, or insects. See page 466 for additional information.

Battery

Your Lexus has a maintenance free battery. You do not have to add distilled water. For longer life of the battery, however, see page 505 for additional information.

Brake fluid level

Make sure the brake fluid level is correct. See page 474 for additional information.

Engine oil level

Check the level on the dipstick with the engine turned off and the vehicle parked on a level spot. See page 461 for additional information.

Power steering fluid level

Check the level through the reservoir. The level should be in the "HOT" or "COLD" range depending on the fluid temperature. See page 475 for additional information.

Exhaust system

If you notice any change in the sound of the exhaust or smell exhaust fumes, have the cause located and corrected immediately. (See "Engine exhaust cautions" on page 294.)

Vehicle interior

Items listed below should be checked regularly, e.g. while performing periodic services, cleaning the vehicle, etc.

Lights

Make sure the headlights, stop lights, tail lights, turn signal lights, and other lights are working. Check headlight aim.

Service reminder indicators and warning buzzers

Check that all service reminder indicators and warning buzzers function properly.

Steering wheel

Check that it has the specified free play. Be alert for changes in steering condition, such as hard steering, excessive free play or strange noise.

Seats

Check that all front seat controls such as seat adjusters, seatback recliner, etc. operate smoothly. Check that the head restraints move up and down smoothly and that the locks hold securely in any latched position.

Seat belts

Check that the seat belt system such as buckles, retractors and anchors operate properly and smoothly. Make sure the belt webbing is not cut, frayed, worn or damaged.

MAINTENANCE

Accelerator pedal

Check the pedal for smooth operation and uneven pedal effort or catching.

Brake pedal

Check the pedal for smooth operation and the proper clearance and free play. Check the brake booster function.

Brakes

In a safe place, check that the brakes do not pull to one side when applied.

Parking brake

Check that the pedal has the proper travel and that, on a safe incline, your vehicle is held securely with only the parking brake applied.

Automatic transmission “Park” mechanism

On a safe incline, check that your vehicle is held securely with the selector lever in “P” position and all brakes released.

Vehicle exterior

Items listed below should be performed from time to time, unless otherwise specified.

Fluid leaks

Check underneath for leaking fuel, oil, water or other fluid after the vehicle has been parked for a while. If you smell fuel fumes or notice any leak, have the cause found and corrected immediately.

Doors and engine hood

Check that all doors, including trunk lid, operate smoothly and all latches lock securely. Make sure the engine hood secondary latch secures the hood when the primary latch is released.

Wheel nuts

When checking the tires, make sure to check the nuts for looseness. Tighten them if necessary.

Tire inflation pressure

Check the pressure with a gauge every two weeks, or at least once a month and adjust as shown on the tire loading and information label. See page 476 for additional information.

Tire surface

Check the tires carefully for cuts, damage or excessive wear. See page 490 for additional information.

Tire rotation

Rotate the tires according to the maintenance schedule. (For scheduled maintenance information, please refer to the “Owner’s Manual Supplement / Scheduled Maintenance”). See page 489 for additional information.

DOES YOUR VEHICLE NEED REPAIRING?

Be on the alert for changes in performance and sounds, and visual tip-offs that indicate service is needed. Some important clues are:

- Engine missing, stumbling, or pinging
- Appreciable loss of power
- Strange engine noises
- A fluid leak under the vehicle (However, water dripping from the air conditioning after use is normal.)
- Change in exhaust sound (This may indicate a dangerous carbon monoxide leak. Drive with the windows open and have the exhaust system checked immediately.)
- Flat-looking tires, excessive tire squeal when cornering, uneven tire wear
- Vehicle pulls to one side when driving straight on a level road
- Strange noises related to suspension movement
- Loss of brake effectiveness, spongy feeling brake pedal, pedal almost touches floors, vehicle pulls to one side when braking
- Engine coolant temperature continually higher than normal

If you notice any of these clues, take your vehicle to your Lexus dealer as soon as possible. It probably needs adjustment or repair.

MAINTENANCE



CAUTION

Do not continue driving with the vehicle unchecked. It could result in serious vehicle damage and possibly personal injury.

EMISSIONS INSPECTION AND MAINTENANCE (I/M) PROGRAMS

Some states have vehicle emission inspection programs which include OBD (On-Board Diagnostics) checks.

The OBD system monitors the operation of the emission control system. When the OBD system determines that a problem exists somewhere in the emission control system, the malfunction indicator lamp comes on. In this case, your vehicle may not pass the I/M test and need to be repaired. Contact your Lexus dealer to service the vehicle.

Even if the malfunction indicator lamp does not come on, your vehicle may not pass the I/M test as readiness codes have not been set in the OBD system.

Readiness codes are automatically set during ordinary driving. However, when the battery is disconnected or run down, the codes are erased. Also, depending on your driving habits, the codes may not be completely set.

Also, if the malfunction indicator lamp had come on recently due to temporary malfunction such as a loose fuel tank cap, your vehicle may not pass the I/M test.

The malfunction indicator lamp will go off after taking several driving trips, but the error code in the OBD system will not be cleared unless about 40 trips or more are taken.

If your vehicle does not pass the I/M test and the malfunction indicator lamp does not come on, contact your Lexus dealer to prepare the vehicle for re-testing.

⋮

SECTION 6-1

SERVICE PROCEDURES AND SPECIFICATIONS

Introduction

Vehicle identification	443
Theft prevention labels	444
Engine compartment overview	445
Do-it-yourself service precautions	446
Parts and tools	448
Positioning the jack	449

VEHICLE IDENTIFICATION



The vehicle identification number (VIN) is the legal identifier for your vehicle. This number is on the left top of the instrument panel and can be seen through the windshield from outside.

This is the primary identification number for your Lexus. It is used in registering the ownership of your vehicle.



The vehicle identification number (VIN) is also on the Certification Label.



The engine number is stamped on the engine block as shown.

INTRODUCTION

THEFT PREVENTION LABELS (U.S.A. ONLY)



Your new vehicle carries theft prevention labels which are approximately 47 mm (1.85 in.) by 12 mm (0.47 in.).

The purpose of these labels is to reduce the incidence of vehicle thefts by facilitating the tracing and recovery of parts from stolen vehicles. The label is designed so that once it is applied to a surface, any attempt to remove it will result in destroying the integrity of the label. Transferring these labels intact from one part to another will be impossible.

NOTICE

You should not attempt to remove the theft prevention labels as it may violate certain state or federal laws.

ENGINE COMPARTMENT OVERVIEW

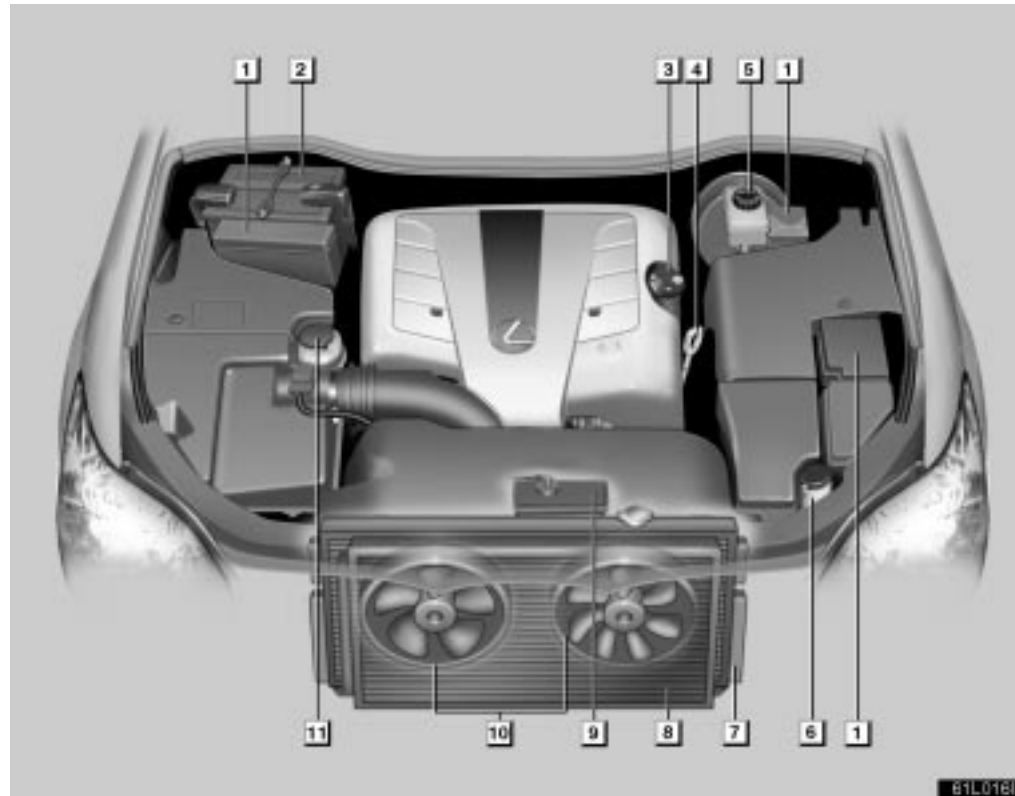

- 1 Fuse box
- 2 Battery
- 3 Engine oil filler cap
- 4 Engine oil level dipstick
- 5 Brake fluid reservoir
- 6 Washer fluid tank
- 7 Radiator
- 8 Condenser
- 9 Engine coolant reservoir
- 10 Electric cooling fans
- 11 Power steering fluid reservoir

INTRODUCTION

DO-IT-YOURSELF SERVICE PRECAUTIONS

If you perform maintenance yourself, be sure to follow the correct procedure given in this Section.

You should be aware that improper or incomplete servicing may result in operating problems.

Performing do-it-yourself maintenance during the warranty period may affect your warranty coverage. Read the separate Lexus Warranty statement for details and suggestions.

This Section gives instructions only for those items that are relatively easy for an owner to perform. As explained in Section 5, there are still a number of items that must be performed by a qualified technician with special tools.

For information on tools and parts for do-it-yourself maintenance, see "Parts and tools" on page 448.

Utmost care should be taken when working on your vehicle to prevent accidental injury. Here are a few precautions that you should be especially careful to observe:

CAUTION

- When the engine is running, keep hands, clothing, and tools away from the moving fan and engine drive belt. (Removing rings, watches, and ties is advisable.)
- Right after driving, the engine compartment - the engine, radiator, exhaust manifold and power steering fluid reservoir, etc. - will be hot. So be careful not to touch them. Oil and other fluids may also be hot.
- Do not leave anything that may burn easily, such as paper or rags, in the engine compartment.
- Do not smoke, cause sparks or allow open flames around fuel or the battery. Their fumes are flammable.
- Do not get under your vehicle with just the body jack supporting it. Always use automotive jack stands or other solid supports.
- Be sure the ignition is off if you work near the electric cooling fan or radiator grille. With the ignition on, the electric cooling fan may automatically start to run if the air conditioning is on and/or if the coolant temperature is high.
- Use eye protection whenever you work on or under your vehicle where you may be exposed to flying or falling material, fluid spray, etc.
- Be extremely cautious when working on the battery. It contains poisonous and corrosive sulfuric acid.

- **Warning:** Battery posts, terminals and related accessories contain lead and lead compounds, chemicals known to the State of California to cause cancer and reproductive harm. Wash hands after handling.

NOTICE

- *Remember that battery and ignition cables carry high currents or voltages. Be careful of accidentally causing a short circuit.*
- *Add only "Toyota Super Long Life Coolant" or similar high quality ethylene glycol based non-silicate, non-amine, non-nitrite, and non-borate coolant with long-life hybrid organic acid technology to fill the radiator. "Toyota Super Long Life Coolant" is a mixture of 50% coolant and 50% deionized water.*
- *If you spill some of the coolant, be sure to wash it off with water to prevent it from damaging the parts or paint.*
- *Before closing the engine hood, check to see that you have not forgotten any tools, rags, etc.*
- *Do not drive with the air cleaner removed, or excessive engine wear could result. Also backfiring could cause a fire in the engine compartment.*
- *If you spill the fluid, be sure to wash it off with water to prevent it from damaging the parts or paint.*
- *Do not overfill automatic transmission fluid, transfer oil and power steering fluid, or the transmission and power steering could be damaged.*
- *Be careful not to scratch the glass surface with the wiper frame.*

INTRODUCTION

PARTS AND TOOLS

Here is a list of parts and tools you will need to perform do-it-yourself maintenance. Remember all Lexus parts are designed in metric sizes, so your tools must be metric.

Checking the engine oil level

Parts (if level is low):

- “Toyota Genuine Motor Oil” or equivalent
Oil grade: API grade SL “Energy-Conserving” or ILSAC multigrade engine oil. For recommended oil viscosity, see page 463.

Tools:

- Rag or paper towel
- Funnel (only for adding oil)

Checking the engine coolant level

Parts (if level is low):

- “Toyota Super Long Life Coolant” or similar high quality ethylene glycol based non-silicate, non-amine, non-nitrite, and non-borate coolant with long-life hybrid organic acid technology.

“Toyota Super Long Life Coolant” is a mixture of 50% coolant and 50% deionized water.

- Distilled water

Tools:

- Funnel (only for adding coolant)

Checking brake fluid

Parts (if level is low):

- FMVSS No. 116 DOT 3 or SAE J1703 brake fluid

Tools:

- Funnel (only for adding fluid)

Checking power steering fluid

Parts (if level is low):

- Automatic transmission fluid DEXRON® II or III

Tools:

- Rag or paper towel
- Funnel (only for adding fluid)

Checking battery condition

Tools:

- Warm water
- Baking soda
- Grease
- Conventional wrench (for terminal clamp bolts)

Checking and replacing the blade type fuses

Parts (if replacement is necessary):

- Fuse with same amperage rating as original

Checking the cartridge type fuses

Parts (if replacement is necessary):

- Genuine Lexus fuse or equivalent with same amperage rating as original

Adding washer fluid

Parts:

- Water
- Washer fluid containing antifreeze (for winter use)

Tools:

- Funnel

POSITIONING THE JACK

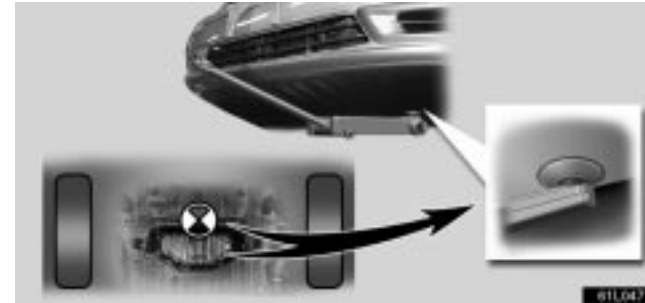

► *Front*



► *Rear*

When jacking up your vehicle with the jack, position the jack correctly as shown in the illustrations.

INTRODUCTION



CAUTION

When jacking, be sure to observe the following to reduce the possibility of personal injury:

- Follow jacking instructions.
- Do not put any part of your body under the vehicle supported by the jack. Otherwise, personal injury may occur.
- Do not start or run the engine while your vehicle is supported by the jack.
- Stop the vehicle on a level firm ground, firmly set the parking brake and put the transmission in "P". Block the wheels on the opposite side of the jack up point if necessary.
- Make sure to set the jack properly in the jack point. Raising the vehicle with jack improperly positioned will damage the vehicle or may allow the vehicle to fall off the jack and cause personal injury.
- Never get under the vehicle when the vehicle is supported by the jack alone; use vehicle support stands.
- Do not raise the vehicle with someone in the vehicle
- When raising the vehicle, do not place any objects on top of or underneath the jack.
- For vehicles equipped with the height control switch, be sure to turn the ignition switch off before jacking. If this is not done, the vehicle height adjustment function will operate, which may cause an accident.

NOTICE

Make sure to place the jack correctly, or your vehicle may be damaged.

!

SECTION 6-2

SERVICE PROCEDURES AND SPECIFICATIONS

Engine

Specifications	453
Fuel	456
Fuel pump shut off system	458
Facts about engine oil consumption	459
Used engine oil	460
Checking the engine oil level	461
Checking the engine coolant level	464
Checking the radiator and condenser	466
Spark plugs	466

SPECIFICATIONS**- GENERAL**

Model	3UZ-FE
Type	8 cylinder V type, 4 cycle, gasoline
Bore and stroke	91.0 X 82.5 mm (3.58 X 3.25 in.)
Displacement	4293 cm ³ (262.0 cu.in.)
Valve clearance (engine cold) Intake Exhaust	0.15 - 0.25 mm (0.006 - 0.010 in.) 0.25 - 0.35 mm (0.010 - 0.014 in.)
Drive belt tension	Automatic adjustment

- FUEL

Fuel type	Only UNLEADED
Octane rating	91 (Research octane number 96) or higher

ENGINE

– LUBRICATION SYSTEM

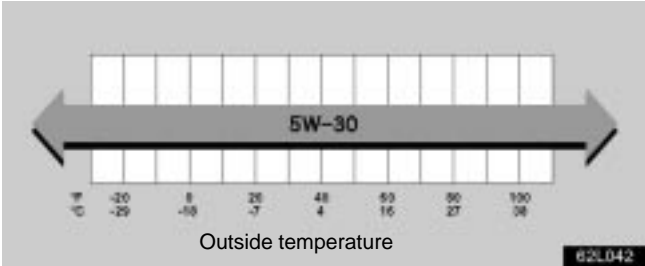
Oil capacity Drain and refill with filter without filter	5.1 L (5.4 qt., 4.5 Imp.qt.) 4.5 L (4.8 qt., 4.0 Imp.qt.)
Oil grade	API grade SL “Energy-Conserving” or ILSAC multigrade engine oil
Recommended oil viscosity (SAE):	5W-30 

NOTE:

“Toyota Genuine Motor Oil” is used in your Lexus vehicle. Use Lexus approved “Toyota Genuine Motor Oil” or equivalent to satisfy the above grade and viscosity. Please contact your Lexus dealer for further details.

ENGINE

– COOLING SYSTEM

Capacity	9.5 L (10.0 qt., 8.4 Imp.qt.)
Coolant type	“Toyota Super Long Life Coolant” or similar high quality ethylene glycol based non-silicate, non-amine, non-nitrite, and non-borate coolant with long-life hybrid organic acid technology Do not use plain water alone.

NOTE:

“Toyota Super Long Life Coolant” is used in your Lexus vehicle at factory fill. In order to avoid technical problems, only use “Toyota Super Long Life Coolant” or similar high quality ethylene glycol based non-silicate, non-amine, non-nitrite, and non-borate coolant with long-life hybrid organic acid technology. Please contact your Lexus dealer for further details.

– IGNITION SYSTEM

Spark plug	– Make	DENSO NGK	SK20R11 IFR6A11
	– Gap		1.1 mm (0.043 in.)

– ELECTRICAL SYSTEM

Battery – Open voltage at 20°C (68°F):	12.7 V Fully charged 12.3 V Half charged 11.9 V Discharged [Voltage that is checked 20 minutes after the key is removed with all the lights turned off]
– Charging rates	5A max.

ENGINE

FUEL

Fuel type

Your vehicle must use only unleaded gasoline.

To help prevent gas station mixups, your Lexus has a smaller fuel tank opening. The special nozzle on pumps with unleaded fuel will fit it, but the larger standard nozzle on pumps with leaded gas will not.

At a minimum, the gasoline you use should meet the specifications of ASTM D4814 in the U.S.A. and CGSB 3.5-M93 in Canada.

NOTICE

Do not use leaded gasoline. Use of leaded gasoline will cause the three-way catalytic converter to lose its effectiveness and the emission control system to function improperly. Also, this can increase maintenance costs.

Octane rating

Select premium unleaded gasoline with an Octane Rating of 91 (Research Octane Number 96) or higher for optimum engine performance. However, if such premium type cannot be obtained, you may temporarily use unleaded gasoline with an Octane Rating as low as 87 (Research Octane Number 91).

Use of unleaded fuel with an octane number or rating lower than stated above will cause persistent heavy knocking. If severe, this will lead to engine damage.

If your engine knocks ...

If you detect heavy knocking even when using the recommended fuel, or if you hear steady knocking while holding a steady speed on level roads, consult your Lexus dealer.

However, occasionally, you may notice light knocking for a short time while accelerating or driving up hills. This is normal and there is no need for concern.

Gasoline containing detergent additives

Lexus recommends the use of gasoline that contains detergent additives to avoid build-up of engine deposits.

However, all gasoline sold in the U.S. contains detergent additives to keep clean and/or clean intake systems.

Quality gasoline

Automotive manufacturers in the U.S., Europe and Japan have developed a specification for quality fuel named World-Wide Fuel Charter (WWFC) that is expected to be applied world wide. The WWFC consists of four categories that depend on required emission levels. In the U.S., category 3 has been adopted. The WWFC improves air quality by providing for better emissions in vehicle fleets, and customer satisfaction through better vehicle performance.

Cleaner burning gasoline

Cleaner burning gasoline, including reformulated gasoline that contains oxygenates such as ethanol or MTBE is available in many areas.

Lexus recommends the use of cleaner burning gasoline and appropriately blended reformulated gasoline. These types of gasoline provide excellent vehicle performance, reduce vehicle emissions, and improve air quality.

Oxygenates in gasoline

Lexus allows the use of oxygenate blended gasoline where the oxygenate content is up to 10% ethanol or 15% MTBE. If you use gasohol in your Lexus, be sure that it has an octane rating no lower than 87.

Lexus does not recommend the use of gasoline containing methanol.

Gasoline containing MMT

Some gasoline contain an octane enhancing additive called MMT (Methylcyclopentadienyl Manganese Tricarbonyl).

Lexus does not recommend the use of gasoline that contains MMT. If fuel containing MMT is used, your emission control system may be adversely affected. The Malfunction Indicator Lamp on the instrument cluster may come on. If this happens, contact your Lexus dealer for service.

Gasoline quality

In a very few cases, you may experience driveability problems caused by the particular gasoline that you are using. If you continue to have unacceptable driveability, try changing gasoline brands. If this does not rectify your problem, then consult your Lexus dealer.

NOTICE

- ***Do not use gasohol other than stated above. It will cause fuel system damage or vehicle performance problems.***
- ***If drivability problems are encountered (poor hot starting, vaporizing, engine knock, etc.), discontinue its use.***

ENGINE

- *Take care not to spill gasohol during refueling. Gasohol may cause paint damage.*

Fuel tank capacity

84 L (22.2 gal., 18.5 Imp.gal.)

FUEL PUMP SHUT OFF SYSTEM

The fuel pump shut off system stops supplying fuel to the engine to minimize the risk of fuel leakage when the engine stalls or an airbag inflates upon collision. To restart the engine after the fuel pump shut off system activates, turn the ignition switch to “ACC” or “LOCK” once and start it.

CAUTION

Inspect the ground under the vehicle before restarting the engine. If you find that liquid has leaked onto the ground, it is the fuel system that has been damaged and it is in need of repair. In this case, do not restart the engine.

FACTS ABOUT ENGINE OIL CONSUMPTION

Functions of engine oil

Engine oil has the primary function of lubricating and cooling the inside of the engine, and plays a major role in maintaining the engine in proper working order.

Engine oil consumption

It is normal that an engine should consume some engine oil during normal engine operation. The causes of oil consumption in a normal engine are as follows.

- Oil is used to lubricate pistons, piston rings and cylinders. A thin film of oil is left on the cylinder wall when a piston moves downwards in the cylinder. High negative pressure generated when the vehicle is decelerating sucks some of this oil into the combustion chamber. This oil as well as some part of the oil film left on the cylinder wall is burned by the high temperature combustion gases during the combustion process.
- Oil is also used to lubricate the stems of the intake valves. Some of this oil is sucked into the combustion chamber together with the intake air and is burned along with the fuel. High temperature exhaust gases also burn the oil used to lubricate the exhaust valve stems.

The amount of engine oil consumed depends on the viscosity of the oil, the quality of the oil and the way the vehicle is driven.

More oil is consumed by high-speed driving and frequent acceleration and deceleration.

A new engine consumes more oil, since its pistons, piston rings and cylinder walls have not become conditioned.

Oil consumption: Max. 1.0 L per 1000 km (1.1 qt./600 miles, 0.9 Imp. qt./600 miles)

When judging the amount of oil consumption, keep in mind that the oil may have become diluted, making it difficult to judge the true level accurately.

For example, if a vehicle is used for repeated short trips and consumes a normal amount of oil, the dipstick may not show any drop in the oil level at all, even after 1000 km (600 miles) or more. This is because the oil is gradually becoming diluted with fuel or moisture, making it appear that the oil level has not changed.

The diluting ingredients evaporate out when the vehicle is then driven at high speeds, as on an expressway, making it appear that oil is excessively consumed after driving at high speeds.

ENGINE

Importance of engine oil level check

One of the most important points in proper vehicle maintenance is to keep the engine oil at the optimum level so that oil function will not be impaired. Therefore, it is essential that the oil level be checked regularly. Lexus recommends that the oil level be checked every time you refuel the vehicle.

NOTICE

Failure to check the oil level regularly could lead to serious engine trouble due to insufficient oil.

For detailed information on oil level check, see "Checking the engine oil level" described below.

USED ENGINE OIL

CAUTION

- **Used engine oil contains potentially harmful contaminants which may cause skin disorders such as inflammation or skin cancer, so care should be taken to avoid prolonged and repeated contact with it. To remove used engine oil from your skin, wash thoroughly with soap and water.**
- **Do not leave used oil within the reach of children.**
- **Dispose of used oil and used oil filters only in a safe and acceptable manner. Do not dispose of used oil and used oil filters in household trash, in sewers or onto the ground. Call your Lexus dealer or a service station for information concerning recycling or disposal.**

CHECKING THE ENGINE OIL LEVEL



With the engine at operating temperature and turned off, check the oil level on the dipstick.

1. To get a correct reading, the vehicle should be on level ground. After turning off the engine, wait a few minutes for the oil to drain back into the bottom of the engine.
2. Pull the dipstick out, hold a rag under the end and wipe it clean.
3. Reinsert the dipstick and push it in as far as it will go, or the reading will not be correct.

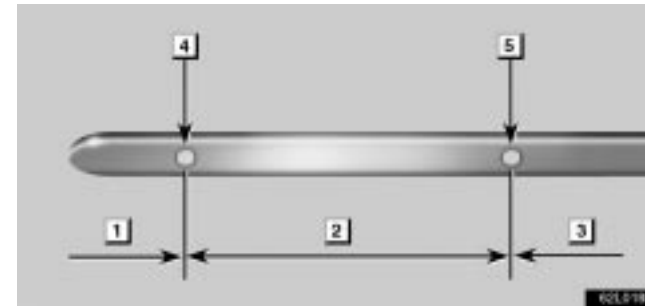

► **1** Add oil **2** O.K. **3** Too full

4. Pull the dipstick out and look at the oil level while holding a rag under the end. If it is between the low level mark (**4**) and the full level mark (**5**), it is O.K.

NOTICE

Be careful not to drop engine oil on the vehicle components.

ENGINE



If the oil level is below or only slightly above the low mark, add engine oil of the same type as already in the engine.

Remove the oil filler cap and add engine oil a little at a time, checking the dipstick. We recommend that you use a funnel when adding oil. The approximate quantity of oil needed to fill between the low level mark and the full level mark on the dipstick is indicated below for reference.

When the level reaches within the correct range, return the filler cap and turn the cap clockwise until you hear a click.

Oil quantity. L (qt., Imp. qt.) 1.5 (1.6, 1.3)

NOTICE

- ***Be careful not to spill engine oil on the vehicle components.***
- ***Avoid overfilling, or the engine could be damaged.***
- ***Check the oil level on the dipstick once again after adding the oil.***

Engine oil selection

“Toyota Genuine Motor Oil” is used in your Lexus vehicle. Use Lexus approved “Toyota Genuine Motor Oil” or equivalent to satisfy the following grade and viscosity.

Oil grade: API grade SL “Energy-Conserving” or ILSAC multigrade engine oil.

Recommended viscosity (SAE): 5W-30

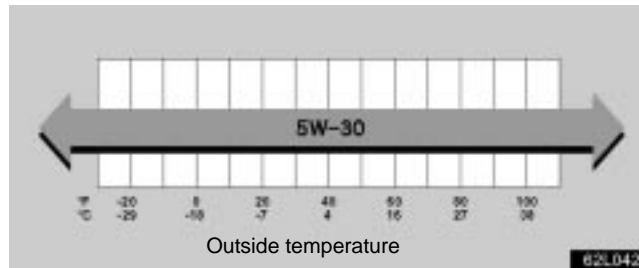

SAE 5W-30 is the best choice, for good fuel economy and good starting in cold weather.

If SAE 5W-30 is not available, SAE 10W-30 may be used. However, it should be replaced with SAE 5W-30 at the next oil change.

Oil identification marks



► **API Service Symbol**

► **ILSAC Certification Mark**

Either or both API registered marks are added to some oil containers to help you select the oil you should use.

- The API Service Symbol is located anywhere on the outside of the container.

The top portion of the label shows the oil quality by API (American Petroleum Institute) designation such as SL. The center portion of the label shows the SAE viscosity grade such as SAE 5W-30. “Energy-Conserving”, shown in the lower portion, indicates that the oil has fuel-saving capabilities.

- The ILSAC (International Lubricant Standardization and Approval Committee) Certification Mark is displayed on the front of the container.

ENGINE

To ensure excellent lubrication performance for your engine, "Toyota Genuine Motor Oil" is available, which has been specifically tested and approved for all Lexus engines.

Please contact your Lexus dealer for further details about "Toyota Genuine Motor Oil".

CHECKING THE ENGINE COOLANT LEVEL

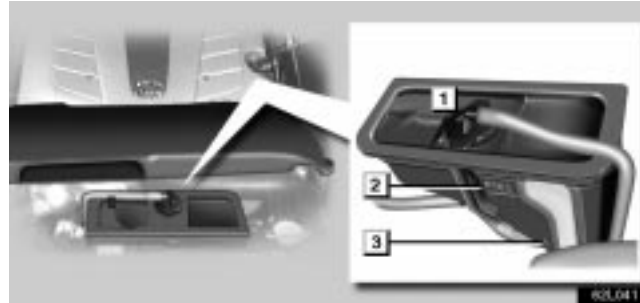

- **1** Reservoir cap **2** "FULL" (upper) line
3 "LOW" (lower) line

Look at the see-through coolant reservoir when the engine is cold. The coolant level is satisfactory if it is between the "FULL" and "LOW" lines on the reservoir. If the level is low, add the coolant. (For the coolant type, see "Coolant type selection" described below.)

The coolant level in the reservoir will vary with engine temperature. However, if the level is on or below the "LOW" line, add coolant. Bring the level up to the "FULL" line.

If the coolant level drops within a short time after replenishing, there may be a leak in the system. Visually check the radiator, hoses, engine coolant filler cap, radiator cap and drain cock and water pump.

If you can find no leak, have your Lexus dealer test the cap pressure and check for leaks in the cooling system.

 **CAUTION**

To prevent burning yourself, do not remove the radiator cap when the engine is hot.

Coolant type selection

Use of improper coolants may damage your engine cooling system.

Only use "Toyota Super Long Life Coolant" or similar high quality ethylene glycol based non-silicate, non-amine, non-nitrite, and non-borate coolant with long-life hybrid organic acid technology. (Coolant with long-life hybrid organic acid technology is a combination of low phosphates and organic acids.)

"Toyota Super Long Life Coolant" is a mixture of 50% coolant and 50% deionized water. This coolant provides protection down to about -35°C (-31°F).

NOTICE

Do not use plain water alone.

Lexus recommends "Toyota Super Long Life Coolant," which has been tested to ensure that it will not cause corrosion nor result in malfunction of your engine coolant system with proper usage. "Toyota Super Long Life Coolant" is formulated with long-life hybrid organic acid technology and has been specifically designed to avoid engine cooling system malfunction on Lexus vehicles.

Please contact your Lexus dealer for further details.

ENGINE

CHECKING THE RADIATOR AND CONDENSER

If either of the above parts are extremely dirty or you are not sure of their condition, take your vehicle to your Lexus dealer.

CAUTION

To prevent burning yourself, be careful not to touch the radiator or condenser when the engine is hot.

NOTICE

To prevent damage to the radiator and condenser, do not perform the work by yourself.

SPARK PLUGS



Your engine is fitted with iridium-tipped spark plugs.

NOTICE

Use only iridium-tipped spark plugs and do not adjust gaps for your engine performance and smooth drivability.

⋮

SECTION 6-3

SERVICE PROCEDURES AND SPECIFICATIONS

Chassis

Specifications	469
Checking brake fluid	474
Checking power steering fluid	475
Checking tire inflation pressure	476
Tire information	479
Types of tires	488
Rotating tires	489
Checking and replacing tires	490
Installing snow tires and chains	492
Replacing wheels	493
Aluminum wheel precautions	494
Suspension and chassis	495

SPECIFICATIONS

– DIFFERENTIAL

Oil capacity	1.35 L (1.42 qt., 1.19 Imp.qt.)	
Oil type and viscosity	Vehicles without synthetic oil information label	Hypoid gear oil API GL-5 Above -18°C (0°F): SAE 90 Below -18°C (0°F): SAE 80W or SAE 80W-90
	Vehicles with synthetic oil information label*	Toyota Genuine Differential Synthetic gear oil API GL-5 SAE 75W-90 or its equivalent

NOTE:

***Vehicles with synthetic oil information label only:**
The following label is affixed on the right side of the differential carrier. Use the type and viscosity shown on the label when the differential oil is replaced.

SYNTHETIC ONLY SAE 75W-90 API GL-5

Synthetic oil information label

NOTICE

Vehicles with synthetic oil information label only:
Use of differential oil other than "Toyota Genuine Differential Synthetic gear oil API GL-5 SAE 75W-90" or its equivalent may damage the differential gear of your vehicle and diminish fuel efficiency. For the reasons mentioned above, Lexus recommends use of "Toyota Genuine Differential Synthetic gear oil API GL-5 SAE 75W-90". Another differential oil of matching quality can also be used, (but note that despite the similarity in nomenclature between "Toyota Genuine Differential Synthetic gear oil API GL-5 SAE 75W-90" and oils that meet SAE 75W-90 specifications, compliance with the SAE specification does not guarantee that an oil has all characteristic required to avoid the problem described above.) If you are unable to locate an equivalent to "Toyota Genuine Differential Synthetic gear oil API GL-5 SAE 75W-90", contact your Lexus dealer for further details or another duly qualified and equipped professional.

CHASSIS

– AUTOMATIC TRANSMISSION

Fluid capacity Drain and refill	2.3 L (2.4 qt., 2.0 Imp.qt.)
Fluid type	Toyota Genuine ATF WS*

*Change automatic transmission fluid only as necessary. Generally, it is necessary to change automatic transmission fluid only if your vehicle is driven under one of the Special Operating Conditions listed in your "Owner's Manual Supplement / Scheduled Maintenance". When changing the automatic transmission fluid, use only "Toyota Genuine ATF WS" (ATF JWS 3324 or NWS 9638) to aid in assuring maximum transmission performance.

NOTICE

Using automatic transmission fluid other than "Toyota Genuine ATF WS" may cause deterioration in shift quality, locking up of your transmission accompanied by vibration, and ultimately damage the automatic transmission of your vehicle.

CHASSIS**- BRAKES**

Pedal clearance	70 mm (2.8 in.) Min. *1
Pedal free play	1 - 6 mm (0.04 - 0.24 in.)
Brake pad wear limit	1.0 mm (0.04 in.)
Parking brake lining wear limit	1.0 mm (0.04 in.)
Parking brake adjustment	5 - 7 clicks *2
Fluid type	SAE J1703 or FMVSS No. 116 DOT 3

*1Minimum pedal clearance when depressed with the pressure of 490 N (50 kgf, 110 lbf.) with the engine running

*2Parking brake adjustment when depressed with the pressure of 294 N (30 kgf, 66.1 lbf.)

- STEERING

Free play	Less than 30 mm (1.2 in.)
Power steering fluid	Automatic transmission fluid DEXRON® II or III

CHASSIS

– TIRES AND WHEELS (Type A)

Tire size	P225/55R17 95H
Tire inflation pressure Recommended cold tire inflation pressure	Front 220 kPa (2.2 kgf/cm ² or bar, 32 psi) Rear 220 kPa (2.2 kgf/cm ² or bar, 32 psi) For sustained high speeds above 160 km/h (100 mph), in countries where such speeds are permitted by law, add 20 kPa (0.2 kgf/cm ² or bar, 3 psi) to the front tires and rear tires, but never exceed the maximum cold tire inflation pressure molded on the tire sidewall.
Wheel size	17 x 7 1/2JJ
Wheel nut torque	103 N·m (10.5 kgf·m, 76 ft·lbf.)

NOTE:

For complete information on tires (e.g. replacing tires or replacing wheels), see “Checking tire inflation pressure” through “Aluminum wheel precautions” on page 476 through 494.

- TIRES AND WHEELS (Type B)

Tire size	245/45R18 96W
Tire inflation pressure Recommended cold tire inflation pressure	<p>Front 230 kPa (2.3 kgf/cm² or bar, 33 psi) Rear 230 kPa (2.3 kgf/cm² or bar, 33 psi)</p> <p>For sustained high speeds above 160 km/h (100 mph), in countries where such speeds are permitted by law, add 40 kPa (0.4 kgf/cm² or bar, 6 psi) to the front tires and rear tires, but never exceed the maximum cold tire inflation pressure molded on the tire sidewall.</p>
Wheel size	18 x 7 1/2JJ
Wheel nut torque	103 N·m (10.5 kgf·m, 76 ft·lbf.)

NOTE:

For complete information on tires (e.g. replacing tires or replacing wheels), see "Checking tire inflation pressure" through "Aluminum wheel precautions" on page 476 through 494.

CHASSIS

CHECKING BRAKE FLUID



To check the fluid level, simply look at the see-through reservoir. The level should be between the “MAX” and “MIN” lines on the tank.

It is normal for the brake fluid level to go down slightly as the brake pads wear. So be sure to keep the reservoir filled.

If the reservoir needs frequent refilling, it may indicate a serious mechanical problem.

If the level is low, add FMVSS No.116 DOT 3 or SAE J1703 brake fluid to the brake reservoir.

Remove and replace the reservoir cap by hand. Add brake fluid up to the “MAX” line.

Use only newly opened brake fluid. Once opened, brake fluid absorbs moisture from the air, and excess moisture can cause a dangerous loss of braking efficiency.

CAUTION

Take care when filling the reservoir because brake fluid can harm your hands or eyes and damage painted surfaces. If fluid gets in your eyes, flush your eyes with clean water immediately. If you still feel uncomfortable with your eyes, go to the doctor.

NOTICE

If you spill some of the fluid, be sure to wipe it off to prevent it from damaging the parts or paintwork.

CHECKING POWER STEERING FLUID



Check the fluid level on the through the reservoir. If necessary, add automatic transmission fluid DEXRON® II or III.

If the vehicle has been driven around 80 km/h (50 mph) for 20 minutes (a little more in frigid temperatures), the fluid is hot (60°C - 80°C or 140°F - 175°F). You may also check the level when the fluid is cold (about room temperature, 10°C - 30°C or 50°F - 85°F) if the engine has not been run for about five hours.

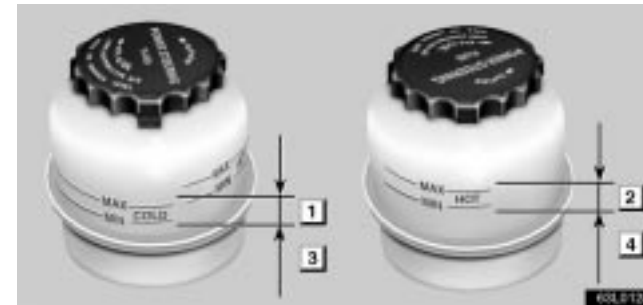

- **1** *If cold O.K.* **2** *If hot O.K.* **3** *If cold add*
4 *If hot add*

Clean all dirt off the reservoir and look at the fluid level. If the fluid is cold, the level should be in the "COLD" range. Similarly, if it is hot, the fluid level should be in the "HOT" range. If the level is at the low side of the appropriate range, add automatic transmission fluid DEXRON® II or III to bring the level within the range.

To remove the reservoir cap, turn it counterclockwise and lift up. To reinstall it, turn it clockwise. After replacing the reservoir cap, visually check the steering box case, vane pump and hose connections for leaks or damage.

CHASSIS

CAUTION

The reservoir may be hot so be careful not to burn yourself.

NOTICE

- *Avoid overfilling, or the power steering could be damaged.*
- *When adding the power steering fluid, avoid spilling it. The generator under the power steering reservoir could be damaged if fluid is spilled on it.*

CHECKING TIRE INFLATION PRESSURE



TIRE AND LOADING INFORMATION		INFORMATION SUR LES PNEUS ET LE CHARGEMENT	
SEATING CAPACITY: TOTAL X FRONT: REAR X		NOMBRE DE PLACES ASSISES: TOTAL X AVANT X: ARRIERE X	
The combined weight of occupants and cargo should never exceed 100 kg or 200 lb.		Le poids total des occupants et du chargement ne doit jamais être supérieur à 100 kg ou 200 lb.	
ORIGINAL TIRE SIZE:	COLD TIRE INFLATION PRESSURE:	DIMENSION DES PNEUS D'ORIGINE:	PRESSION DE GONFLAGE À FROID:
P XXXX/XXRXX	FRONT: (XXXPs,XXPS) REAR: (XXXPs,XXPS)	P XXXX/XXRXX	AVANT: (XXXPs,XXPS) ARRIÈRE: (XXXPs,XXPS)
SEE DRIVER'S MANUAL FOR ADDITIONAL INFORMATION		VOIR LE MANUEL DU PROPRIÉTAIRE	

The recommended cold tire inflation pressure, tire size and the combined weight of occupants and cargo (vehicle capacity weight) are described on the tire and loading information label.

You should check the tire inflation pressures every two weeks, or at least once a month. And don't forget the spare! The pressure for the spare tire should be the same as that for the standard tire. (See page 472 and 473.)

The following instructions for checking tire inflation pressure should be observed:

- **The pressure should be checked only when the tires are cold.** If your vehicle has been parked for at least 3 hours and has not been driven for more than 1.5 km or 1 mile since, you will get an accurate cold tire inflation pressure reading.
- **Always use a tire pressure gauge.** The appearance of the tire can be misleading. Besides, tire inflation pressures that are even just a few pounds off can degrade ride and handling.
- **Do not bleed or reduce tire inflation pressure after driving.** It is normal for the tire inflation pressure to be higher after driving.
- **Never exceed the vehicle capacity weight.** Passengers and luggage weight should be located so that the vehicle is balanced.

Inspection and adjustment procedure



- ▶ **1** *Tire valve*
- ▶ **2** *Tire pressure gauge*

1. Remove the tire valve cap.
2. Press the tip of the tire pressure gauge to the tire valve.
3. Read the pressure using the graduations of the gauge.
4. In case the tire inflation pressure is not within the prescribed range, insert the compressed air from the valve. In case of applying too much air, press the center of the valve and release the air to adjust.
5. After completing the tire inflation pressure measurement and adjustment, apply soapy water to the valve and check for leakage.

CHASSIS

6. Install the tire valve cap.

If a gauge and air pump are not available, have your vehicle checked by your Lexus dealer.

CAUTION

Be sure to reinstall the tire valve caps. Without the valve caps, dirt or moisture could get into the valve core and cause air leakage. If the caps have been lost, have new ones put on as soon as possible.

Incorrect tire inflation pressure may waste fuel, reduce the comfort of driving, reduce tire life and make your vehicle less safe to drive.

If a tire needs frequent refilling, have it checked by your Lexus dealer.

CAUTION

Keep your tires properly inflated. Otherwise, the following conditions may occur and cause an accident resulting in death or serious injuries.

Low tire pressure (underinflation):

- Excessive wear
- Uneven wear
- Poor handling
- Possibility of blowouts from an overheated tire
- Poor sealing of the tire bead
- Wheel deformation and/or tire separation
- A greater possibility of tire damage from road hazards

High tire pressure (overinflation):

- Poor handling
- Excessive wear
- Uneven wear
- A greater possibility of tire damage from road hazards

TIRE INFORMATION

Tire symbols



► The illustration indicates typical tire symbols.

CHASSIS

- 1 **Tire size:** For details, see “Tire size” on page 481.
- 2 **DOT and Tire Identification Number (TIN):** For details, see “DOT and Tire Identification Number (TIN)” on page 481.
- 3 **Location of tread wear indicators:** For details, see “Checking and replacing tires” on page 490.
- 4 **Tire ply composition and materials :** Plies mean a layer of rubber-coated parallel cords. Cords mean the strands forming the plies in the tire.
- 5 **Summer tire or all season tire:** An all season tire has “M+S” on the sidewall. The tire not marked with “M+S” is a summer tire. For details, see “Types of tires” on page 488.
- 6 **Radial tires or bias-ply tires:** A radial tire has “RADIAL” on the sidewall. A tire not marked with “RADIAL” is a bias-ply tire.
- 7 **“TUBELESS” or “TUBE TYPE”:** A tubeless tire does not have a tube inside the tire and air is directly filled in the tire. Tube type tire has a tube inside the tire and the tube maintains the air pressure.
- 8 **Load limit at maximum cold tire inflation pressure:** For details, see “Checking and replacing tires” on page 490.
- 9 **Maximum cold tire inflation pressure:** This means the pressure to which a tire may be inflated. For recommended cold tire inflation pressure, see “Tires and wheels” on page 472.
- 10 **Uniform tire quality grading:** For details, see “Uniform tire quality grading “ on page 483.

DOT and Tire Identification Number (TIN)

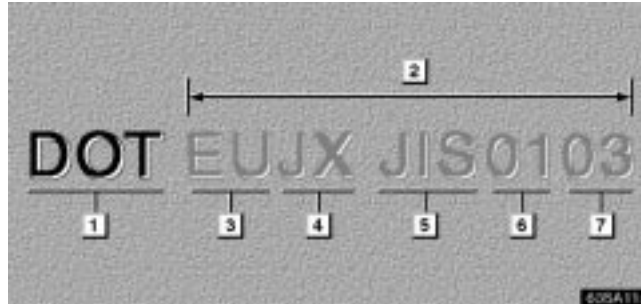

► The illustration indicates typical DOT and Tire Identification Number (TIN)

- 1 "DOT" symbol
- 2 Tire Identification Number (TIN)
- 3 Tire manufacturer's identification mark
- 4 Tire size code
- 5 Manufacturer's optional tire type code
- 6 Manufacturing week
- 7 Manufacturing year

The "DOT" symbol certifies that the tire conforms to applicable Federal Motor Vehicle Safety Standards.

Tire size

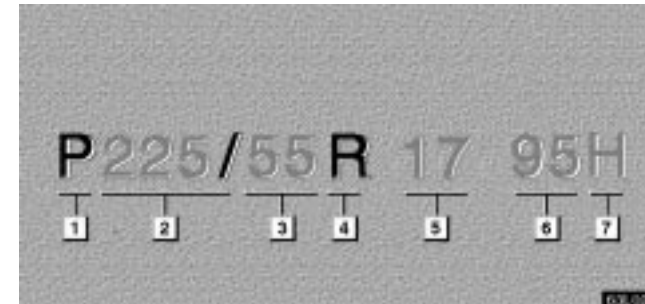

► The illustration indicates typical tire size.

- 1 Tire use (P=Passenger car, T=Temporary use)
- 2 Section width (in millimeters)
- 3 Aspect ratio (tire height to section width)
- 4 Tire construction code (R=Radial, D=Diagonal)
- 5 Wheel diameter (in inches)
- 6 Load index (2 digits or 3 digits)
- 7 Speed symbol (alphabet with one letter)

CHASSIS



- ▶ **1** Section width
- ▶ **2** Tire height
- ▶ **3** Wheel diameter

Name of each section of tire

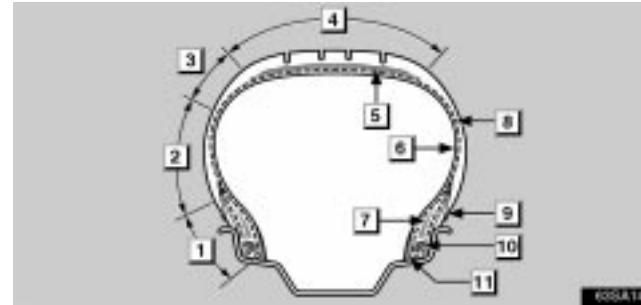

- ▶ **1** Bead
- ▶ **2** Sidewall
- ▶ **3** Shoulder
- ▶ **4** Tread
- ▶ **5** Belt
- ▶ **6** Inner liner
- ▶ **7** Reinforcing rubber
- ▶ **8** Carcass
- ▶ **9** Rim lines
- ▶ **10** Bead wires
- ▶ **11** Chafer

Uniform tire quality grading

This information has been prepared in accordance with regulations issued by the National Highway Traffic Safety Administration of the U.S. Department of Transportation. It provides the purchasers and/or prospective purchasers of Lexus vehicles with information on uniform tire quality grading.

Your Lexus dealer will help answer any questions you may have as you read this information.

DOT quality grades - All passenger vehicle tires must conform to Federal Safety Requirements in addition to these grades. Quality grades can be found where applicable on the tire sidewall between tread shoulder and maximum section width. For example: Treadwear 200 Traction AA Temperature A

Treadwear - The treadwear grade is a comparative rating based on the wear rate of the tire when tested under controlled conditions on a specified government test course. For example, a tire graded 150 would wear one and a half (1 - 1/2) times as well on the government course as a tire graded 100. The relative performance of tires depends upon the actual conditions of their use, however, and may depart significantly from the norm due to variations in driving habits, service practices and differences in road characteristics and climate.

Traction AA, A, B, C - The traction grades, from highest to lowest, are AA, A, B and C, and they represent the tire's ability to stop on wet pavement as measured under controlled conditions on specified government test surfaces of asphalt and concrete. A tire marked C may have poor traction performance.

Warning: The traction grade assigned to this tire is based on braking (straight ahead) traction tests and does not include cornering (turning) traction.

Temperature A, B, C - The temperature grades are A (the highest), B, and C, representing the tire's resistance to the generation of heat and its ability to dissipate heat when tested under controlled conditions on a specified indoor laboratory test wheel. Sustained high temperature can cause the material of the tire to degenerate and reduce tire life, and excessive temperature can lead to sudden tire failure. The grade C corresponds to a level of performance which all passenger car tires must meet under the Federal Motor Vehicle Safety Standard No. 109. Grades B and A represent higher levels of performance on the laboratory test wheel than the minimum required by law.

Warning: The temperature grades for this tire are established for a tire that is properly inflated and not overloaded. Excessive speed, underinflation, or excessive loading, either separately or in combination, can cause heat buildup and possible tire failure.

CHASSIS

Glossary of tire terminology

Tire related term	Meaning
Accessory weight	the combined weight (in excess of those standard items which may be replaced) of automatic transmission, power steering, power brakes, power windows, power seats, radio, and heater, to the extent that these items are available as factory-installed equipment (whether installed or not)
Cold tire inflation pressure	tire pressure when the vehicle has been parked for at least 3 hours or more, or it has not been driven more than 1.5 km or 1 mile under that condition.
Curb weight	the weight of a motor vehicle with standard equipment including the maximum capacity of fuel, oil, and coolant, and, if so equipped, air conditioning and additional weight optional engine
Intended outboard sidewall	(a) the sidewall that contains a whitewall, bears white lettering or bears manufacturer, brand, and/or model name molding that is higher or deeper than the same molding on the other sidewall of the tire, or (b) the outward facing sidewall of an asymmetrical tire that has a particular side that must always face outward when mounted on a vehicle.
Maximum inflation pressure	the maximum cold inflation pressure to which a tire may be inflated and it is shown on the sidewall of the tire

CHASSIS

Tire related term	Meaning
Maximum loaded vehicle weight	the sum of — (a) curb weight; (b) accessory weight; (c) vehicle capacity weight; and (d) production options weight
Normal occupant weight	68 kg (150 lb.) times the number of occupants specified in the second column of Table 1 that follows.
Occupant distribution	distribution of occupants in a vehicle as specified in the third column of Table 1 that follows.
Production options weight	the combined weight of those installed regular production options weighing over 2.3 kg (5 lb.) in excess of those standard items which they replace, not previously considered in curb weight or accessory weight, including heavy duty brakes, ride levelers, roof rack, heavy duty battery, and special trim
Recommended inflation pressure	cold tire inflation pressure recommended by a manufacturer
Rim	a metal support for a tire or a tire and tube assembly upon which the tire beads are seated

CHASSIS

Tire related term	Meaning
Rim diameter (Wheel diameter)	nominal diameter of the bead seat
Rim size designation	rim diameter and width
Rim type designation	the industry of manufacturer's designation for a rim by style or code
Rim width	nominal distance between rim flanges
Vehicle capacity weight (Total load capacity)	the rated cargo and luggage load plus 68 kg (150 lb.) times the vehicle's designated seating capacity
Vehicle maximum load on the tire	the load on an individual tire that is determined by distributing to each axle its share of the maximum loaded vehicle weight and dividing by two
Vehicle normal load on the tire	the load on an individual tire that is determined by distributing to each axle its share of the curb weight, accessory weight, and normal occupant weight (distributed in accordance with Table 1 that follows) and dividing by two
Weather side	the surface area of the rim not covered by the inflated tire

Table 1 – Occupant loading and distribution for vehicle normal load for various designated seating capacities

CHASSIS

Designated seating capacity, Number of occupants	Vehicle normal load, Number of occupants	Occupant distribution in a normally loaded vehicle
2 through 4	2	2 in front
5 through 10	3	2 in front, 1 in second seat

CHASSIS

TYPES OF TIRES

Determine what kind of tires your vehicle is originally equipped with.

1. All season tires

All season tires are designed to provide better traction in snow and to be adequate for driving in most winter conditions, as well as for use all year round.

All season tires, however, do not have adequate traction performance compared with snow tires in heavy or loose snow. Also, all season tires fall short in acceleration and handling performance compared with summer tires in highway driving.

2. Summer tires

Summer tires are high-speed capability tires best suited to highway driving under dry conditions.

Since summer tires do not have the same traction performance as snow tires, summer tires are inadequate for driving on snow-covered or icy roads. For driving on snow-covered or icy roads, we recommend using snow tires. If installing snow tires, be sure to replace all four tires.

CAUTION

- Do not mix all season and summer tires on your vehicle as this can cause dangerous handling characteristics, resulting in loss of control.
- Do not use tires other than the manufacturer's designated tires, and never mix tires or wheels of the sizes different from the originals, as this could result in loss of control and could cause death or serious injury.

ROTATING TIRES

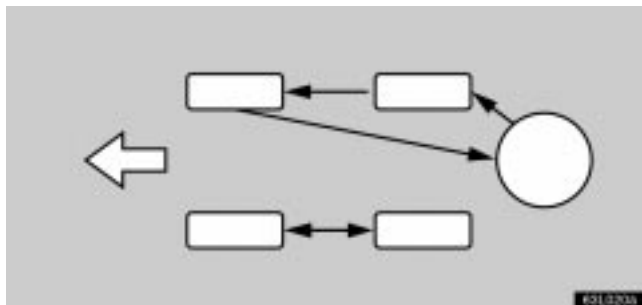

To equalize tire wear and help extend tire life, Lexus recommends that you rotate your tires according to the maintenance schedule. (For scheduled maintenance information, please refer to the “Owner’s Manual Supplement / Scheduled Maintenance”.) However, the most appropriate timing for tire rotation may vary according to your driving habits and road surface conditions.

The wheel assemblies must be rotated as illustrated above.

When rotating tires, check for uneven wear and damage. Abnormal wear is usually caused by incorrect tire inflation pressure, improper wheel alignment, out-of-balance wheels, or severe braking.

Before storing radial, snow or studded tires, mark the direction of rotation and be sure to install them in the same direction when using them again. Tires should be stored in a cool dry place.

Initial adjustment of the tire pressure warning system is necessary after you have rotated your tires. See “Tire pressure warning system” on page 365.

CHECKING AND REPLACING TIRES

When to replace your tires



- ▶ **1** *New tread* **2** *Tread wear indicator*
- 3** *Worn tread*

Replace the tires when the tread wear indicators show. The location of the tread wear indicators is shown by the “TWI” or “△” marks, etc., molded on the sidewall of each tire.

The tires on your Lexus have built-in tread wear indicators to help you know when the tires need replacement. When the tread depth wears to 1.6 mm (0.06 in.) or less, the indicators will appear. If you can see the indicators in two or more adjacent grooves, the tire should be replaced.

The effectiveness of snow tires is lost if the tread wears down below 4 mm (0.16 in.).

If you have tire damage such as cuts, splits, cracks deep enough to expose the fabric, or bulges indicating internal damage, the tire should be replaced.

If a tire often goes flat or cannot be properly repaired due to the size or location of a cut or other damage, it should be replaced. If you are not sure, consult with your Lexus dealer.

If air loss occurs while driving, do not continue driving. Driving even a short distance can damage a tire beyond repair.

Any tires which are over 6 years old must be checked by a qualified technician even if damage is not obvious.

Tires deteriorate with age even if they have never or seldom been used.

This applies also to the spare tire and tires stored for future use.

Tire selection

When replacing a tire, use a tire of the same size and construction, and the same or greater maximum load as the originally installed tires.

Using any other size or type of tire may seriously affect handling, ride, speedometer/odometer calibration, ground clearance, and clearance between the body and tires or snow chains.

Check that the maximum load of the replaced tire is greater than 1/2 of the Gross Axle Weight Ratings (GAWR) of either the front axle or the rear axle, whichever is greater. As for the maximum load of the tire, see the load limit at maximum cold tire inflation pressure mentioned on the sidewall of the tire, and as for the Gross Axle Weight Ratings (GAWR), see the Certification Label. For details about the Certification Label and sidewall of the tire, see pages 443 and 479.



CAUTION

Observe the following instructions. Otherwise, an accident may occur resulting in death or serious injuries.

- **Do not mix radial, bias belted, or bias-ply tires on your vehicle, as this may cause dangerous handling characteristics resulting in loss of control.**
- **Do not use tires other than the manufacturer's recommended size, as this may cause dangerous handling characteristics resulting in loss of control.**

If you need to change from conventional tires to radial tires or vice versa, replace them as a set.

CHASSIS

INSTALLING SNOW TIRES AND CHAINS

When to use snow tires or chains

Snow tires or chains are recommended when driving on snow or ice.

On wet or dry roads, conventional or radial tires provide better traction than snow or studded tires.

Snow tire selection

If you need snow tires, select tires of the same size, construction and load capacity as the originally installed tires.

Do not use tires other than stated above. Since your vehicle has radial tires as original equipment, make sure your snow tires also have radial construction. Do not install studded tires without first checking local regulations for possible restrictions.



CAUTION

Observe the following instruction. Otherwise, an accident may occur resulting in death or serious injuries.

- **Do not use snow tires other than the manufacturer's recommended size, as this may cause dangerous handling characteristics resulting in loss of control.**

Snow tire installation

Snow tires should be installed on all wheels.

Installing snow tires on the rear wheels only can lead to an excessive difference in road grip capability between the front and rear tires which could cause loss of vehicle control.



CAUTION

- **Do not drive with the snow tires incorrectly inflated.**
- **Never drive over 120 km/h (75 mph) with any type of snow tires.**

Tire chain selection

Regulations regarding the use of tire chains vary according to location or type of road. Always check local regulations before installing chains.

Use SAE Class "S" type radial tire chains, with the exception of radial cable chains or V-bar type chains.

Chain installation

Install the chains on the rear tires as tightly as possible. Do not use tire chains on the front tires. Retighten chains after driving 0.5 - 1.0 km (1/4 - 1/2 mile).

When installing chains on your tires, carefully follow the instructions of the chain manufacturer.

 CAUTION	
<ul style="list-style-type: none">• Do not exceed 50 km/h (30 mph) or the chain manufacturer's recommended speed limit, whichever is lower.• Drive carefully avoiding bumps, holes, and sharp turns, which may cause the vehicle to bounce.• Avoid sharp turns or locked-wheel braking, as use of chains may adversely affect vehicle handling.• When driving with chains installed, be sure to drive carefully. Slow down before entering curves to avoid losing control of the vehicle. Otherwise an accident may occur.	

If the chains are installed, the tire pressure warning system may not operate properly. See "Tire pressure warning system" on page 365.

REPLACING WHEELS

When to replace your wheels

If you have wheel damage such as bending, cracks or heavy corrosion, the wheel should be replaced.

If you fail to replace a damaged wheel, the tire may slip off the wheel or cause loss of handling control.

Wheel selection

When replacing wheels, care should be taken to ensure that they are equivalent to those removed in load capacity, diameter, rim width, and offset.

Correct replacement wheels are available at your Lexus dealer.

A wheel of a different size or type may adversely affect handling, wheel and bearing life, brake cooling, speedometer/odometer calibration, stopping ability, headlight aim, bumper height, vehicle ground clearance, and tire or snow chain clearance to the body and chassis.

Replacement with used wheels is not recommended as they may have been subjected to rough treatment or high mileage and could fail without warning. Also, bent wheels which have been straightened may have hidden structural damage and therefore should not be used. Never use an inner tube in a leaking wheel which is designed for a tubeless tire.

CHASSIS



CAUTION

Observe the following instruction. Otherwise, an accident may occur resulting in death or serious injuries.

- Do not use wheels other than the manufacturer's recommended size, as this may cause dangerous handling characteristics resulting in loss of control.

Initial adjustment of the tire pressure warning system is necessary after you have replaced your wheels. See "Tire pressure warning system" on page 365.

ALUMINUM WHEEL PRECAUTIONS

- When installing aluminum wheels, check that the wheel nuts are tight after driving your vehicle the first 1600 km (1000 miles).
- If you have rotated, repaired, or changed your tires, check that the wheel nuts are still tight after driving 1600 km (1000 miles).
- When using tire chains, be careful not to damage the aluminum wheels.
- Use only Lexus wheel nuts and wrench designed for your aluminum wheels.
- When balancing your wheels, use only Lexus balance weights or equivalent and a plastic or rubber hammer.
- As with any wheel, periodically check your aluminum wheels for damage. If damaged, replace immediately.

SUSPENSION AND CHASSIS

 **CAUTION**

Do not modify the suspension/chassis with lift kits, spacers, springs, etc. It can cause dangerous handling characteristics, resulting in loss of control.

SECTION 6-4

SERVICE PROCEDURES AND SPECIFICATIONS

Electrical components

Specifications	498
Checking battery condition	505
Battery recharging precautions	508
Checking and replacing the blade type fuses	508
Checking the cartridge type fuses	511
Adding washer fluid	512
Checking the headlight aim	513
Replacing light bulbs	514

ELECTRICAL COMPONENTS

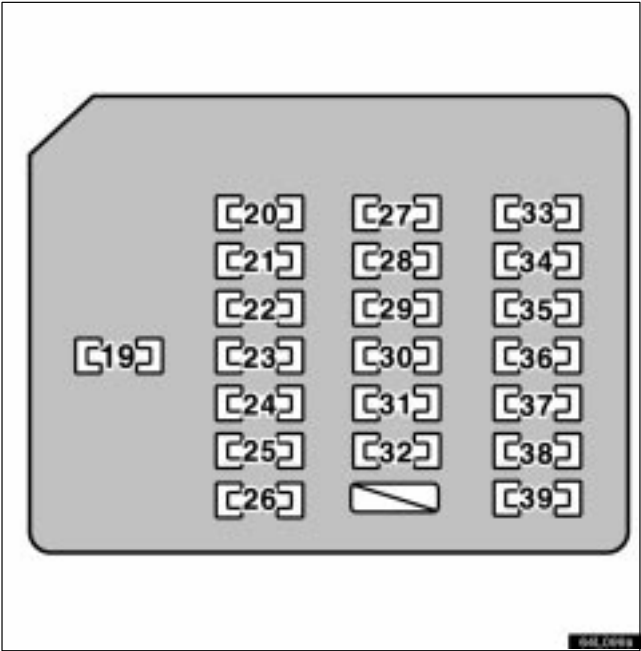

► Passenger's side kick panel

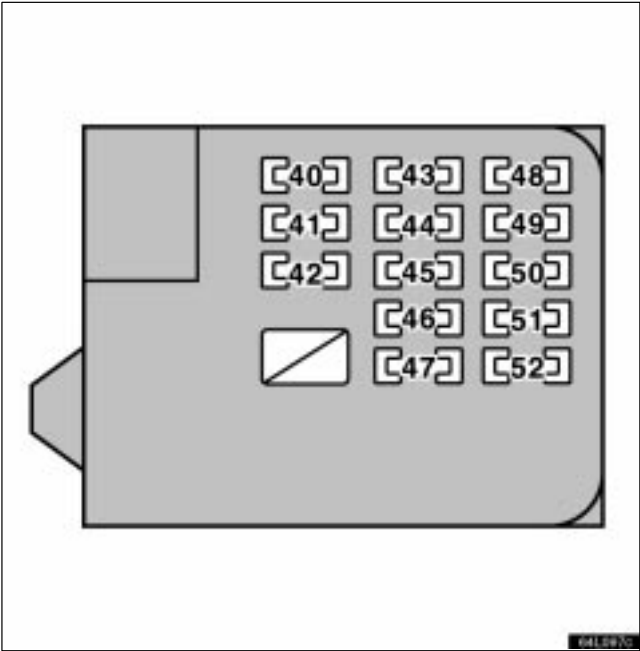

► Trunk

ELECTRICAL COMPONENTS

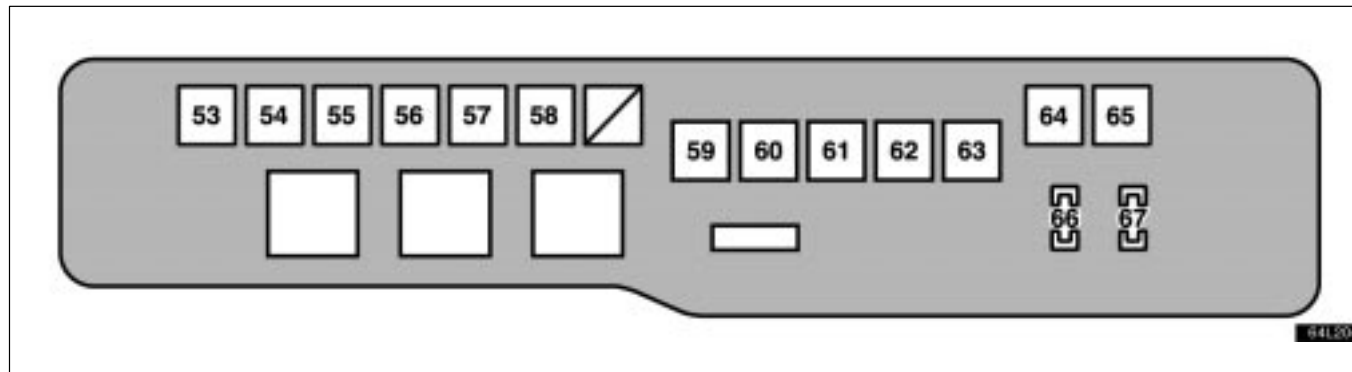

► *Engine compartment (with electronically modulated air suspension)*

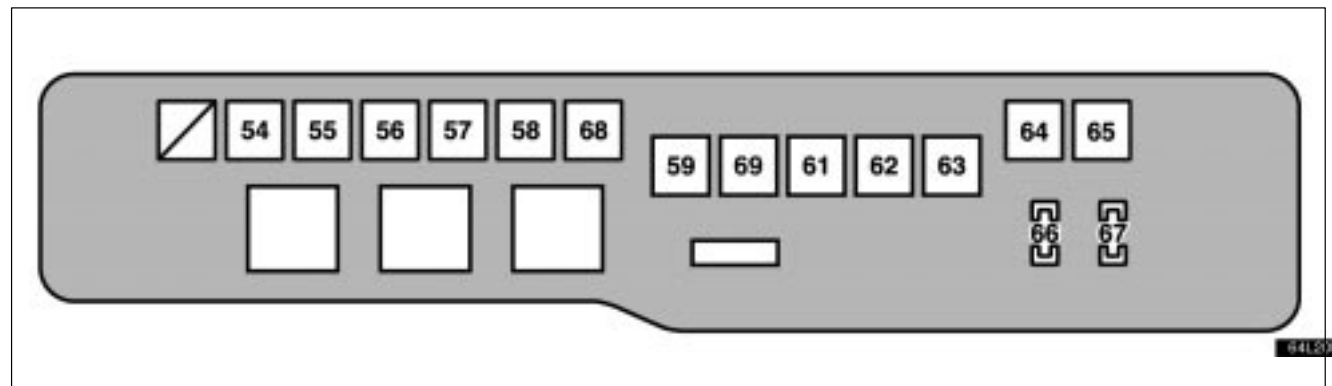

► *Engine compartment (without electronically modulated air suspension)*

ELECTRICAL COMPONENTS

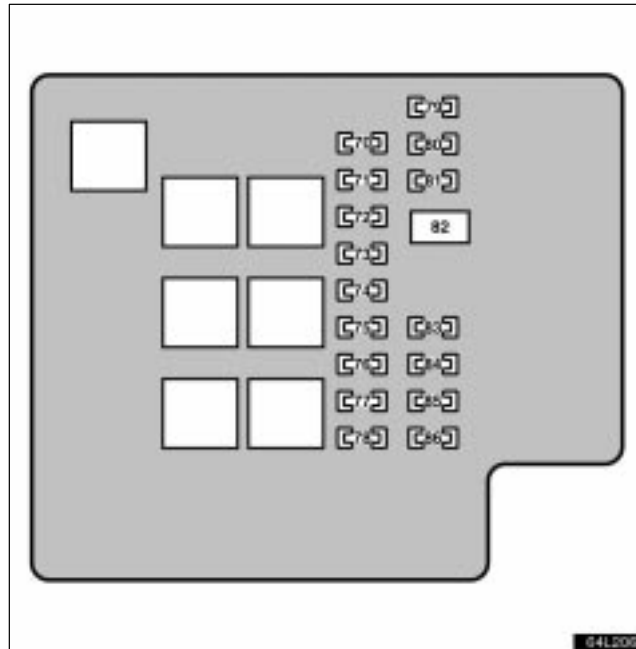

► *Engine compartment*

No.	FUSE	AMPERE	CIRCUIT
1	TI & TE	20	Tilt and telescopic steering
2	PANEL	7.5	Lexus park assist system, Rear seat heater, Rear climate control seat, Multi-information display, Audio system, Cigarette lighter, Instrument panel light, Coin box light, Rear mirror light, Glove box light, Power rear seat, Electronically modulated air suspension system, Turn signal lights, Clock, Shift lock system, Vehicle stability control system, Sunshade, Power rear view mirror control system, Console box light, Fuel opener system, Adaptive front-lighting system
3	D P/SEAT	30	Power seat system
4	GAUGE	7.5	Gauges and meters, Lexus park assist system, Shift lock system
5	MPX-IG	7.5	Tilt and telescopic steering, Power door lock system, Power seat system, Engine immobilizer system
6	D S/HTR	15	Seat heater, Climate control seat system
7	AIR SUS	20	Electronically modulated air suspension system
8	D-ACC	7.5	Shift lock system, Theft deterrent system

ELECTRICAL COMPONENTS

No.	FUSE	AMPERE	CIRCUIT
9	PWR OUTLET	15	Power outlet
10	D-CIG	15	Rear cigarette lighter
11	OBD	7.5	On-board diagnosis system
12	AM1	7.5	Starting system
13	ABS-IG	7.5	Vehicle stability control system
14	D B/ANC	5	Seat belts
15	SECURITY	7.5	Theft deterrent system
16	A/C	7.5	Air conditioning system
17	STOP	5	Stop lights
18	D RR-IG	10	Refreshing seat
19	IG2	30	SRS airbag system, Engine immobilizer system, Steering lock system, Starting system
20	HAZ	15	Emergency flashers
21	STR LOCK	7.5	Steering lock system
22	AM2	7.5	All components in "STA" and "IG2", Starting system
23	MPX-B1	7.5	Power door lock system, Engine immobilizer system, Steering lock system, Front power seat, Rear power seat
24	MPX-B3	7.5	Tilt and telescopic steering, Headlight switch, Windshield wiper and washer switch, Turn signal switch

No.	FUSE	AMPERE	CIRCUIT
25	DOME	10	Vanity lights, Outer foot lights, Ignition switch light, Clock, Gauges and meters, Interior lights, Personal lights
26	MPX-B2	7.5	Gauges and meters, Vehicle stability control system, Illuminated entry system, TEL
27	P RR-IG	10	Refreshing seat
28	H-LP LVL	7.5	Headlight leveling system, Adaptive front-lighting system
29	P-IG	7.5	Rain sensor, Air conditioning system, Moon roof, Multi-information display, Clock
30	P S/HTR	15	Seat heater, Climate control seat system
31	P-ACC	7.5	Air conditioning system, Audio system, Clock, Multi-information display, Illuminated entry system
32	P-CIG	15	Front cigarette lighter
33	RADIO NO.1	7.5	Audio system
34	RR DOOR LH	20	Power door lock system, Power window, Door closer system, Door courtesy lights

ELECTRICAL COMPONENTS

No.	FUSE	AMPERE	CIRCUIT
35	P DOOR	25	Power door lock system, Power rear view mirror control system, Outside rear view mirror defogger, Door closer system, Door courtesy lights, Power windows
36	TEL	7.5	Audio system, Navigation system
37	P B/ANC	5	Seat belts, Seat belt buckle illumination
38	RR DOOR RH	20	Power door lock system, Power window, Door closer system, Door courtesy lights
39	D DOOR	25	Power door lock system, Door closer system, Power rear view mirror control system, Outside rear view mirror defogger, Door courtesy lights, Power windows
40	RR IG	7.5	Lexus park assist system, Electronically modulated air suspension system, Theft deterrent system, TEL
41	RR ACC	7.5	Audio system, TEL
42	RR ECU-B	7.5	Rear air conditioning system, Theft deterrent system, Trunk light, Refreshing rear seat
43	RR A/C	7.5	Rear air conditioning system, Air purifier
44	RR S/HTR	30	Seat heater, Climate control seat system

No.	FUSE	AMPERE	CIRCUIT
45	RR S/SHADE	15	Sunshade
46	LCE LP	7.5	License plate lights
47	S/ROOF	30	Moon roof
48	FUEL OPN	10	Fuel opener system, Trunk lid closer system
49	AMP	30	Audio system
50	P P/SEAT	30	Power seat system
51	RR SEAT LH	30	Power seat system
52	RR SEAT RH	30	Power seat system
53	LUG J/B	50	All components in "RR SEAT RH", "RR SEAT LH", "S/ROOF", "AMP", "RR IG", "RR ECU-B", "P P/SEAT", "RR S/HTR", "RR S/SHADE", "RR A/C", "RR ACC", "FUEL OPN" and "LCE LP", Tail lights and Stop lights
54	ABS 2	50	Vehicle stability control system
55	HEATER	50	Air conditioning system
56	ABS 1	30	Vehicle stability control system
57	DEFOG	40	Rear window defogger
58	AIR SUS	40	Electronically modulated air suspension system

ELECTRICAL COMPONENTS

No.	FUSE	AMPERE	CIRCUIT
59	R/B	60	All components in "FR FOG", "TAIL", "WASHER", "FR IG", "WIP", "H-LP CRN" and "A/C IG"
60	FAN	80	Air conditioning system
61	D-J/B	80	All components in "TI & TE", "D P/SEAT", "A/C", "OBD", "STOP", "AM1", "MPX-IG", "ABS-IG", "GAUGE", "AIRSUS", "D S/HTR", "SECURITY", "PANEL", "D B/ANC", "PWR OUTLET", "D-CIG", "D RR-IG" and "D-ACC"
62	ALT	140	Charging system
63	P-J/B	80	All components in "RR DOOR RH", "RR DOOR LH", "D DOOR", "H-LP LVL", "P DOOR", "P S/HTR", "P-IG", "P-ACC", "P B/ANC", "P-CIG", "TEL" and "P RR-IG"
64	BATT	30	All components in "RADIO NO.1", "AM2", "HAZ" and "STR LOCK"
65	ST	30	Starting system
66	D/C CUT	20	All components in "DOME", "MPX-B1", "MPX-B2" and "MPS-B3"
67	ALT-S	5	Charging system
68	FAN	50	Air conditioning system

No.	FUSE	AMPERE	CIRCUIT
69	LUG J/B	60	All components in "RR SEAT RH", "RR SEAT LH", "S/ROOF", "AMP", "RR IG", "RR ECU-B", "P P/SEAT", "RR S/HTR", "RR S/SHADE", "RR A/C", "RR ACC", "FUEL OPN" and "LCE LP", Tail lights and Stop lights
70	H-LP R LWR	15	Right-hand headlight (low beam)
71	H-LP L LWR	15	Left-hand headlight (low beam)
72	EFI NO.2	7.5	Multiport fuel injection system/sequential multiport fuel injection system
73	STA	7.5	Multiport fuel injection system/sequential multiport fuel injection system
74	INJ	10	Multiport fuel injection system/sequential multiport fuel injection system
75	IGN	7.5	Multiport fuel injection system/sequential multiport fuel injection system
76	FR IG	7.5	Electric cooling fan, Headlight cleaner, Charging system, Starting system, Rear window defogger
77	A/C IG	7.5	Air conditioning system
78	WIP	30	Windshield wiper

No.	FUSE	AMPERE	CIRCUIT
79	FR FOG	15	Fog lights
80	WASHER	20	Windshield washer
81	TAIL	7.5	Tail lights, Parking lights, Side marker lights
82	H-LP CLN	30	Headlight cleaner
83	EFI NO.1	25	Multiport fuel injection system/sequential multiport fuel injection system
84	HORN	10	Horns
85	ETCS	10	Multiport fuel injection system/sequential multiport fuel injection system
86	H-LP HI	20	Headlights (high beam)

CHECKING BATTERY CONDITION

Precautions



CAUTION

BATTERY PRECAUTIONS

The battery produces flammable and explosive hydrogen gas.

- Do not cause a spark by contacting the battery terminals with tools.
- Do not smoke or light a match near the battery.

The electrolyte contains poisonous and corrosive sulfuric acid.

- Avoid contact with eyes, skin or clothes.
- Never inhale or swallow electrolyte.
- Wear protective safety glasses when working near the battery.
- Keep children away from the battery.

EMERGENCY MEASURES

- If electrolyte gets in your eyes, flush your eyes with clean water for at least 15 minutes and get immediate medical attention. If possible, continue to apply water with a sponge or cloth while traveling to the medical office.

ELECTRICAL COMPONENTS

- If electrolyte gets on your skin, thoroughly wash the contacted area. If you feel a pain or burn, get medical attention immediately.
- If electrolyte gets on your clothes, there is a possibility of its soaking through to your skin, so immediately take off the exposed clothing and follow the procedure above, if necessary.
- If you accidentally swallow electrolyte, drink a large quantity of water or milk. Follow with milk of magnesia, beaten raw egg or vegetable oil. Then go immediately for emergency help.
- **Warning:** Battery posts, terminals and related accessories contain lead and lead compounds, chemicals known to the State of California to cause cancer and reproductive harm. Wash hands after handling.

Checking battery exterior



► **1** Terminals **2** Hold-down clamp

Check the battery for corroded or loose connections, cracks, or loose hold-down clamps.

1. If the battery is corroded, wash it off with a solution of warm water and baking soda. Coat the terminals with grease to prevent further corrosion.
2. If the connections are loose, tighten the clamp bolts - but do not overtighten.
3. Tighten the hold-down clamp only enough to keep the battery firmly in place. Overtightening may damage the battery case.

NOTICE

- *Make sure the engine and all accessories are turned off before performing maintenance.*
- *When checking the battery, remove the ground cable first and reinstall it last.*
- *Be careful not to cause a short circuit with tools.*
- *Take care no solution gets into the battery when washing it.*

Checking battery condition

Checking by indicator

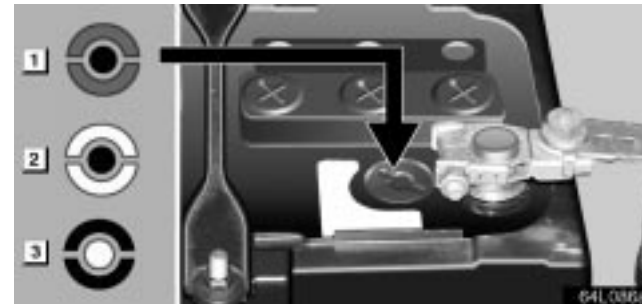

Check the battery condition by the indicator color.

- 1 BLUE - Good condition.
- 2 WHITE - Charging necessary. Have the battery checked by your Lexus dealer.
- 3 RED - Have the battery checked by your Lexus dealer.

NOTICE

Do not refill the battery with water.

ELECTRICAL COMPONENTS

BATTERY RECHARGING PRECAUTIONS

During recharging, the battery is producing hydrogen gas.

Therefore, before recharging:

1. If recharging with the battery installed on the vehicle, be sure to disconnect the ground cable.
2. Make sure the power switch on the recharger is off when connecting the charger cables to the battery and when disconnecting them.



CAUTION

- Always charge the battery in an unconfined area. Do not charge the battery in a garage or closed room where there is not sufficient ventilation.
- Only do a slow charge (5 A or less). Charging at a quicker rate is dangerous. The battery may explode causing personal injuries.

NOTICE

Never recharge the battery while the engine is running. Also, make sure all accessories are turned off.

CHECKING AND REPLACING THE BLADE TYPE FUSES



► Engine compartment 1 Spare fuses 2 Pull-out tool



► Engine compartment

ELECTRICAL COMPONENTS



► *Driver's side kick panel*



► *Passenger's side kick panel*



► *Trunk*

1. Turn the ignition switch off and open the fuse box lid.

Determine which fuse may be causing the problem. The lid of the fuse box shows the name of the circuit for each fuse.

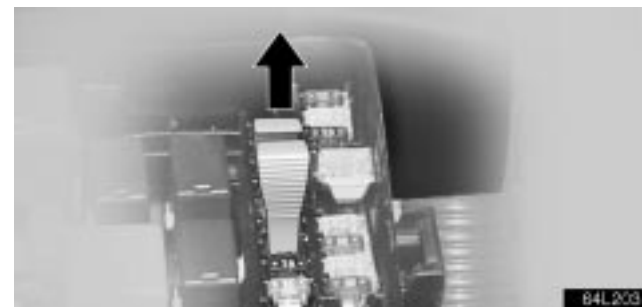

2. Make sure the inoperative component is turned off. Pull the suspected fuse straight out with the pull-out tool and check it. If it has blown, push a new fuse into the clips.

ELECTRICAL COMPONENTS

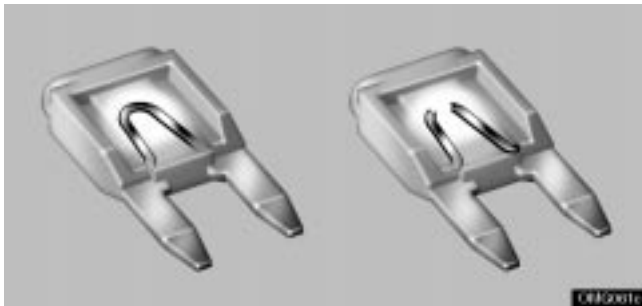

► **Good**

► **Blown**

a. Look carefully at the fuse. If the thin wire is broken, the fuse has blown. If you are not sure or if it is too dark to see, try replacing the suspected fuse with one of the same value that you know is good.

b. Only install a fuse with the amperage rating designated on the fuse box lid.

If you do not have a spare fuse, in an emergency you can pull out the "D-CIG" "P RR-IG" or "OBD" fuse, which may be dispensable for normal driving, and use it if its amperage rating is the same.

If you cannot use one of the same amperage, use one lower than, but as close to the amperage as possible. If the amperage is lower than that specified, the fuse might blow out again but this does not indicate anything wrong. Be sure to get the correct fuse as soon as possible and return the substitute to its original clips.

It is a good idea to purchase a set of spare fuses and keep them in your vehicle for emergencies.

If the new fuse immediately blows out, there is a problem with the electrical system. Have your Lexus dealer correct it as soon as possible.

 **CAUTION**

Never use a fuse with a higher amperage rating, or any other object, in place of a fuse. This may cause extensive damage and possibly a fire.

CHECKING THE CARTRIDGE TYPE FUSES



► *Engine compartment*



► *Engine compartment*

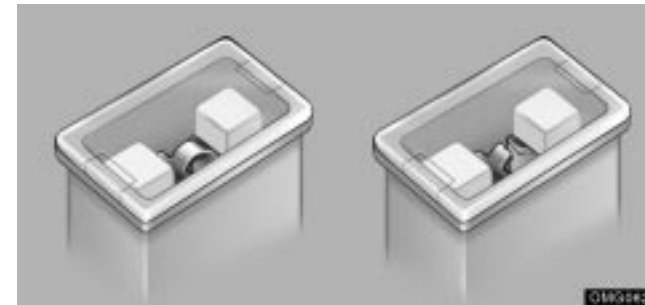

► *Good*

► *Blown*

If the headlights or other electrical components do not work and the blade type fuses are O.K., check the cartridge type fuses. If any of the cartridge type fuses are blown, they must be replaced.

If there is an overload in the circuits from the battery, the fuses are designed to blow before the entire wiring harness is damaged.

CAUTION

Always use a genuine Lexus fuse or equivalent for replacement. Never install an ordinary wire-even for a temporary fix. This may cause extensive damage and possibly a fire.

ELECTRICAL COMPONENTS

NOTICE

Before replacing the fuses, have the cause of electrical overload determined and repaired by your Lexus dealer.

ADDING WASHER FLUID



If the washer tank becomes nearly empty, add washer fluid.

You may use plain water as washer fluid. However, in cold areas where temperatures range below the freezing point, use washer fluid containing antifreeze. This product is available at your Lexus dealer and most auto parts stores. Follow the manufacturer's directions for how much to mix with water.

NOTICE

Do not use engine antifreeze or any other substitute because it may damage your vehicle's paint.

CHECKING THE HEADLIGHT AIM



- ▶ **1** *Vertical movement adjusting bolt 1*
- 2** *Vertical movement adjusting bolt 2*

Before checking the headlight aim:

1. Be sure that the body around the headlight is not deformed.
2. Park the vehicle on a level spot.
3. Get into the driver's seat and put the vehicle in a state ready for driving (with a full tank).
4. Bounce the vehicle several times.

Adjusting the vertical aiming



1. Turn the vertical movement adjusting bolt 1 in either direction using a Phillips-head screwdriver. At this time, keep the turning direction and number of turns in mind.

ELECTRICAL COMPONENTS



2. Turn the vertical movement adjusting bolt 2 the same number of turns and in the same direction as step 1 using a Phillips-head screwdriver.

REPLACING LIGHT BULBS

The illustrations on the following pages show the locations of light bulbs. If it is necessary to replace a bulb, take your vehicle to your Lexus dealer as soon as possible. Use bulbs with the bulb numbers and wattage ratings given in the table.

CAUTION

- To prevent burning yourself, do not replace the light bulbs while they are hot.
- Halogen bulbs have pressurized gas inside and require special handling. They can burst or shatter if scratched or dropped. Hold a bulb only by its plastic or metal case. Do not touch the glass part of a bulb with bare hands.
- Do not touch the high voltage socket when the headlights turn on. 20000 V is momentarily generated and may cause severe injury by an electric shock.
- Do not disassemble, repair or take apart the headlight bulbs, connector, power supply circuits and rotated components. Or you may be injured by electric shocks. Call your dealer when the headlights fail to work or have to be replaced or disposed of.

NOTICE

Only use a bulb of the listed type.

ELECTRICAL COMPONENTS

The inside of the lens of exterior lights such as headlights may temporarily fog up when the lens becomes wet in the rain or in a car wash. This is not a problem because the fogging is caused by the temperature difference between the outside and inside of the lens, just like the windshield fogs up in the rain. However, if there is a large drop of water on the inside of the lens, or if there is water pooled inside the light, contact your Lexus dealer.

LIGHT LOCATION



	Light Bulbs	Bulb No.	W	Type
1	Headlight (High beam)	9005	60	A
2	Parking light	---	5	D
3	Headlight (Low beam)	---	35	B
4	Front turn signal light	---	21	D
5	Front side marker light	---	5	D
6	Fog light	9006	51	C

ELECTRICAL COMPONENTS



Light Bulbs	Bulb No.	W	Type
1 High mounted stoplight	---	21	D
2 Trunk light	194	3.8	D
3 License plate light	---	5	D
4 Back-up light	921	18	D
5 Rear turn signal light	---	21	D

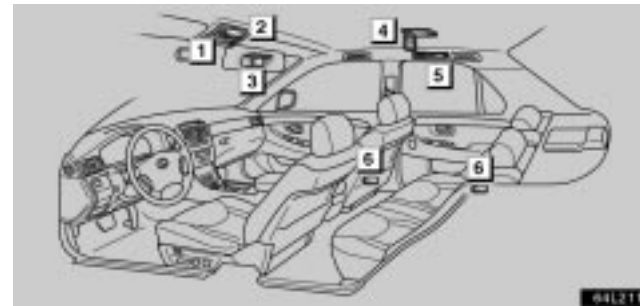

Light Bulbs	Bulb No.	W	Type
1 Front personal light	---	8	F
2 Front interior light	---	8	E
3 Front vanity light	---	3	E
4 Rear vanity light	---	3	E
5 Rear interior light, Rear personal light	---	8	F
6 Door courtesy light	194	3.8	D

ELECTRICAL COMPONENTS

- A: HB3 halogen bulbs
- B: D2S discharge bulbs
- C: HB4 halogen bulbs
- D: Wedge base bulbs
- E: Double end bulbs
- F: Single end bulbs

SECTION 6-5

SERVICE PROCEDURES AND SPECIFICATIONS

Body

Specifications	520
Protecting your vehicle from corrosion	521
Washing and waxing	522
Cleaning the interior	524

BODY

SPECIFICATIONS

– DIMENSIONS AND WEIGHTS

Overall length	5015 mm (197.4 in.)
Overall width	1830 mm (72.0 in.)
Overall height – with electronically modulated air suspension – without electronically modulated air suspension	1470 mm (57.9 in.)* 1490 mm (58.7 in.)*
Wheelbase	2925 mm (115.2 in.)
Tread – Front with electronically modulated air suspension without electronically modulated air suspension – Rear with electronically modulated air suspension without electronically modulated air suspension	1575 mm (62.0 in.) 1570 mm (61.8 in.) 1575 mm (62.0 in.) 1570 mm (61.8 in.)
Vehicle capacity weight (occupants + cargo)	410 kg (900 lb.)
Towing capacity (trailer weight + cargo weight)	907 kg (2000 lb.)

*Unladen vehicle

– FUEL TANK

Capacity	84 L (22.2 gal., 18.5 Imp.gal.)
----------	---------------------------------

PROTECTING YOUR VEHICLE FROM CORROSION

Proper care of your Lexus can help ensure long-term corrosion prevention.

The most common causes of corrosion to your vehicle are:

- The accumulation of road salt, dirt and moisture in hard-to-reach areas under the vehicle.
- Chipping of paint or undercoating caused by minor accidents or by stones and gravel.

The following conditions will cause or accelerate corrosion of your vehicle, so it is important to keep your vehicle, particularly the underside, as clean as possible and to repair any damage to paint or protective coatings as soon as possible.

- The presence of road salt or dust control chemicals, salt in the air near the sea coast, industrial air pollution.
- High humidity, especially at temperatures just above freezing point.
- Certain parts of your vehicle are wet or damp for an extended period of time, even though other parts of the vehicle are dry.
- Components of the vehicle which are prevented from quick-drying due to lack of proper ventilation are exposed to high ambient temperature.

To help prevent corrosion on your Lexus, follow these guidelines:

Keep your vehicle clean by regular washing. In addition, observe the following points.

- If you drive on salted roads in the winter or if you live near the ocean, you should hose off the undercarriage at least once a month to minimize corrosion.
- High pressure water or steam is effective for cleaning the vehicle's underside and wheel housings. Pay particular attention to these areas as it is difficult to see all the mud and dirt. It will do more harm than good to simply wet the mud and debris without removing. The lower edge of doors, rocker panels and frame members have drain holes which should not be allowed to clog with dirt as trapped water in these areas can cause corrosion.
- Wash the underside of the vehicle thoroughly when winter is over.

See "Washing and waxing" on page 522 for more tips.

Check the condition of your vehicle's paint and trim. If you find any chips or scratches in the paint, touch them up immediately to prevent corrosion from starting. If the chips or scratches have gone through the bare metal, have a qualified body shop make the repair.

BODY

Check the interior of your vehicle. Water and dirt can accumulate under the floor mats and could cause corrosion. Occasionally check under the mats to make sure the area is dry. Be particularly careful when transporting chemicals, cleansers, fertilizers, salt, etc. These should be transported in proper containers. If a spill or leak should occur, immediately clean and dry the area.

Use mud shields on your wheels. If you drive on salted or gravel roads, mud shields help protect your vehicle. Full-size shields, which come as near to the ground as possible, are the best. We recommend that the fittings and the area where the shields are installed be treated to resist corrosion. Your Lexus dealer will be happy to assist in supplying and installing the shields if they are recommended for your area.

Keep your vehicle in a well ventilated garage or a roofed place. Do not park your vehicle in a damp, poorly ventilated garage. If you wash your vehicle in the garage, or if you drive it covered with water or snow, your garage may be so damp as to cause corrosion. Even if your garage is heated, a wet vehicle can corrode if the ventilation is poor.

WASHING AND WAXING

Washing your Lexus

Keep your vehicle clean by regular washing.

The following cases may cause weakness to the paint or corrosion to the body and parts. Wash your vehicle as soon as possible.

- When driving in a coastal area
- When driving on a road sprinkled with antifreeze
- When exposed to coal tar, tree sap, bird droppings and carcass of an insect
- When driving in areas where there is a lot of smoke, soot, dust, iron dust or chemical substance
- When the vehicle becomes remarkably dirty with dust and mud

Hand-washing your Lexus

Work in the shade and wait until the vehicle body is not hot to the touch.

1. Rinse off loose dirt with a hose. Remove any mud or road salt from the underside of the vehicle or in the wheel wells.
2. Wash with a mild car-wash soap, mixed according to the manufacturer's instructions. Use a soft cotton mitt and keep it wet by dipping it frequently into the wash water. Do not rub hard - let the soap and water remove the dirt.

Plastic wheel ornaments: The plastic wheel ornaments are damaged easily by organic substances. If any organic substance splashes an ornament, be sure to wash it off with water and check if the ornament is damaged.

 **CAUTION**

Do not attach the heavily damaged plastic wheel ornament. It may fly off the wheel and cause accidents while the vehicle is moving.

Aluminum wheels: Use only a mild soap or neutral detergent.

Urethane bumpers and side moldings: Wash carefully. Do not scrub with abrasive cleaners. The bumper and side molding faces are soft.

Road tar: Remove with turpentine or cleaners that are marked safe for painted surfaces.

NOTICE

Do not use organic substances (gasoline, kerosene, benzine or strong solvents), which may be toxic or cause damage.

3. Rinse thoroughly - dried soap can cause streaking. In hot weather you may need to rinse each section right after you wash it.

4. To prevent water spots, dry the vehicle using a clean soft cotton towel. Do not rub or press hard - you might scratch the paint.

Automatic car wash

NOTICE

To prevent damage to the antenna, make sure to remove it before driving your Lexus through an automatic car wash.

Your vehicle may be washed in an automatic car wash, but remember that the paint can be scratched by some types of brushes, unfiltered washing water, or the washing process itself. Scratching reduces paint durability and gloss, especially on darker colors. The manager of the car wash should be able to advise you whether the process is safe for the paint on your vehicle.

Waxing your Lexus

Polishing and waxing is recommended to maintain the original beauty of your Lexus' finish.

Apply wax once a month or if the vehicle surface does not repel water well.

1. Always wash and dry the vehicle before you begin waxing, even if you are using a combined cleaner and wax.
2. Use a good quality polish and wax. If the finish has become extremely weathered, use a car-cleaning polish, followed by a separate wax. Carefully follow the manufacturer's instructions and precautions. Be sure to polish and wax the chrome trim as well as the paint.

BODY

3. Wax the vehicle again when water does not bead but remains on the surface in large patches.

CLEANING THE INTERIOR



CAUTION

- Be careful not to splash water or spill liquid on the floor. This may prevent the side airbags from activating correctly, resulting in serious injury.
- Do not wash the vehicle floor with water, or allow water to get onto the floor when cleaning the vehicle interior or exterior. Water may get into audio components or other electrical components above or under the floor carpet (or mat) and cause a malfunction; and it may cause body corrosion.

Leather Interior

The selected leather is used in your Lexus. Due to characteristics of leather products, some parts of leather may be rough, uneven or scratched originally.

To keep good appearance, we recommend you to clean it periodically twice a year.

Remove dirt on the leather in the following ways:

1. Wipe it off lightly using a soft cloth (e.g. gauze) dampened with 5% solution of neutral detergent for wool.

2. Wring water from a clean cloth and thoroughly wipe off all traces of detergent with it.

3. Wipe off the surface of the leather with a dry soft cloth. Allow the leather to dry in a ventilated shaded area. Excess of wet may cause the hardening or shrinking of the leather.

NOTICE

- *Dirt or sand adhered to the leather may damage the treated surface and cause it to wear earlier. Remove dirt or sand using a vacuum cleaner.*
- *If a stain should fail to come out with a neutral detergent, apply a cleaner that does not contain an organic solvent.*
- *Never use organic substances such as benzine, alcohol or gasoline, or alkaline or acid solutions for cleaning the leather as these could cause discoloring.*
- *Use of a nylon brush or synthetic fiber cloth, etc. may scratch the fine grained surface of the leather.*
- *Mildew may develop on soiled leather upholstery. Be especially careful to avoid oil spots. Try to keep your upholstery always clean.*

- *Long exposure to direct sunlight may cause the leather surface to harden and shrink. Keep your vehicle in a shaded area, especially in the summer.*
- *The interior of your vehicle is apt to heat up on hot summer days, so avoid placing on the upholstery items made of vinyl or plastic or containing wax as these tend to stick to leather when warm.*
- *Improper cleaning of the leather upholstery could result in discoloration or staining.*

Synthetic Leather Areas (Dash and sun visors)

The synthetic leather areas may be easily cleaned with a mild soap or detergent and water.

First vacuum over the upholstery to remove loose dirt. Then, using a sponge or soft cloth, apply the soap solution to the synthetic leather. After allowing it to soak in for a few minutes to loosen the dirt, remove the dirt and wipe off the soap with a clean damp cloth. If all the dirt does not come off, repeat the procedure. Commercial foaming-type cleaners are also available which work well. Follow the manufacturer's instructions.

NOTICE

Do not use solvent, thinner, gasoline or window cleaner on the interior.

BODY

Carpets, Windows and Seat Belts

Begin by vacuuming thoroughly to remove as much dirt as possible. Several types of foam cleaners are available; some are in aerosol cans and others are powders or liquids which you mix with water to produce a foam. To shampoo the carpets, use a sponge or brush to apply the foam. Rub in overlapping circles. Do not apply water - the best results are obtained by keeping the carpet as dry as possible. Read the shampoo instructions and follow them closely.

The seat belts may be cleaned with mild soap and water or with lukewarm water.

Use a cloth or sponge. As you are cleaning, check the belts for excessive wear, fraying or cuts.

NOTICE

- *Use a good foam-type shampoo to clean the carpets.*
- *Do not use dye or bleach on the belts - it may weaken them.*
- *Do not use the belts until they become dry.*
- *The windows may be cleaned with any household window cleaner.*
- *When cleaning the inside of the rear window, be careful not to scratch or damage the heater wires or connectors.*

Air Conditioning Control Panel, Car Audio, Instrument Panel, Console Panel, and Switches

Use a soft damp cloth for cleaning.

Soak a clean soft cloth in water or lukewarm water then lightly wipe off any dirt.

NOTICE

- *Do not use organic substances (solvents, kerosene, alcohol, gasoline, etc.) or alkaline or acidic solutions. These chemicals can cause discoloring, staining or peeling of the surface.*
- *If you use cleaners or polishing agents, make sure their ingredients do not include the substances mentioned above.*
- *If you use a liquid car freshener, do not spill the liquid onto the vehicle's interior surfaces. It may contain the ingredients mentioned above. Immediately clean any spill using the method mentioned above.*

If you have any questions about the cleaning of your Lexus, your local Lexus dealer will be pleased to answer them.

SECTION 7

REPORTING SAFETY DEFECTS FOR U.S. OWNERS

Reporting safety defects for U.S. owners

Reporting safety defects for U.S. owners 528

REPORTING SAFETY DEFECTS FOR U.S. OWNERS

REPORTING SAFETY DEFECTS FOR U.S. OWNERS

If you believe that your vehicle has a defect which could cause a crash or could cause injury or death, you should immediately inform the National Highway Traffic Safety Administration (NHTSA) in addition to notifying Toyota Motor Sales, U.S.A., Inc. (Toll-free: 1-800-25-LEXUS).

If NHTSA receives similar complaints, it may open an investigation, and if it finds that a safety defect exists in a group of vehicles, it may order a recall and remedy campaign. However, NHTSA cannot become involved in individual problems between you, your dealer, or Toyota Motor Sales, U.S.A., Inc.

To contact NHTSA, you may either call the Auto Safety Hotline toll-free at 1-800-424-9393 (or 366-0123 in Washington, D.C. area) or write to: NHTSA, U.S. Department of Transportation, Washington, D.C. 20590. You can also obtain other information about motor vehicle safety from the Hotline.

GAS STATION INFORMATION

- **Fuel selection:**
Select premium unleaded gasoline with an Octane Rating of 91 (Research Octane Number 96) or higher for optimum engine performance. However, if such premium type cannot be obtained, you may temporarily use unleaded gasoline with an Octane Rating as low as 87 (Research Octane Number 91).
- **Fuel tank capacity:**
84 L (22.2 gal., 18.5 Imp.gal.)
- **Engine oil:**
"Toyota Genuine Motor Oil" or equivalent

Oil grade: API grade SL "Energy-Conserving" or ILSAC multigrade engine oil.

Recommended oil viscosity - SAE 5W- 30 if normal temperatures are below 38°C (100°F)

Oil capacity: L (qt., Imp.qt.)
Drain and refill
 with filter 5.1 (5.4, 4.5)
 without filter 4.5 (4.8, 4.0)
See page 461 for detailed information.
- **Engine coolant:**
Capacity: 9.5 L (10.0 qt, 8.4 Imp.qt.)

Coolant type - "Toyota Super Long Life Coolant" or similar high quality ethylene glycol based non-silicate, non-amine, non- nitrite, and non-borate coolant with long- life hybrid organic acid technology

Do not use plain water alone.

For checking the engine coolant, see page 464.

- **Automatic transmission:**
Fluid type - "Toyota Genuine ATF WS"

See page 470 for detailed information.

- **Tire information:**
See page 476 through 494 for detailed information.

- **Tire pressure:**

Tire size	Front	Rear
P225/55R17 95H	220 (2.2, 32)	220 (2.2, 32)
245/45R18 96W	230 (2.3, 33)	230 (2.3, 33)

For sustained high speeds above 160 km/h (100 mph), in countries where such speeds are permitted by law, add the tire pressure given below to the front tires and rear tires, but never exceed the maximum cold tire pressure molded on the tire sidewall.

P225/55R17 95H	20kPa (0.2 kgf/cm ² or bar, 3 psi)
245/45R18 96W	40kPa (0.4 kgf/cm ² or bar, 6 psi)