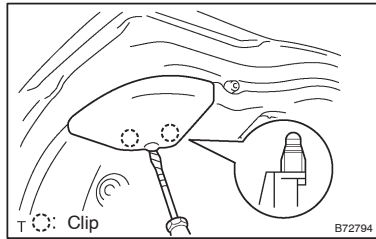

**OVERHAUL****HINT:**

- The installation procedures are the removal procedures in reverse order. However, only installation procedures requiring additional information are included.
- A bolt without a torque specification is shown in the standard bolt chart (see page 03-2).

**1. REMOVE REAR COMBINATION LAMP SERVICE COVER LH**

- (a) Using a screwdriver, disengage the 2 clips and remove the cover.

**HINT:**

Tape the screwdriver tip before use.

**2. REMOVE REAR COMBINATION LAMP SERVICE COVER RH**

- (a) Using a screwdriver, disengage the 2 clips and remove the cover.

**HINT:**

Tape the screwdriver tip before use.

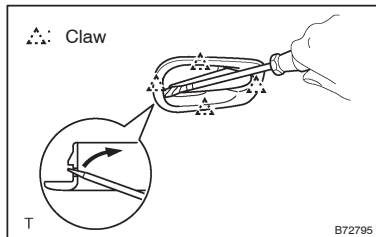
**3. REMOVE DOOR INSIDE HANDLE BEZEL**

- (a) Using a screwdriver, disengage the 4 claws and remove the bezel.

**HINT:**

Tape the screwdriver tip before use.

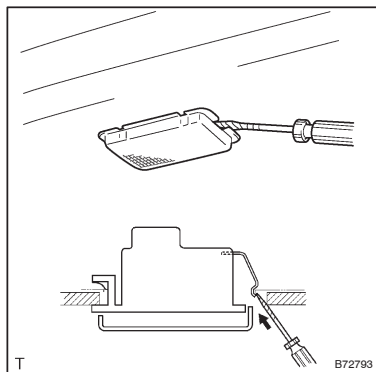
**4. REMOVE LUGGAGE COMPARTMENT LAMP ASSY NO.1**

- (a) Using a screwdriver, disengage the clip and remove the lamp.

**HINT:**

Tape the screwdriver tip before use.

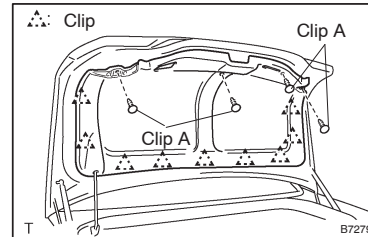
**5. REMOVE BACK DOOR TRIM COVER**

- (a) Using a clip remover, remove the 4 clips labelled A.  
 (b) Using a screwdriver, remove the 9 clips and cover.

**HINT:**

Tape the screwdriver tip before use.

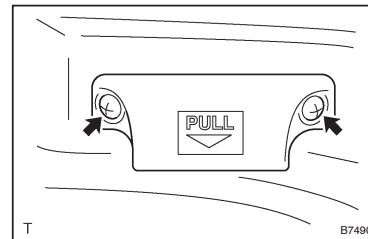
**6. REMOVE LUGGAGE COMPARTMENT DOOR ASSIST GRIP**

- (a) Remove the 2 screws and grip.

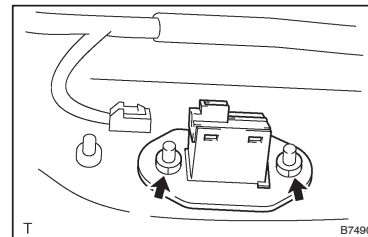
**7. REMOVE REAR LAMP ASSY LH (See page 65-20)****8. REMOVE REAR LAMP ASSY RH****9. REMOVE LICENSE PLATE LAMP LENS (See page 65-21)****10. REMOVE LUGGAGE COMPARTMENT DOOR GARNISH SUB-ASSY OUTSIDE (See page 76-37)****11. w/ Smart key system:****REMOVE LUGGAGE ELECTRICAL KEY SWITCH**

- (a) Disconnect the connector.  
 (b) Remove the 2 nuts and key switch.

**12. w/o Smart key system:****REMOVE LUGGAGE ELECTRICAL KEY SWITCH COVER**

- (a) Remove the 2 nuts and cover.

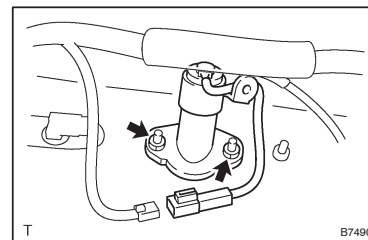
**13. REMOVE LUGGAGE COMPARTMENT DOOR LOCK CYLINDER ASSY**

- (a) Disconnect the connector.  
 (b) Remove the 2 nuts and lock cylinder.

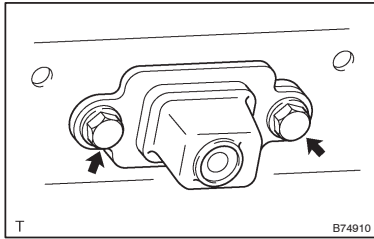

- 14. w/ Camera:  
REMOVE TELEVISION CAMERA ASSY**  
(a) Remove the 2 bolts and camera.

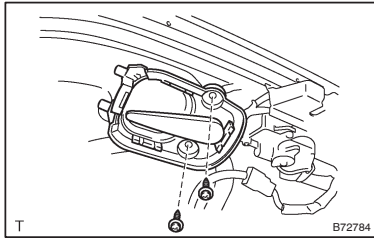

- 15. REMOVE LUGGAGE DOOR LOCK OPENER ASSY**  
(a) Remove the 2 screws and opener.

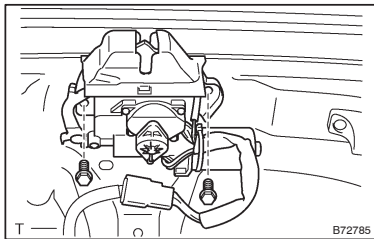

- 16. REMOVE LUGGAGE DOOR CLOSER ASSY**  
(a) Disconnect the connector.  
(b) Remove the 2 bolts and door closer.

**17. REMOVE LUGGAGE COMPARTMENT DOOR SUPPORT ASSY (See page 75-55)**

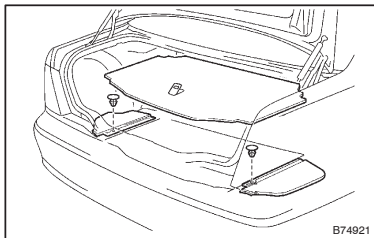

- 18. REMOVE LUGGAGE COMPARTMENT FLOOR MAT**  
(a) Remove the 4 bolts and 4 luggage compartment trim hooks No. 1.  
(b) Remove the mat.  
(c) Remove the 2 clips and 2 deck side trim boards.

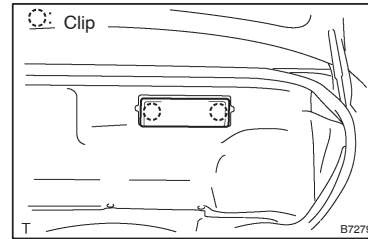

- 19. REMOVE LUGGAGE COMPARTMENT TRIM COVER FRONT**  
(a) w/ Special utility package:  
Remove the 2 clips and cover.

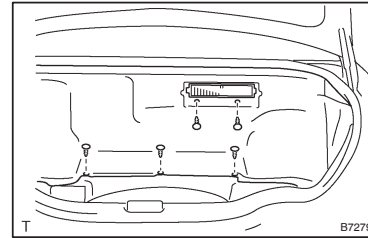

- (b) w/ Special utility package:  
Using a clip remover, remove the 5 clips.

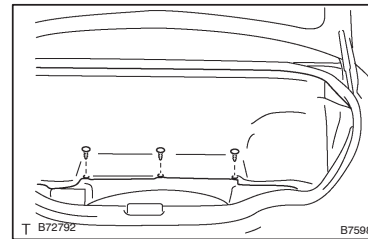

- (c) w/o Special utility package:  
Using a clip remover, remove the 3 clips.

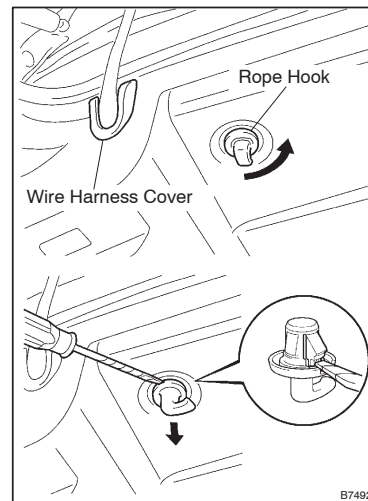

- (d) Using a screwdriver, remove the wire harness cover.  
HINT:  
Tape the screwdriver tip before use.  
(e) Using a screwdriver, remove the 2 rope hooks.  
HINT:  
Turn the rope hook 90 degrees counterclockwise. Insert a screwdriver (with its tip taped) into the slit in the side of the rope hook. Hold down the claw inside the slit and remove the rope hook as shown in the illustration.

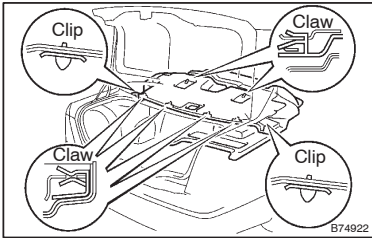

- (f) w/ Special utility package:  
Remove the 2 clips.
- (g) w/ Special utility package:  
Disengage the 6 claws and remove the cover.

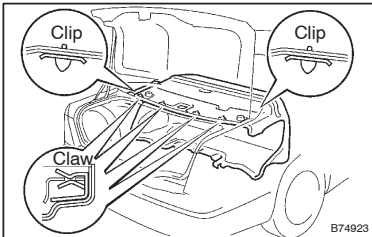

- (h) w/ Special utility package:  
Remove the 2 clips.
- (i) w/ Special utility package:  
Disengage the 4 claws and remove the cover.

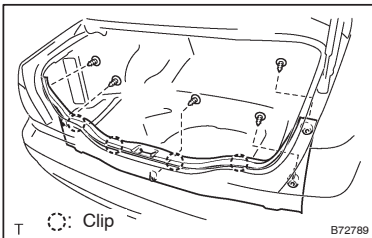

- 20. REMOVE REAR FLOOR FINISH PLATE**
- (a) Using a clip remover, remove the 5 clips.
- (b) Using a screwdriver, disengage the 4 clips and remove the plate.

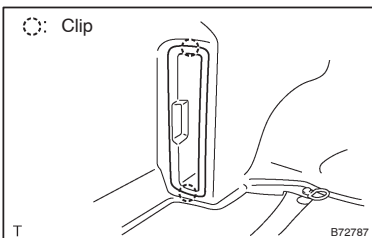

- 21. REMOVE LUGGAGE COMPARTMENT TRIM COVER ASSY LH**
- (a) Remove the tool bag.
- (b) Remove the side trim tool bag cover.

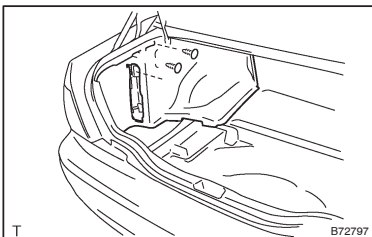

- (c) w/o Special utility package:  
Using a clip remover, remove the 2 clips and trim cover.

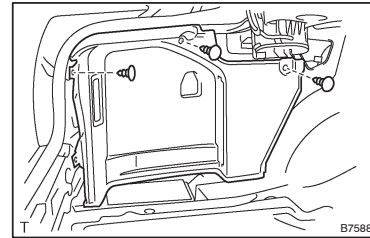

- (d) w/ Special utility package:  
Using a clip remover, remove the 3 clips and trim cover.

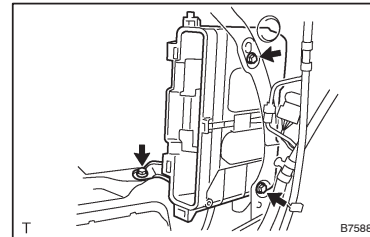

- (e) Remove the 3 bolts and tool box.

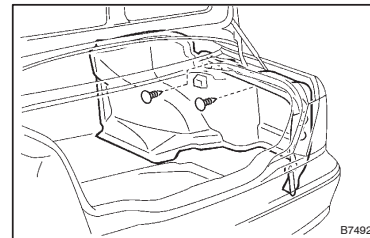

- 22. REMOVE LUGGAGE COMPARTMENT TRIM COVER ASSY RH**
- (a) w/o Special utility package:  
Using a clip remover, remove the 2 clips and trim.

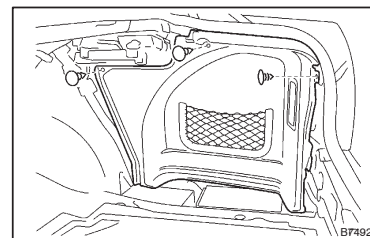

- (b) w/ Special utility package:  
Using a clip remover, remove the 3 clips and trim.

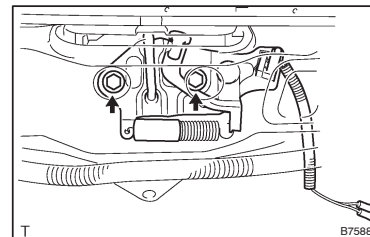

- 23. REMOVE LUGGAGE COMPARTMENT DOOR STRIKER ASSY**
- (a) Disconnect the striker connector.
- (b) Remove the 2 bolts and striker.

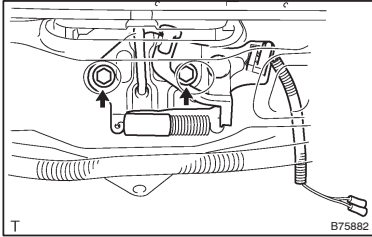

**24. INSTALL LUGGAGE COMPARTMENT DOOR STRIKER ASSY**

- (a) Install the striker with the 2 bolts.  
**Torque: 5.5 N·m (56 kgf·cm, 49 ft·lbf)**  
 (b) Connect the connector.

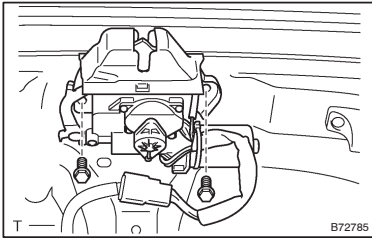

**25. INSTALL LUGGAGE DOOR CLOSER ASSY**

- (a) Install the door closer with the 2 bolts.  
**Torque: 5.5 N·m (56 kgf·cm, 49 in·lbf)**  
 (b) Connect the connector.

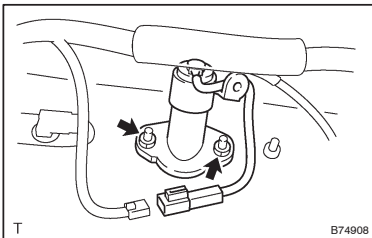

**26. INSTALL LUGGAGE COMPARTMENT DOOR LOCK CYLINDER ASSY**

- (a) Install the lock cylinder with the 2 nuts.  
**Torque: 5.5 N·m (56 kgf·cm, 49 in·lbf)**  
 (b) Connect the connector.

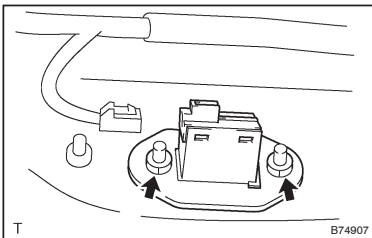

**27. w/ Smart key system:  
 INSTALL LUGGAGE ELECTRICAL KEY SWITCH**

- (a) Install the switch with the 2 nuts.  
**Torque: 8.0 N·m (82 kgf·cm, 71 in·lbf)**  
 (b) Connect the connector.

**28. w/o Smart key system:  
 INSTALL LUGGAGE ELECTRICAL KEY SWITCH COVER**

- (a) Install the cover with the 2 nuts.  
**Torque: 8.0 N·m (82 kgf·cm, 71 in·lbf)**