

Subject: 1999–2003 Lexus RX300 components, wiring diagrams, connector locations and pinouts

Source: Lexus service manuals

**NOTE:**

TRAC = Traction Control

This reference contains the following illustrations:

- [Figure TA2068-1](#) 1999–2000 RX300 component locations
- [Figure TA2068-2](#) 1999 RX300 connector pinouts
- [Figure TA2068-3](#) 1999 RX300 (w/o TRAC) wiring diagram (2 sheets)
- [Figure TA2068-4](#) 1999 RX300 (w/TRAC) wiring diagram (3 sheets)
- [Figure TA2068-5](#) 2000 RX300 connector pinouts
- [Figure TA2068-6](#) 2000 RX300 (w/o TRAC) wiring diagram (2 sheets)
- [Figure TA2068-7](#) 2000 RX300 (w/TRAC) wiring diagram (3 sheets)
- [Figure TA2068-8](#) 2001–02 RX300 component locations
- [Figure TA2068-9](#) 2001–02 RX300 connector pinouts
- [Figure TA2068-10](#) 2001–02 RX300 wiring diagram (4 sheets)
- [Figure TA2068-11](#) 2001–03 RX300 connector joints and grounds (2 sheets)
- [Figure TA2068-12](#) 2003 RX300 component locations
- [Figure TA2068-13](#) 2003 RX300 wiring diagram (4 sheets)
- [Figure TA2068-14](#) 2003 RX300 connector pinouts (2 sheets)

**NOTE:**

See Reference TA2001 for wire color code and important connector information.

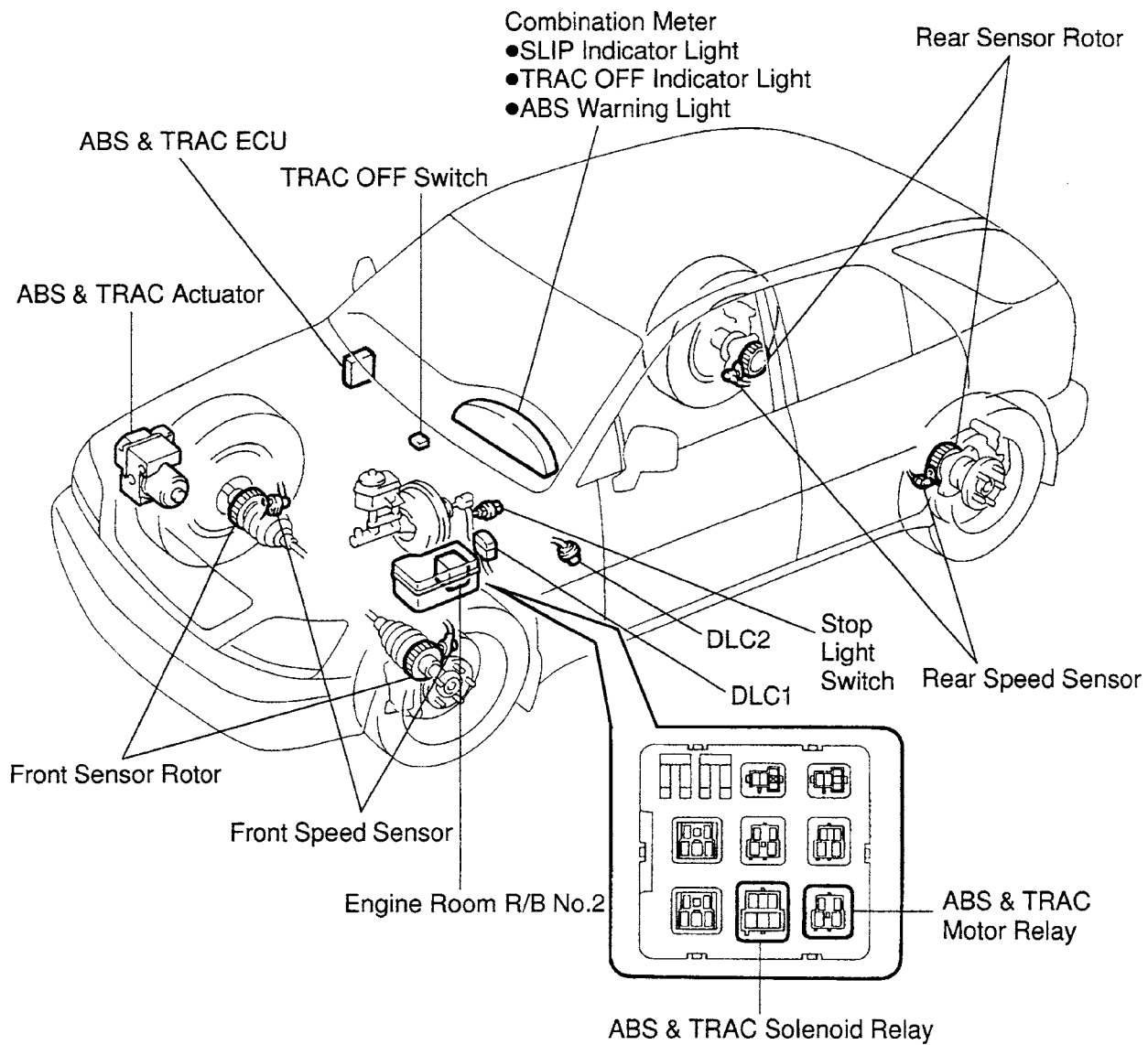

Figure TA2068-1 1999-2000 RX300 component locations

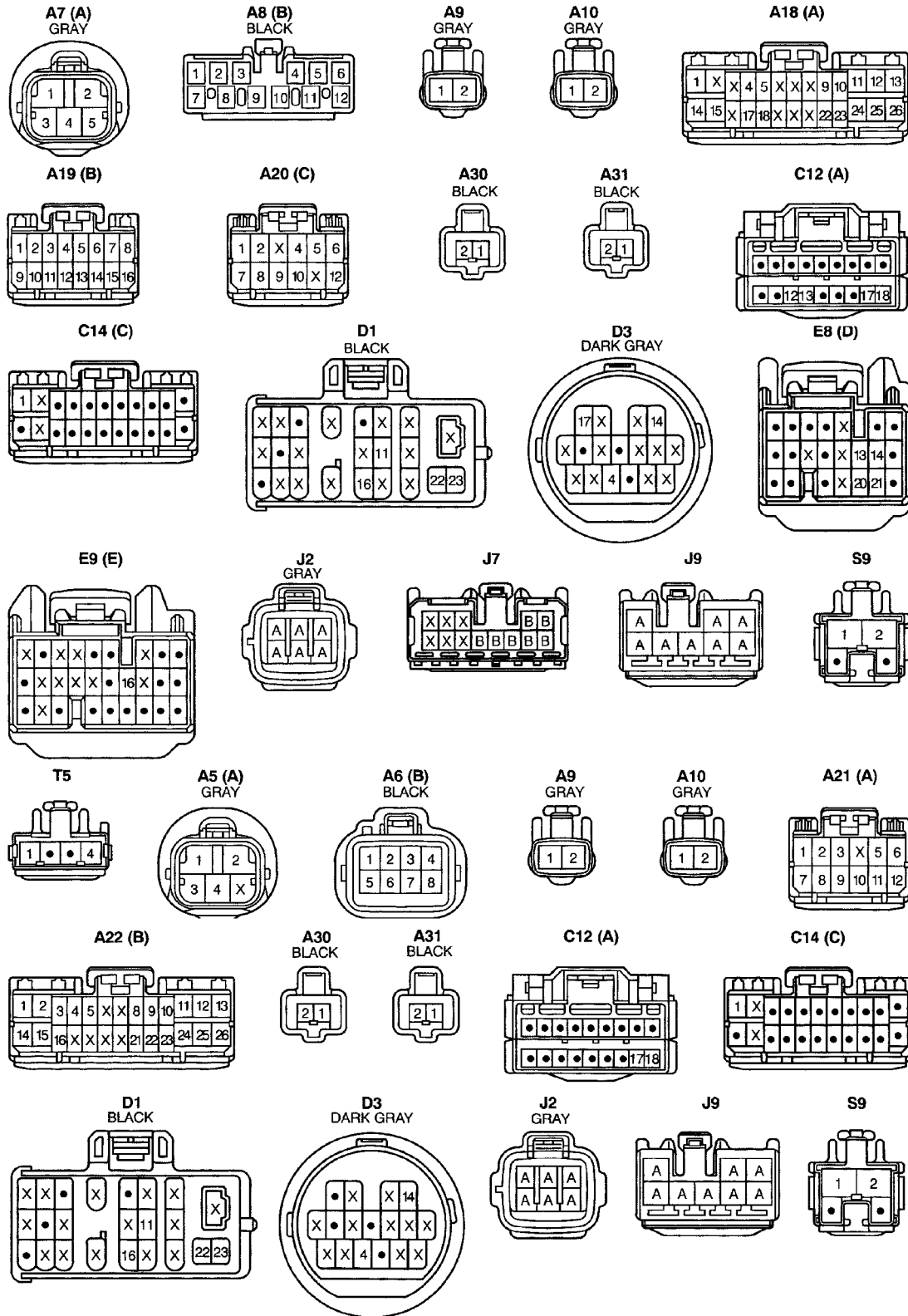

Figure TA2068-2 1999 RX300 connector pinouts

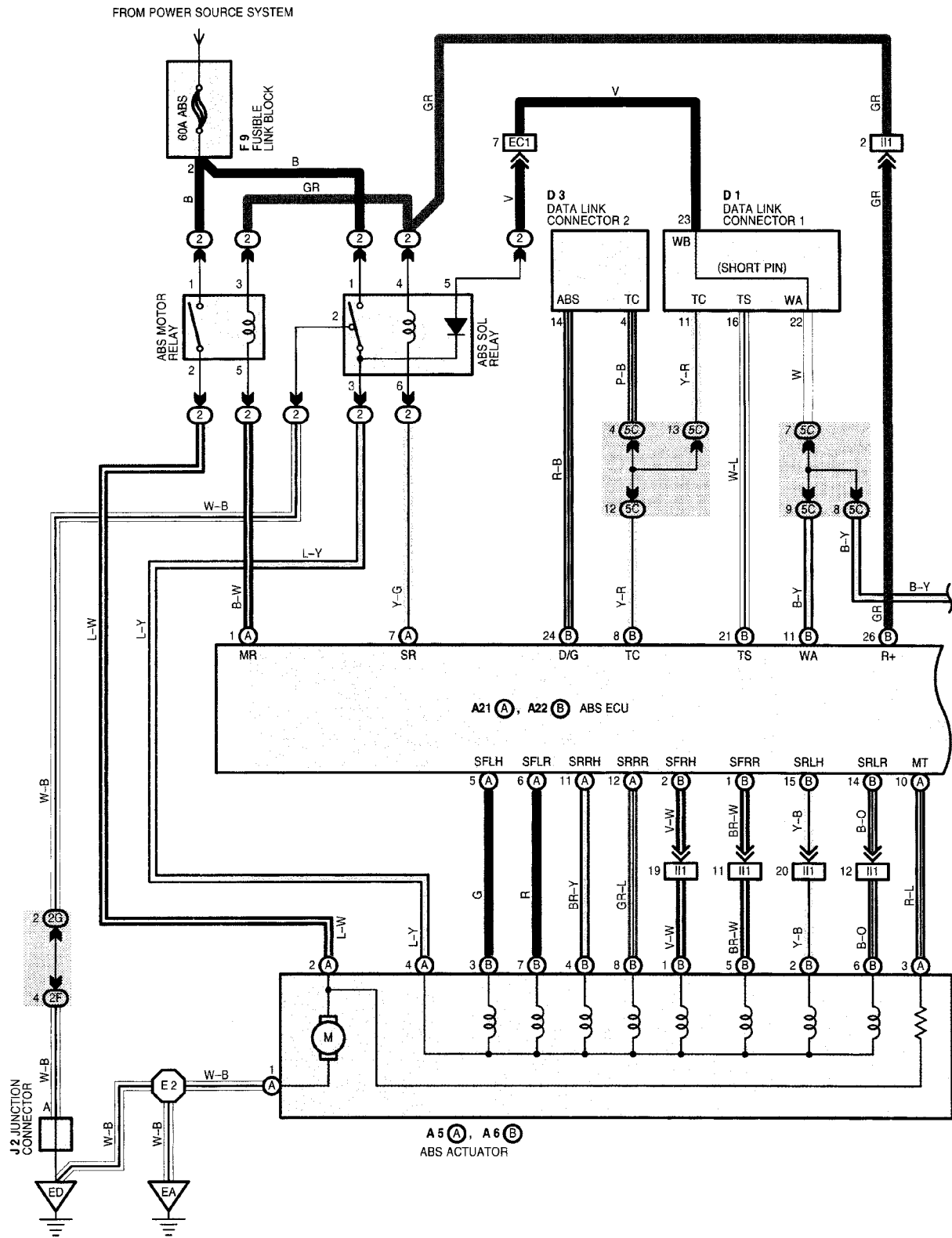

Figure TA2068-3 1999 RX300 (w/o TRAC) wiring diagram (sheet 1 of 2)

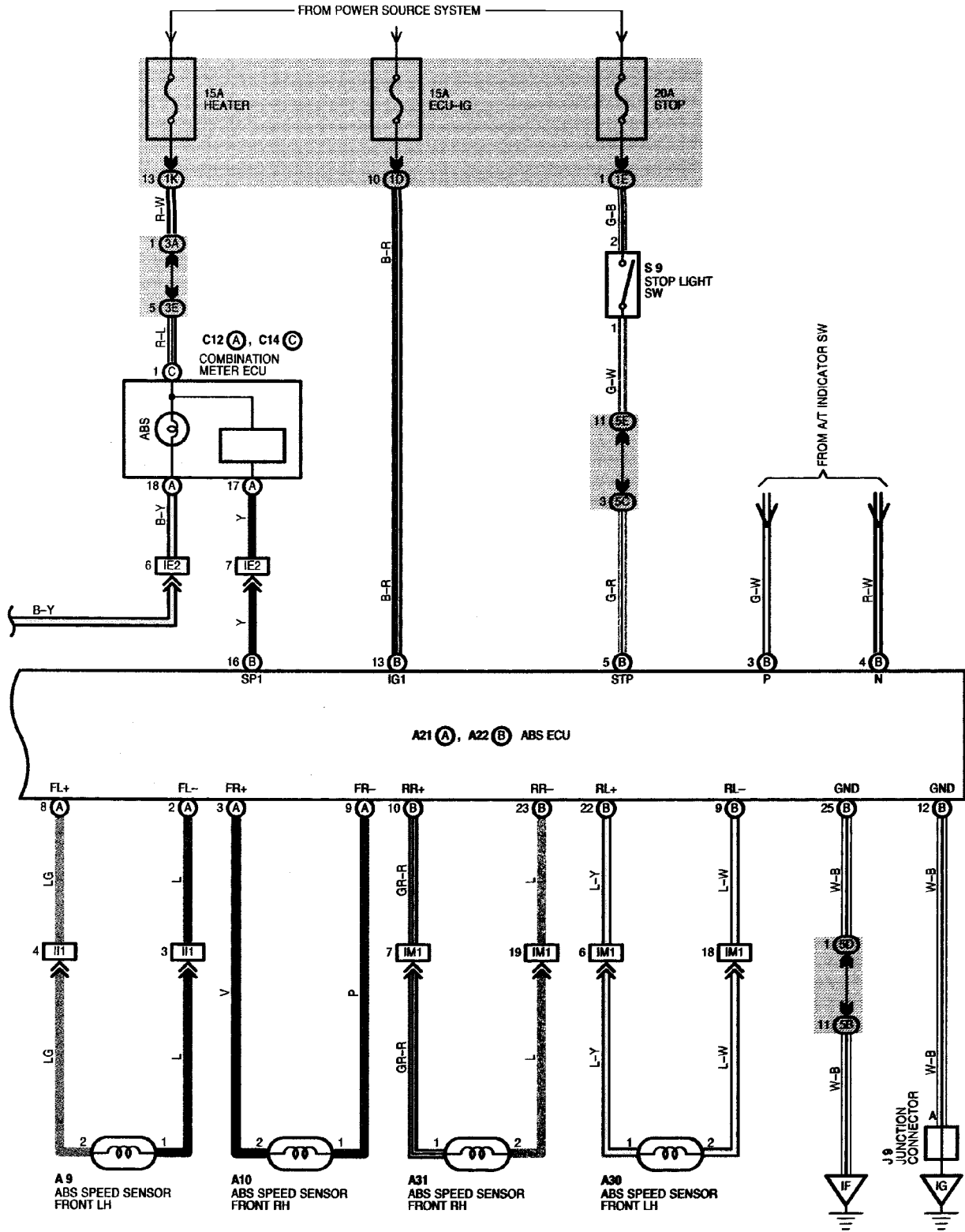

Figure TA2068-3 1999 RX300 (w/o TRAC) wiring diagram (sheet 2 of 2)

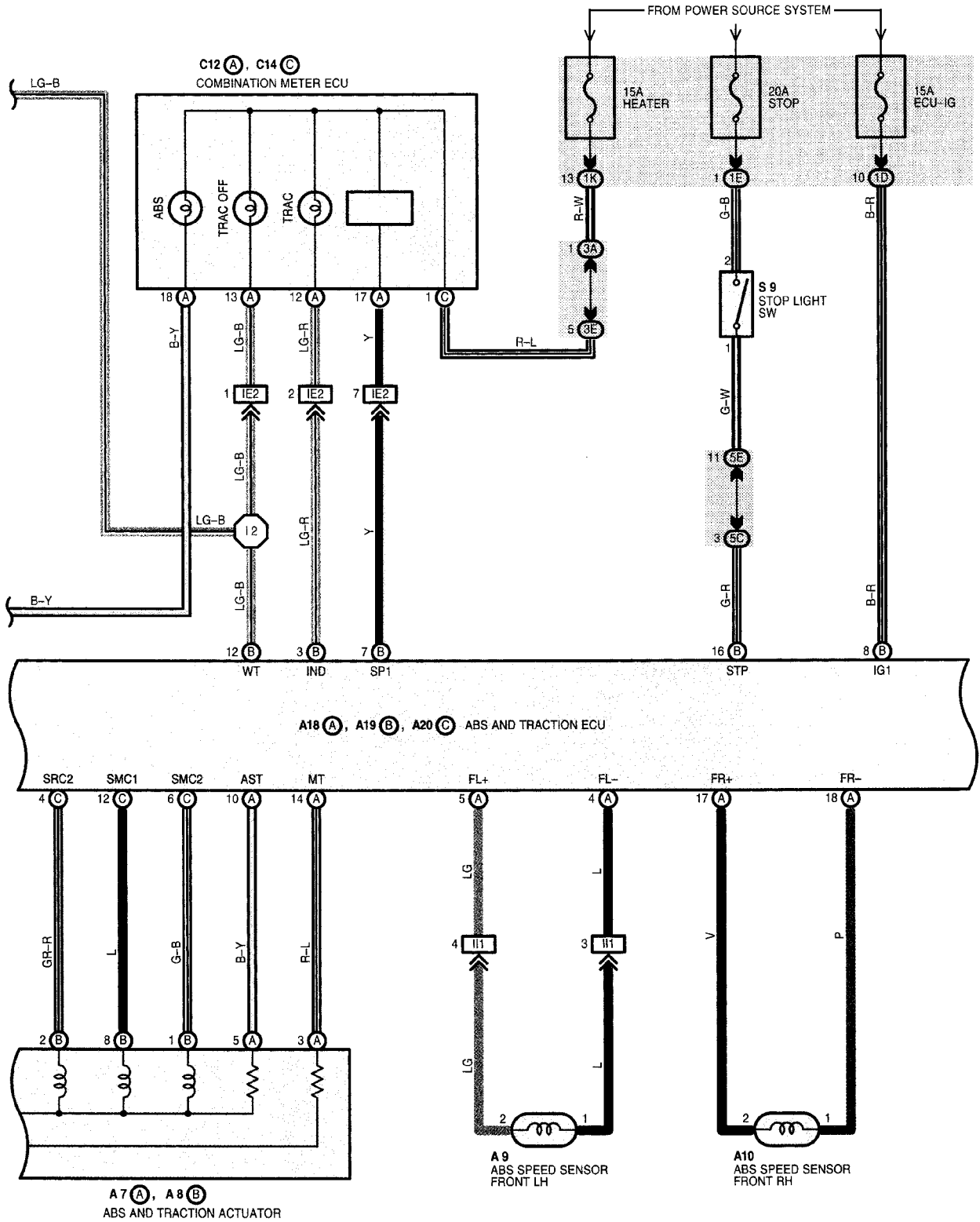

Figure TA2068-4 1999 RX300 (w/TRAC) wiring diagram (sheet 2 of 3)

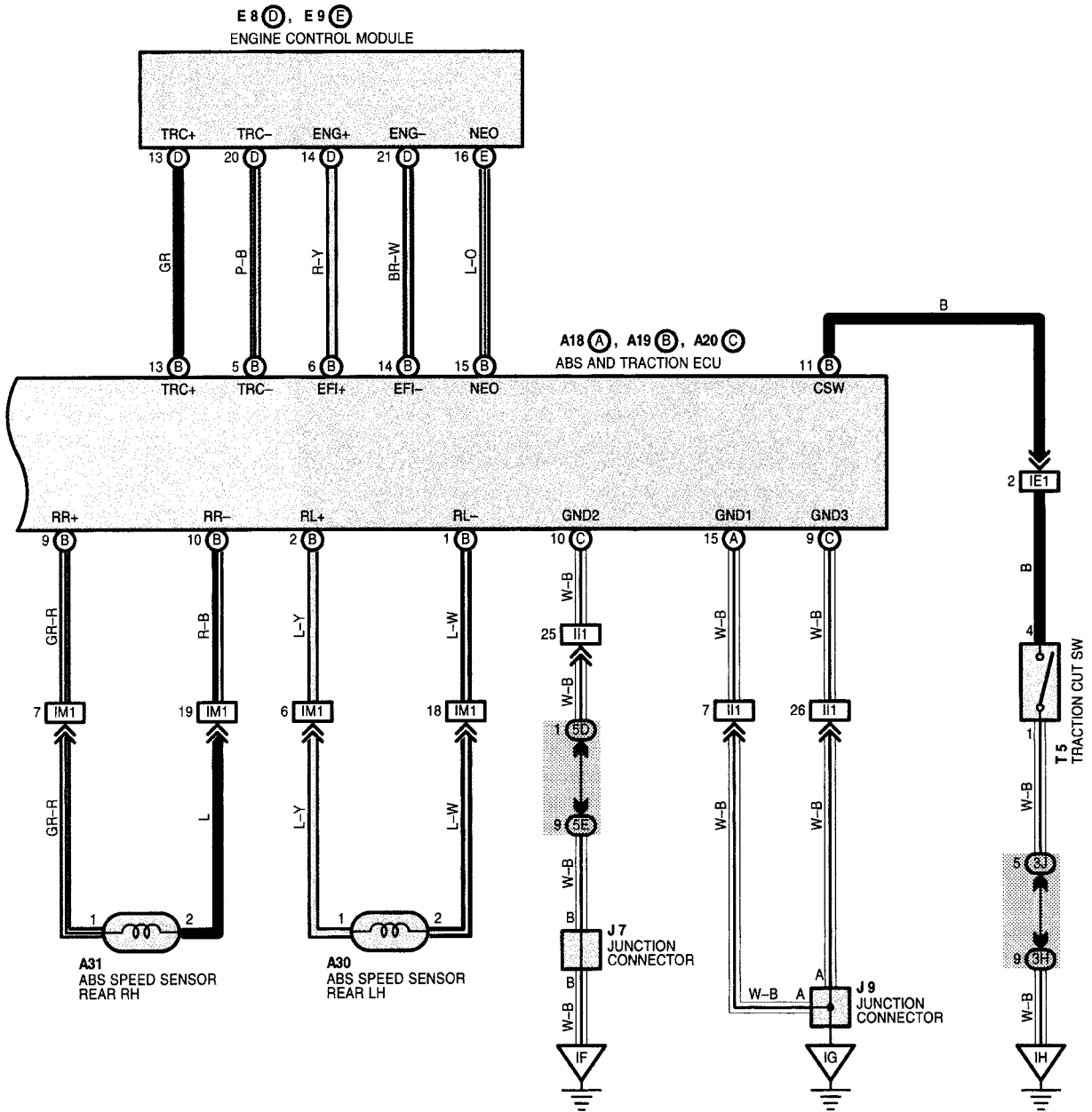

Figure TA2068-4 1999 RX300 (w/TRAC) wiring diagram (sheet 3 of 3)

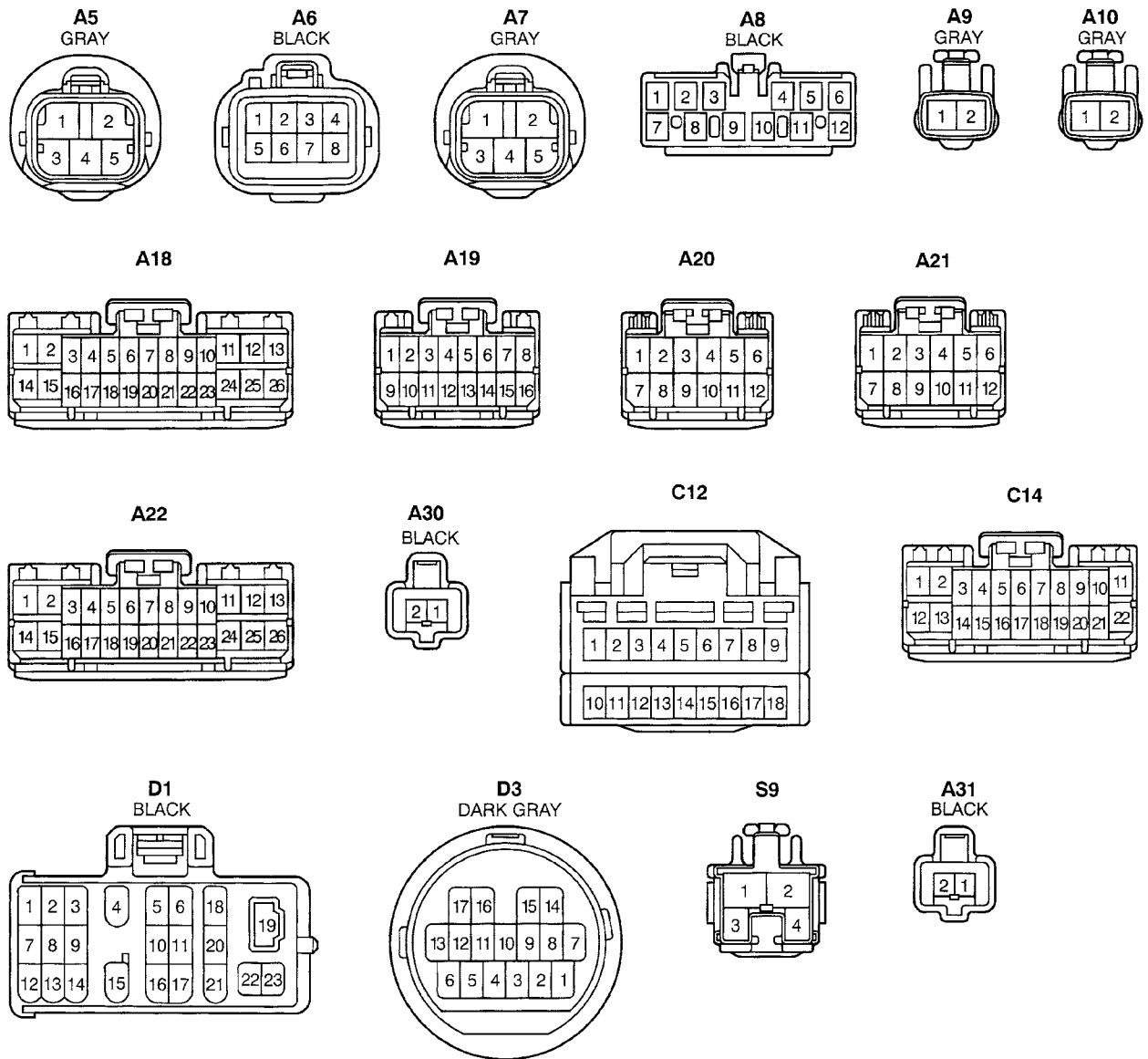

Figure TA2068-5 2000 RX300 connector pinouts

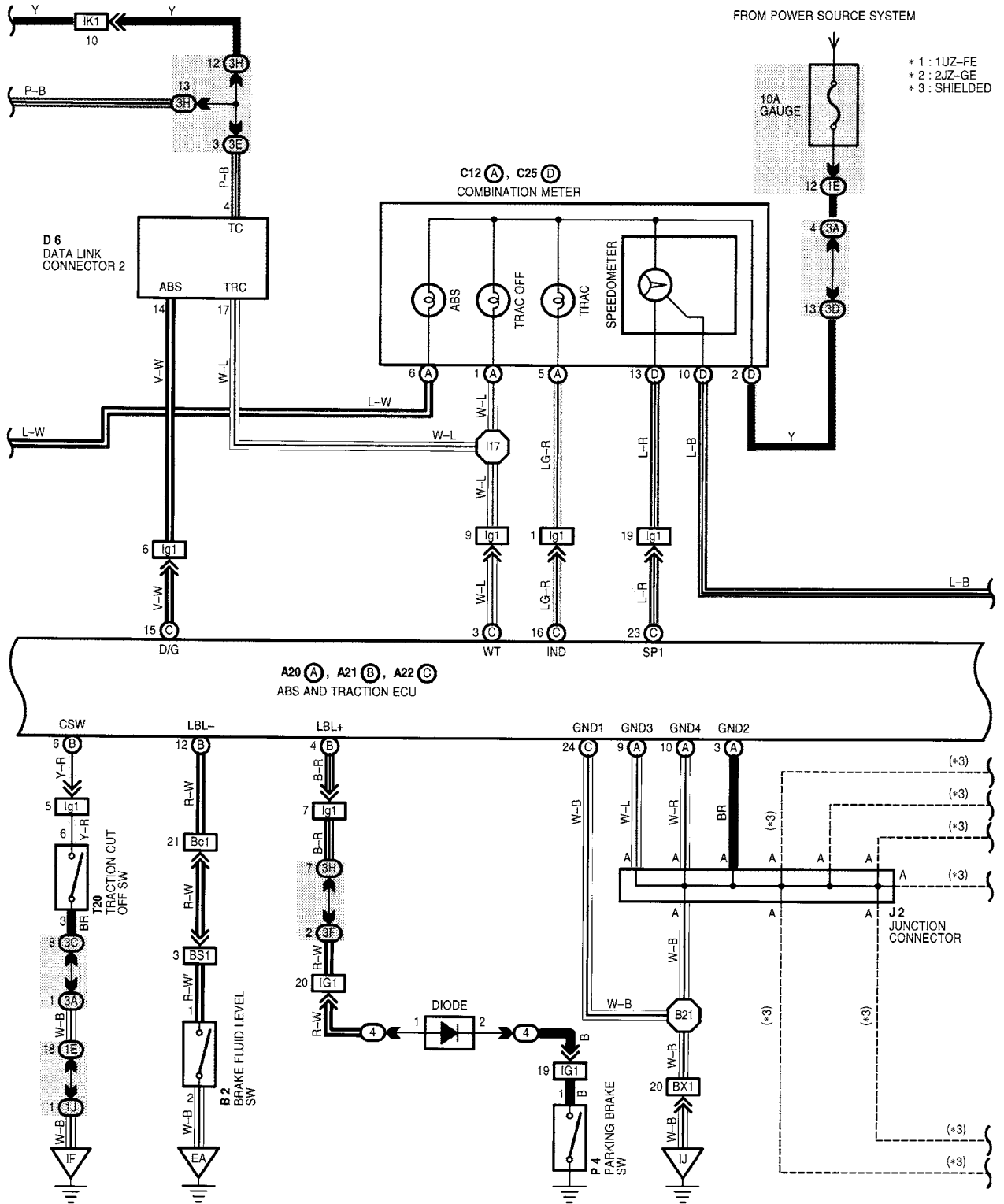

Figure TA2068-6 2000 RX300 (w/o TRAC) wiring diagram (sheet 1 of 2)

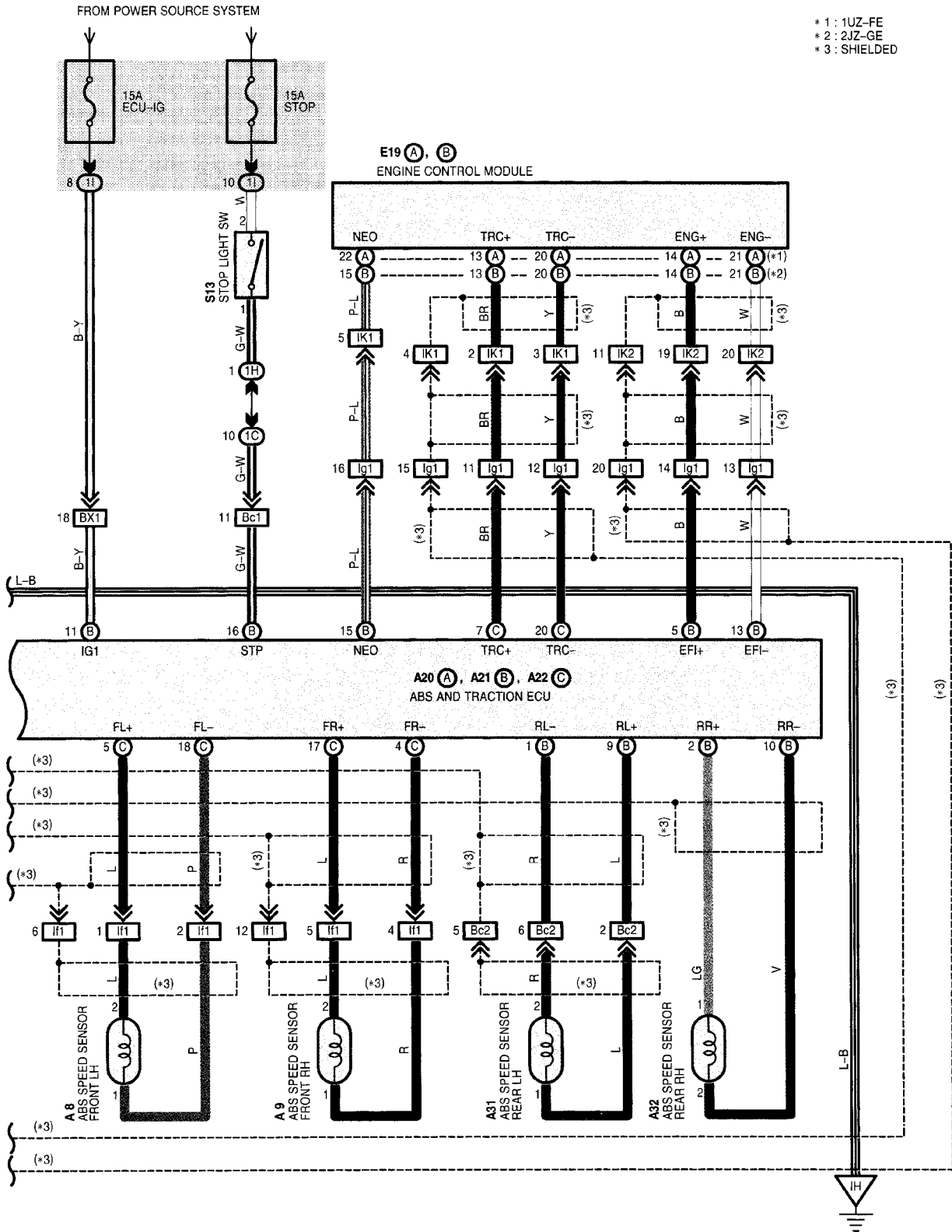

Figure TA2068-6 2000 RX300 (w/o TRAC) wiring diagram (sheet 2 of 2)

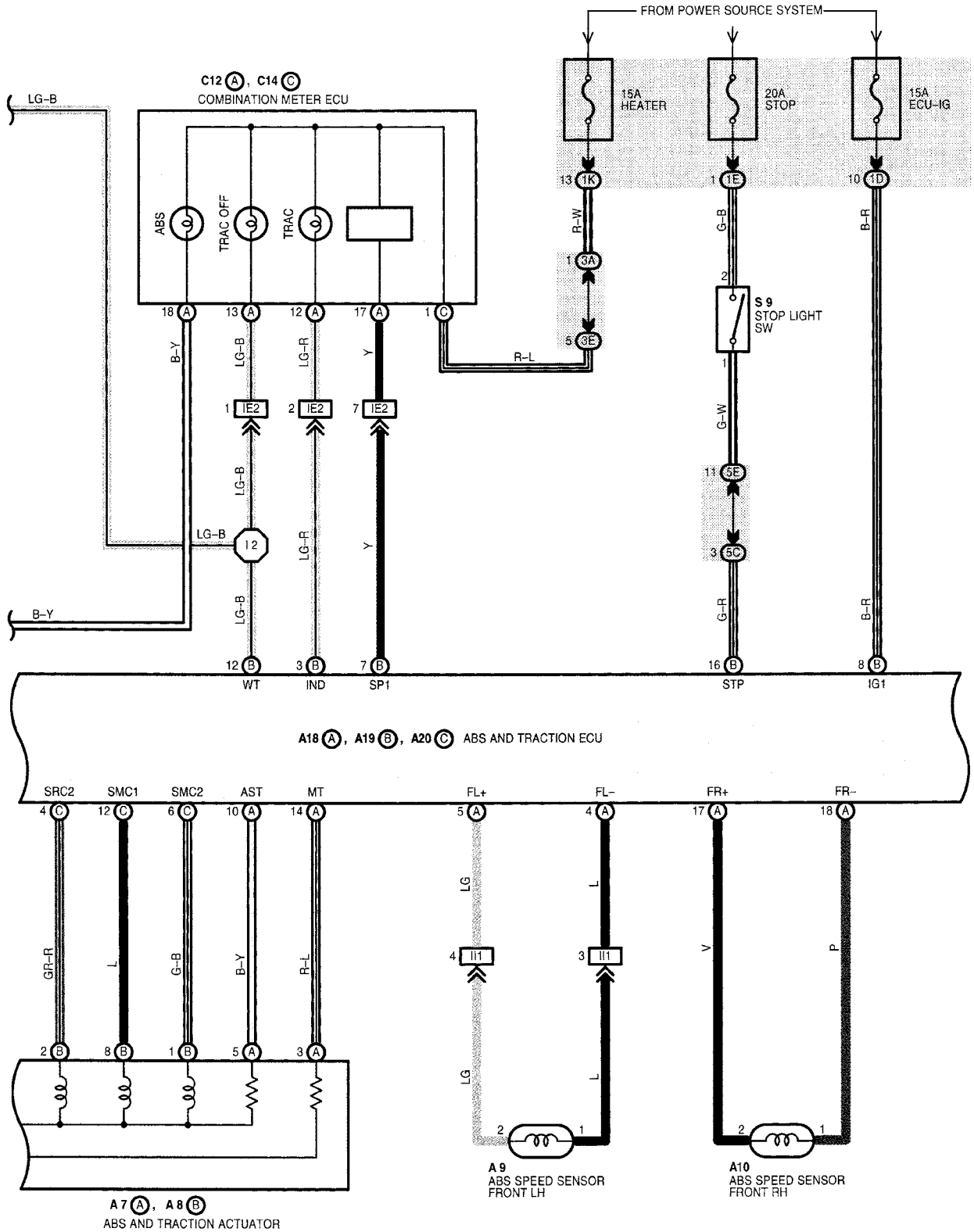

Figure TA2068-7 2000 RX300 (w/TRAC) wiring diagram (sheet 2 of 3)

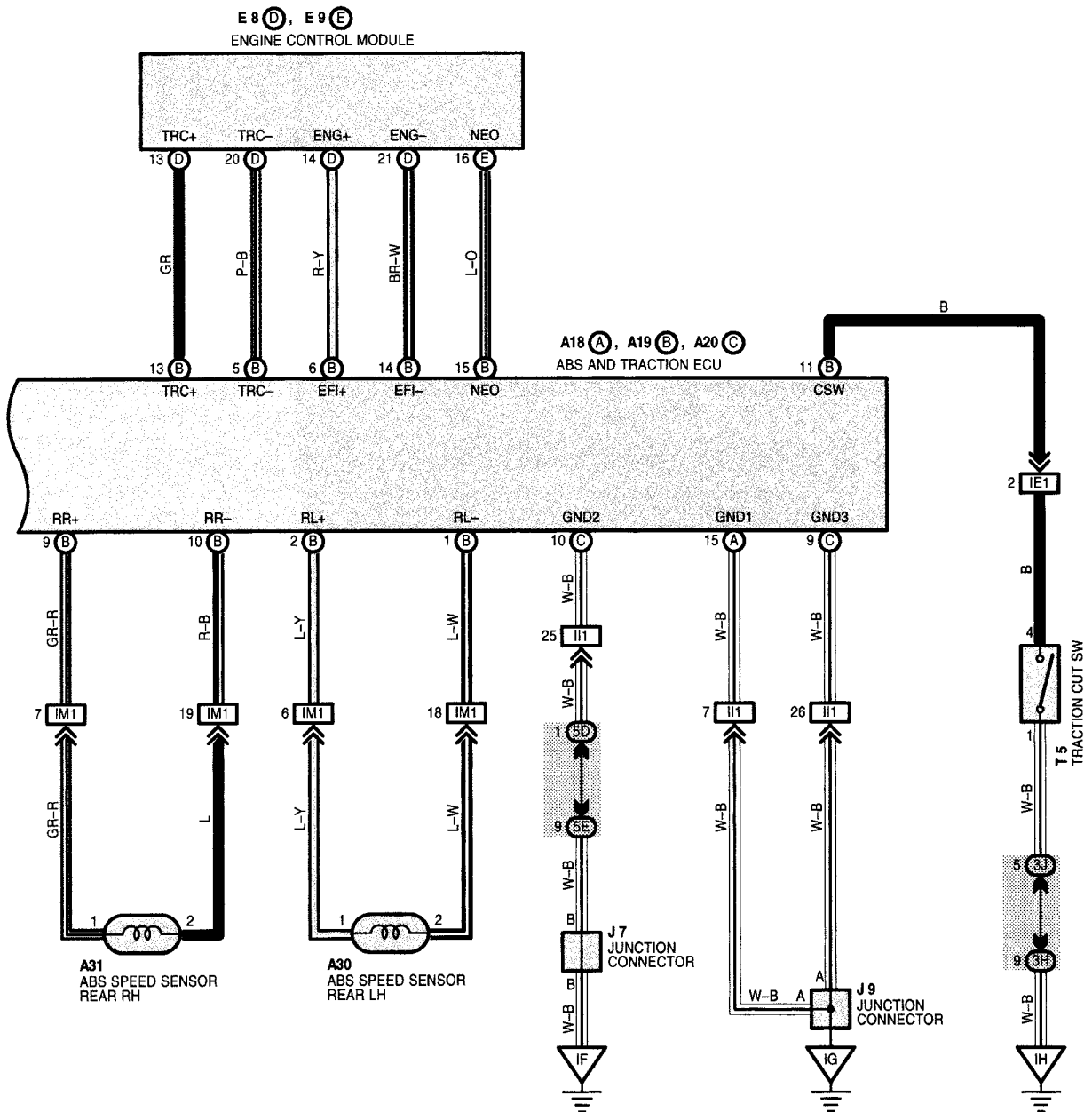
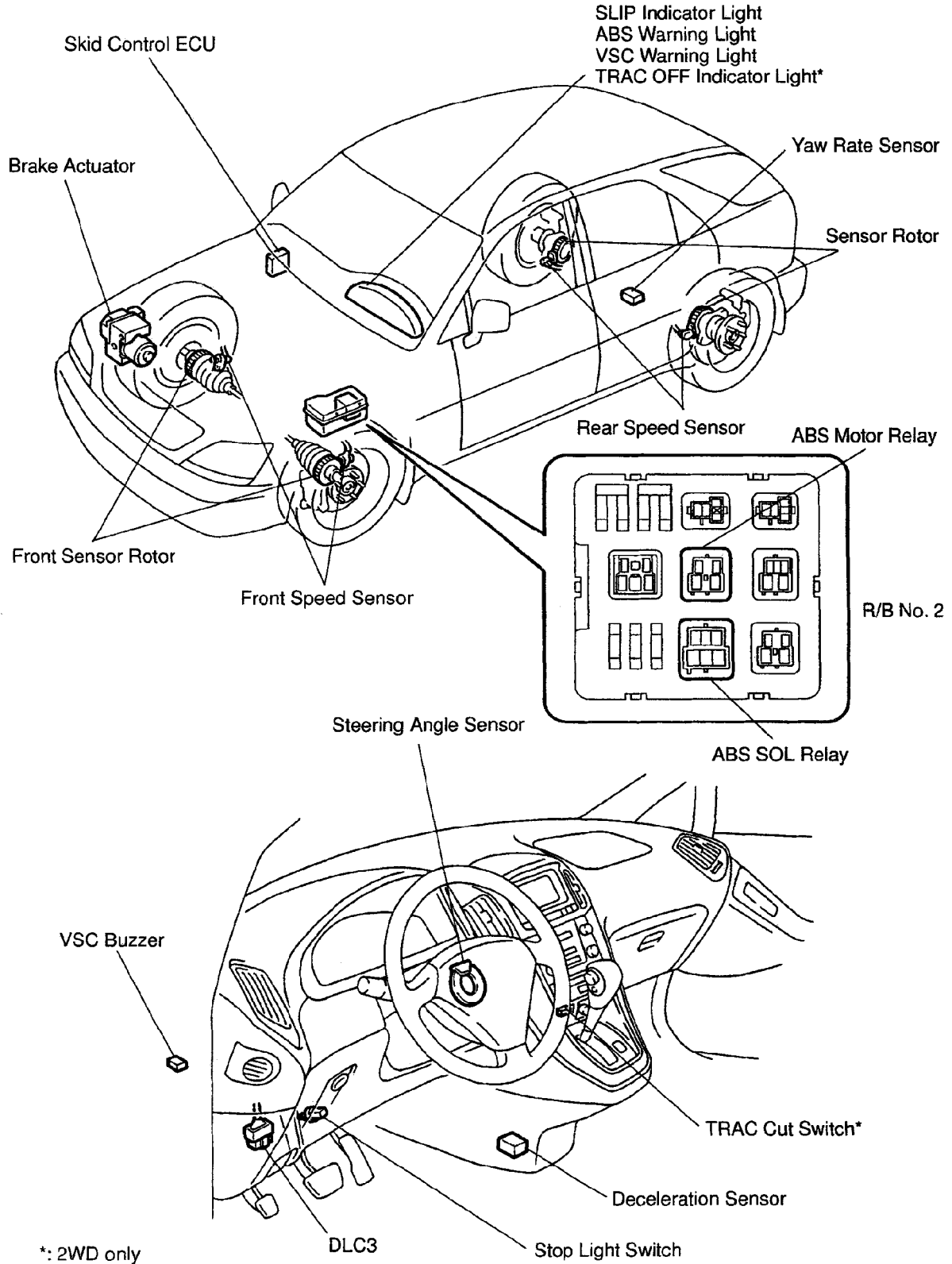

Figure TA2068-7 2000 RX300 (w/TRAC) wiring diagram (sheet 3 of 3)



*: 2WD only

Figure TA2068-8 2001-02 RX300 component locations

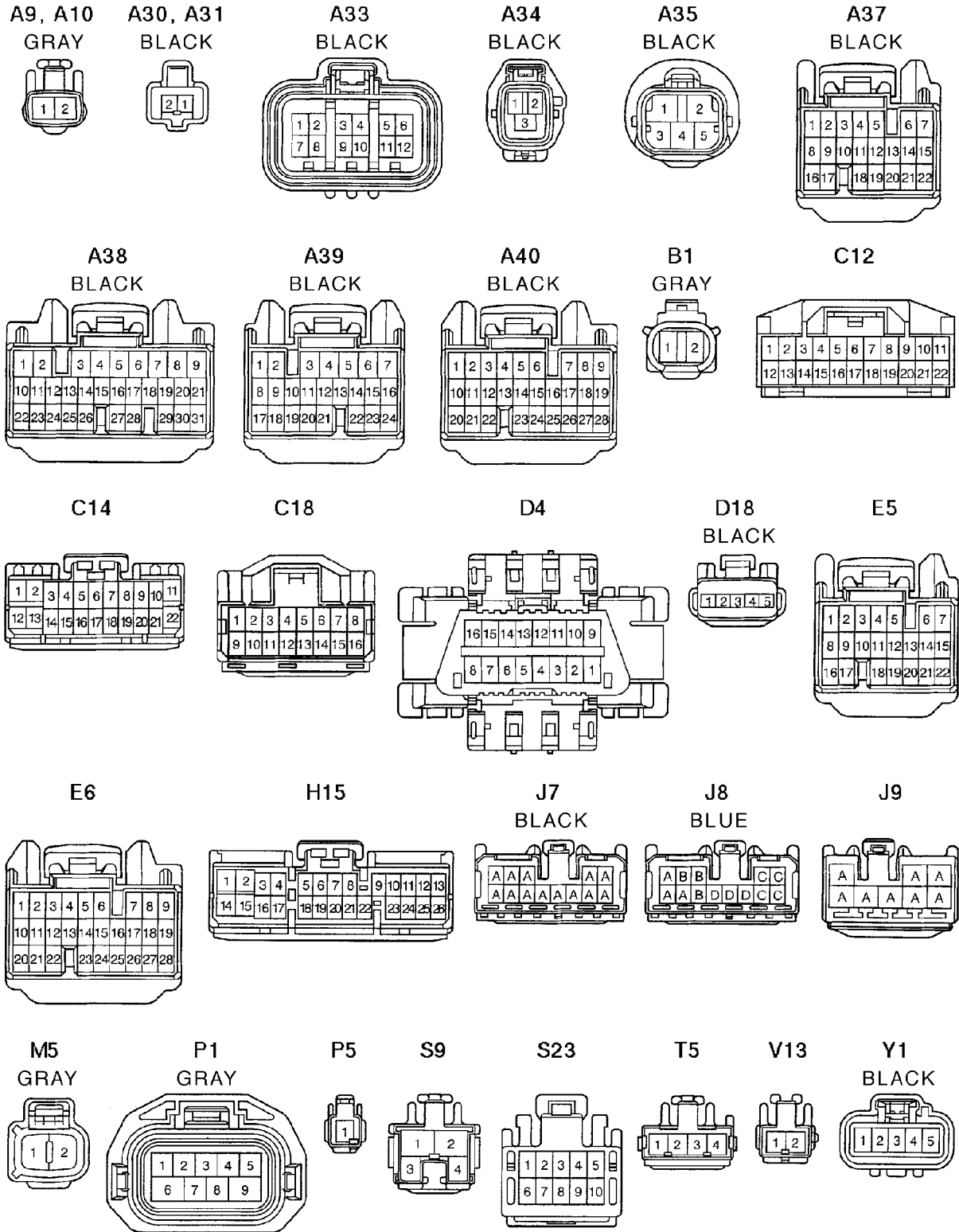

Figure TA2068-9 2001–02 RX300 connector pinouts

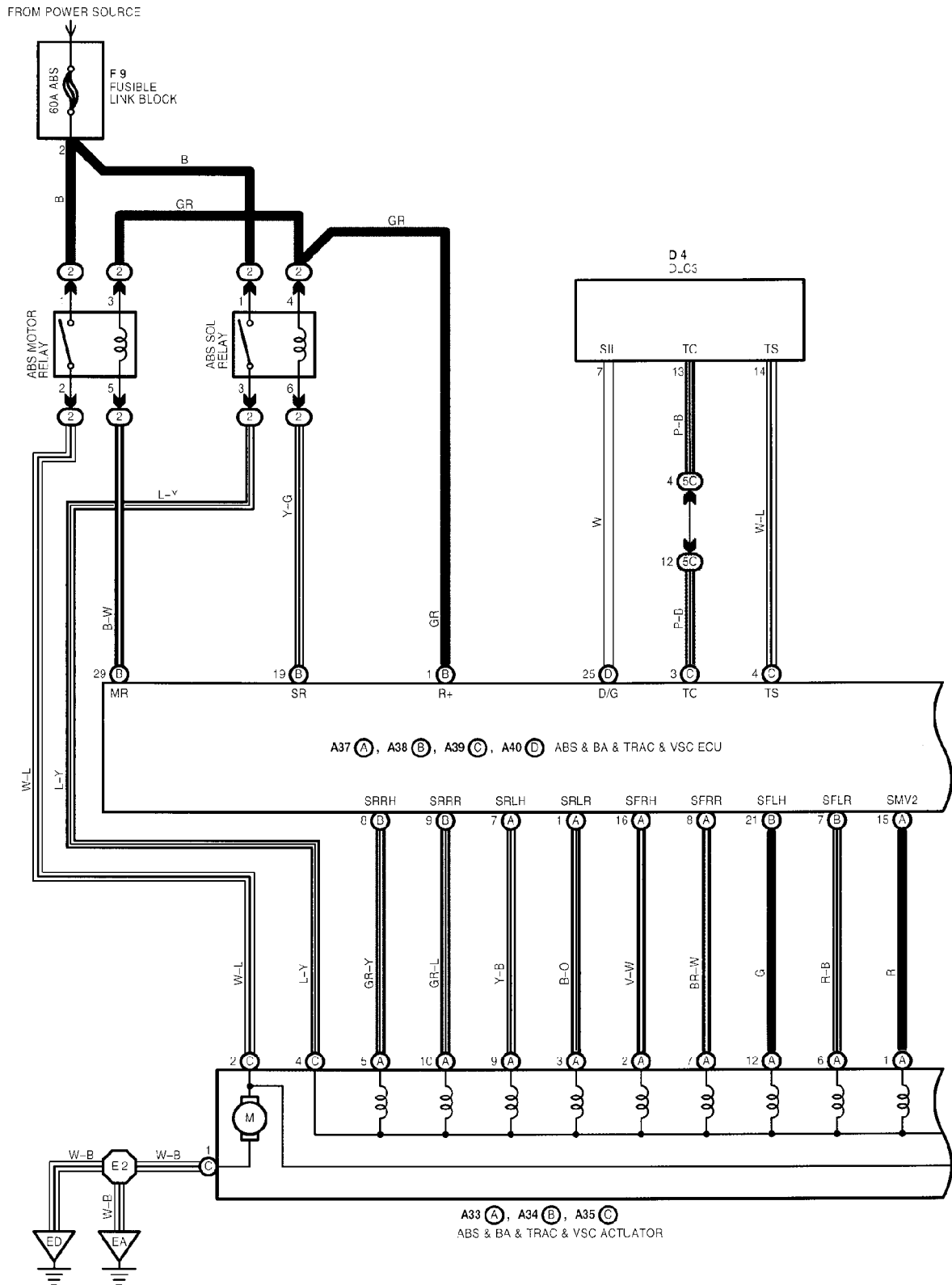

Figure TA2068-10 2001-02 RX300 wiring diagram (sheet 1 of 4)

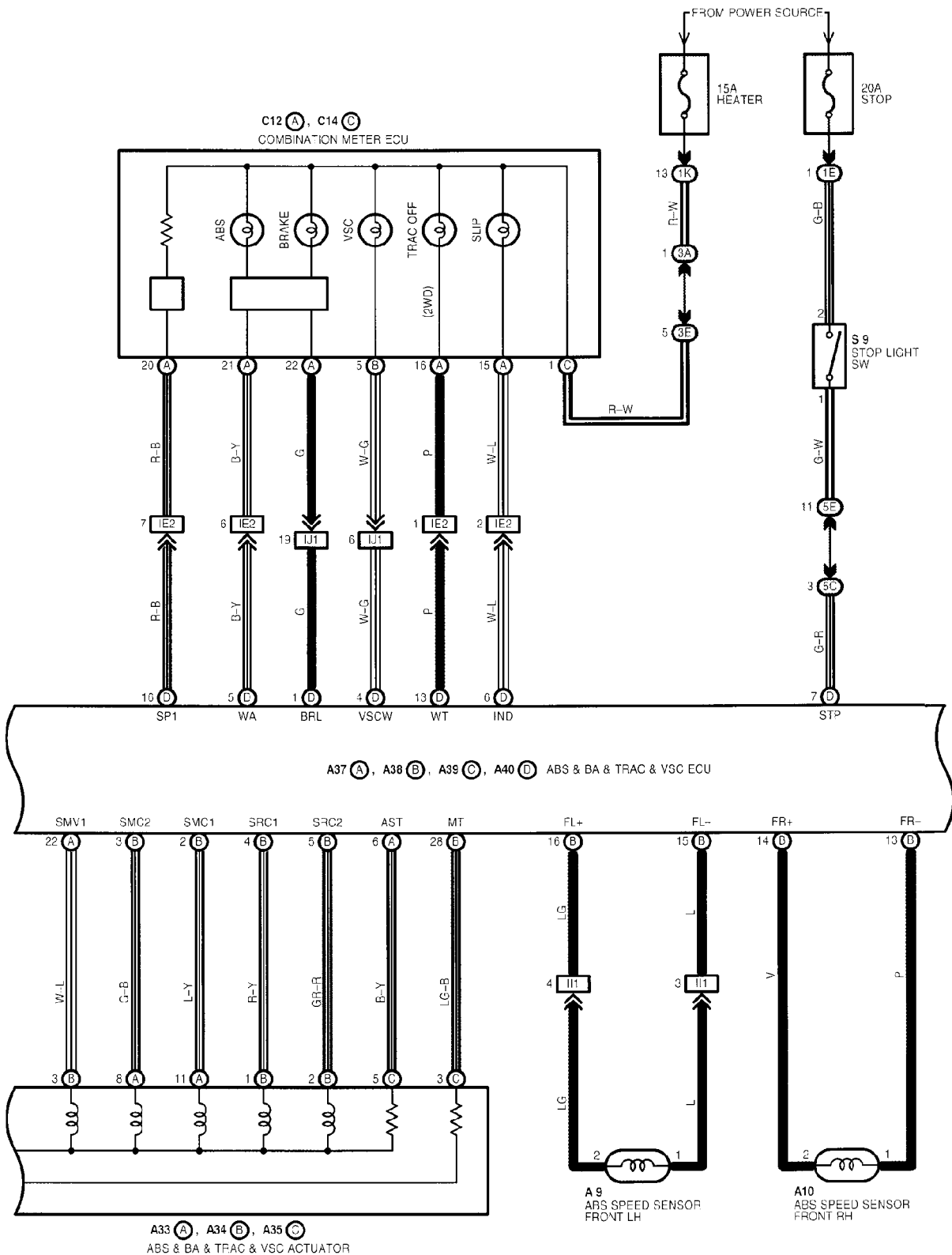

Figure TA2068-10 2001-02 RX300 wiring diagram (sheet 2 of 4)

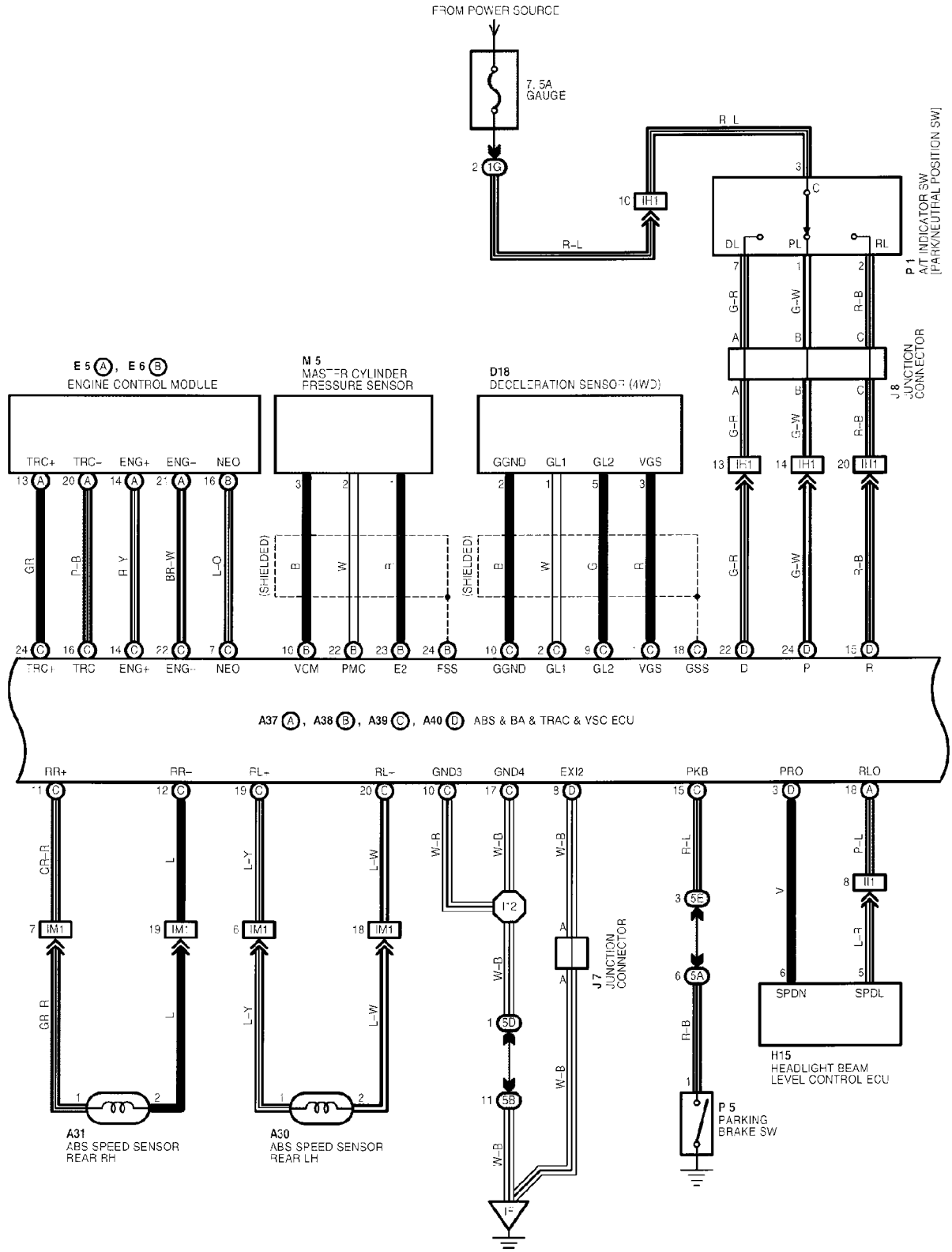

Figure TA2068-10 2001-02 RX300 wiring diagram (sheet 3 of 4)

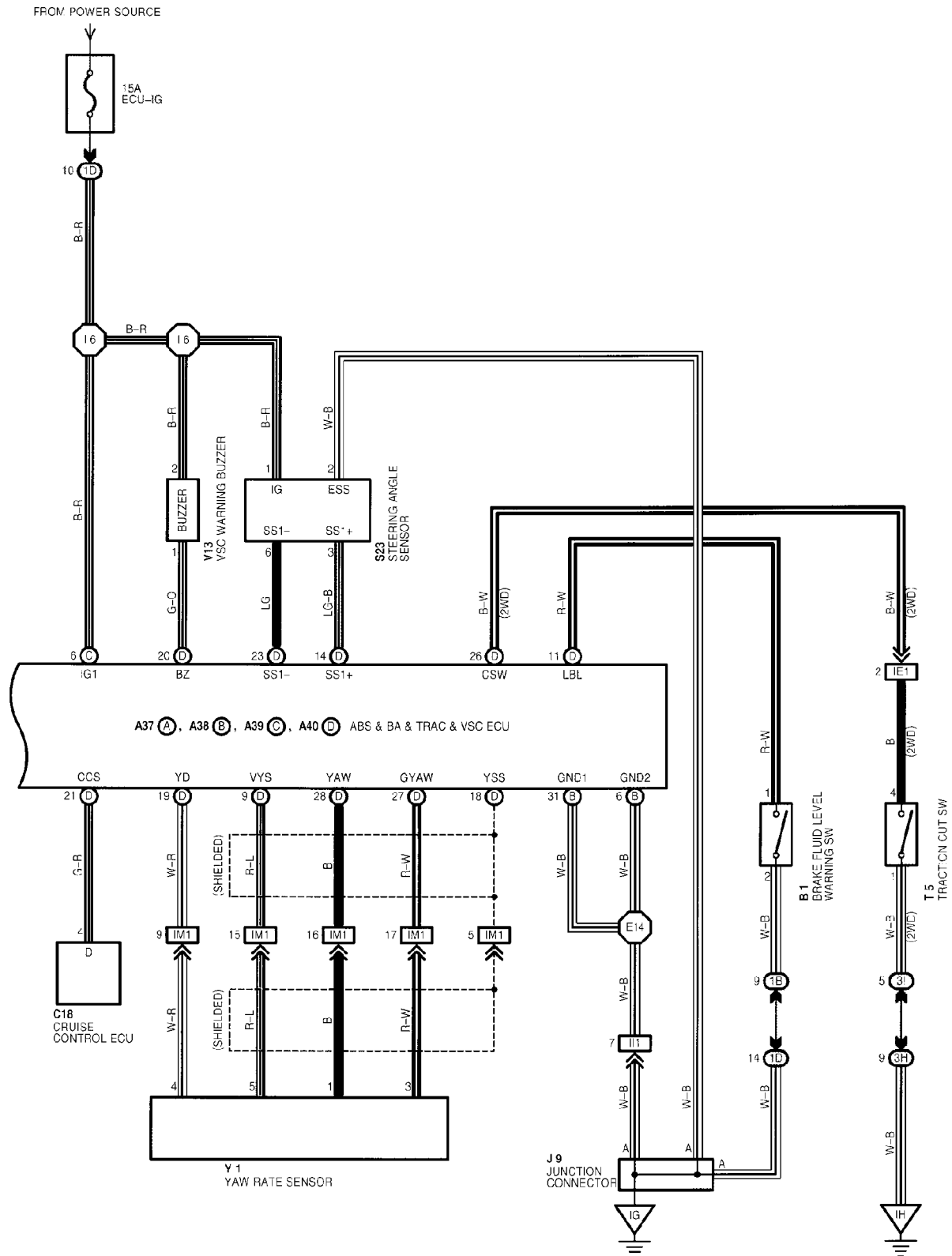

Figure TA2068-10 2001-02 RX300 wiring diagram (sheet 4 of 4)

▽ : Location of Ground Points

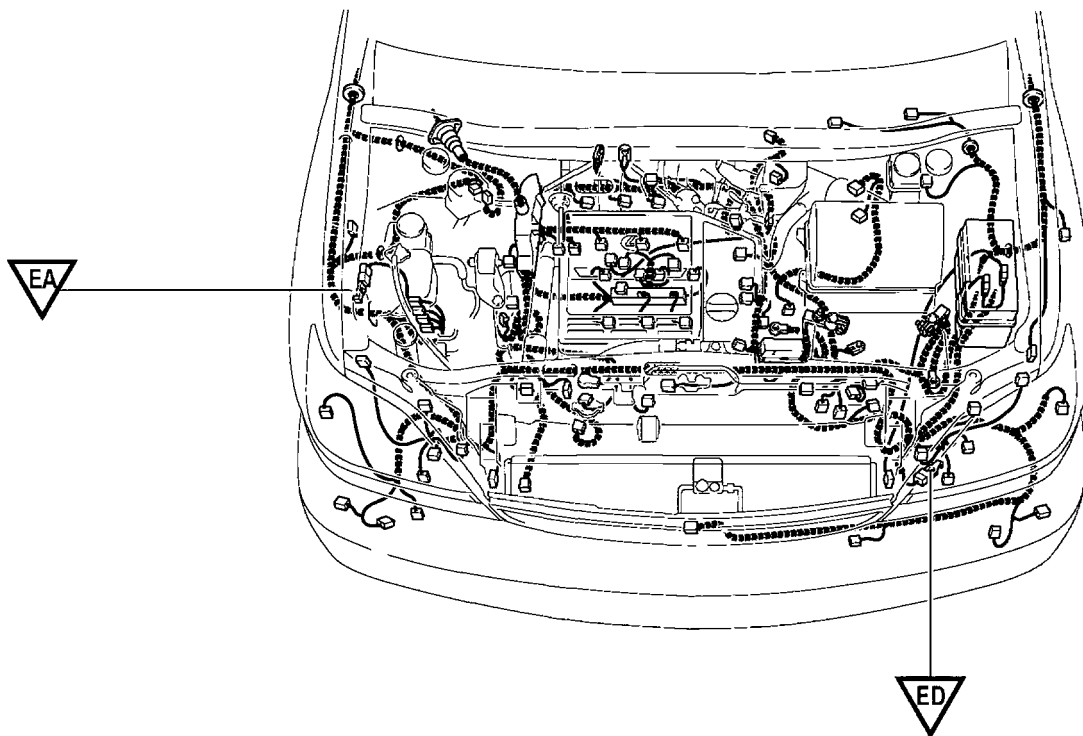

Figure TA2068-11 2001 - 2003 RX300 connector joints and grounds (sheet 1 of 2)

□ : Location of Connector Joining Wire Harness and Wire Harness
 ▽ : Location of Ground Points

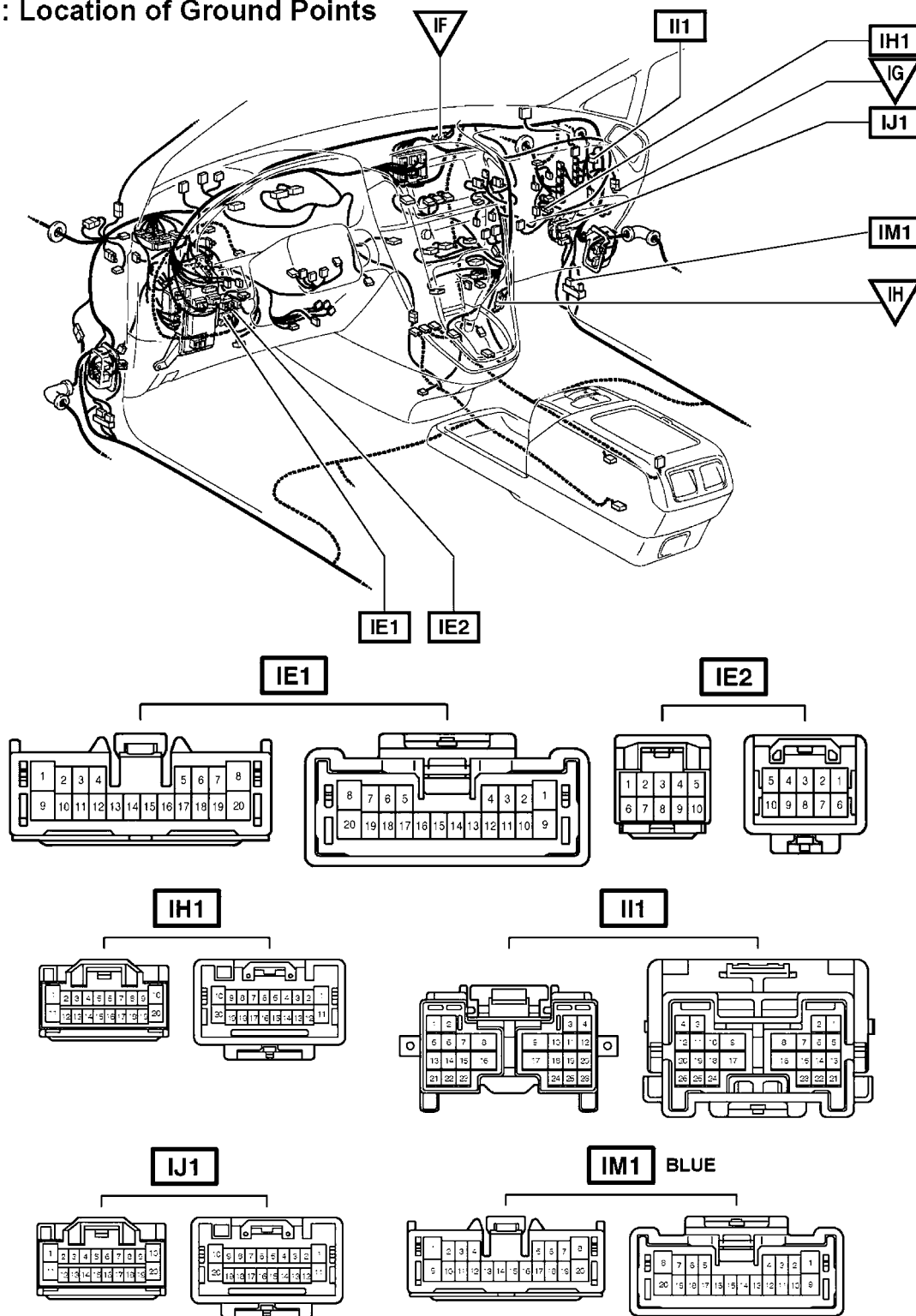

Figure TA2068-11 2001 - 2003 RX300 connector joints and grounds (sheet 2 of 2)

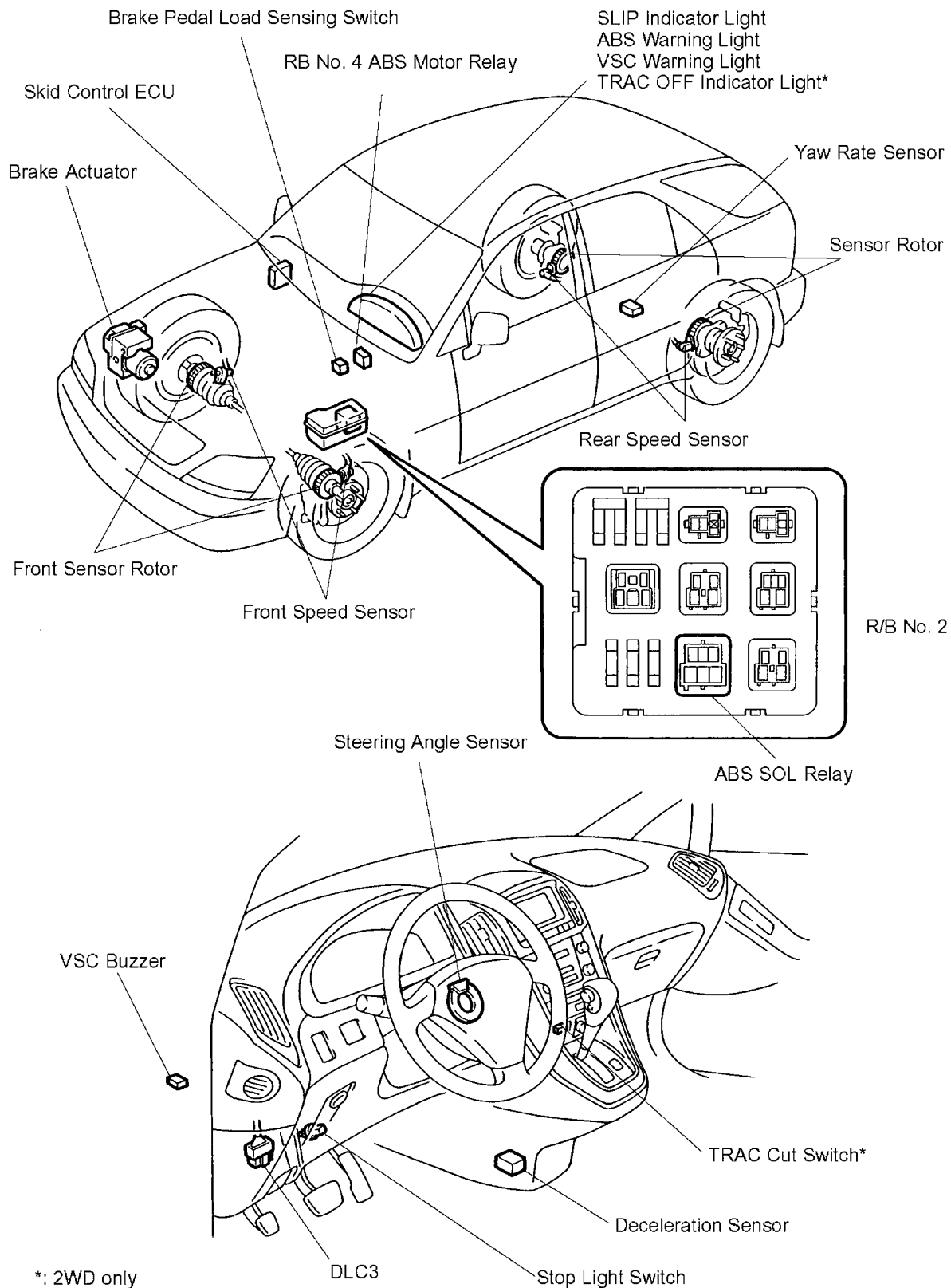

Figure TA2068-12 2003 RX300 component locations

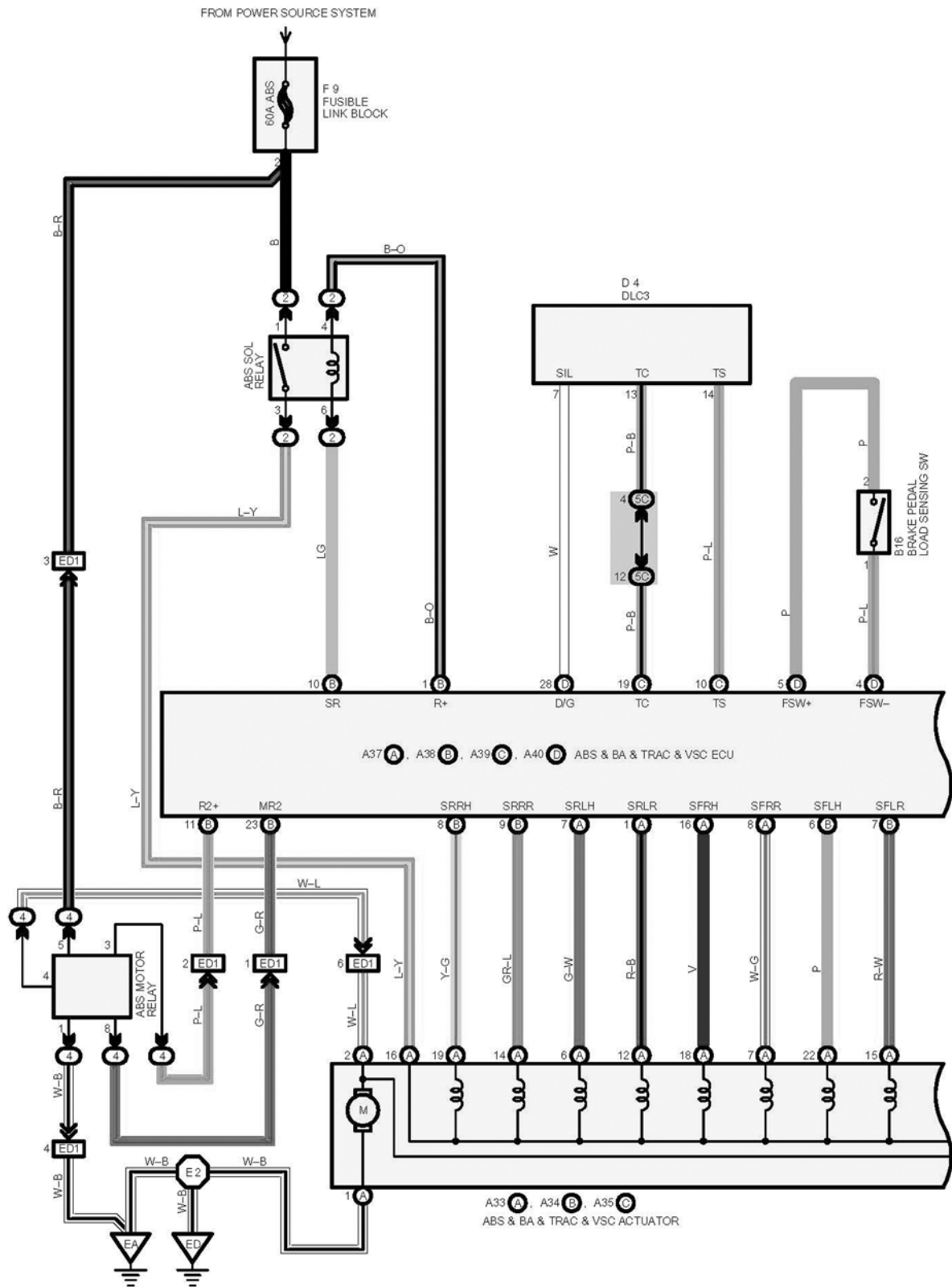

Figure TA2068-13 2003 RX300 wiring diagram (sheet 1 of 4)

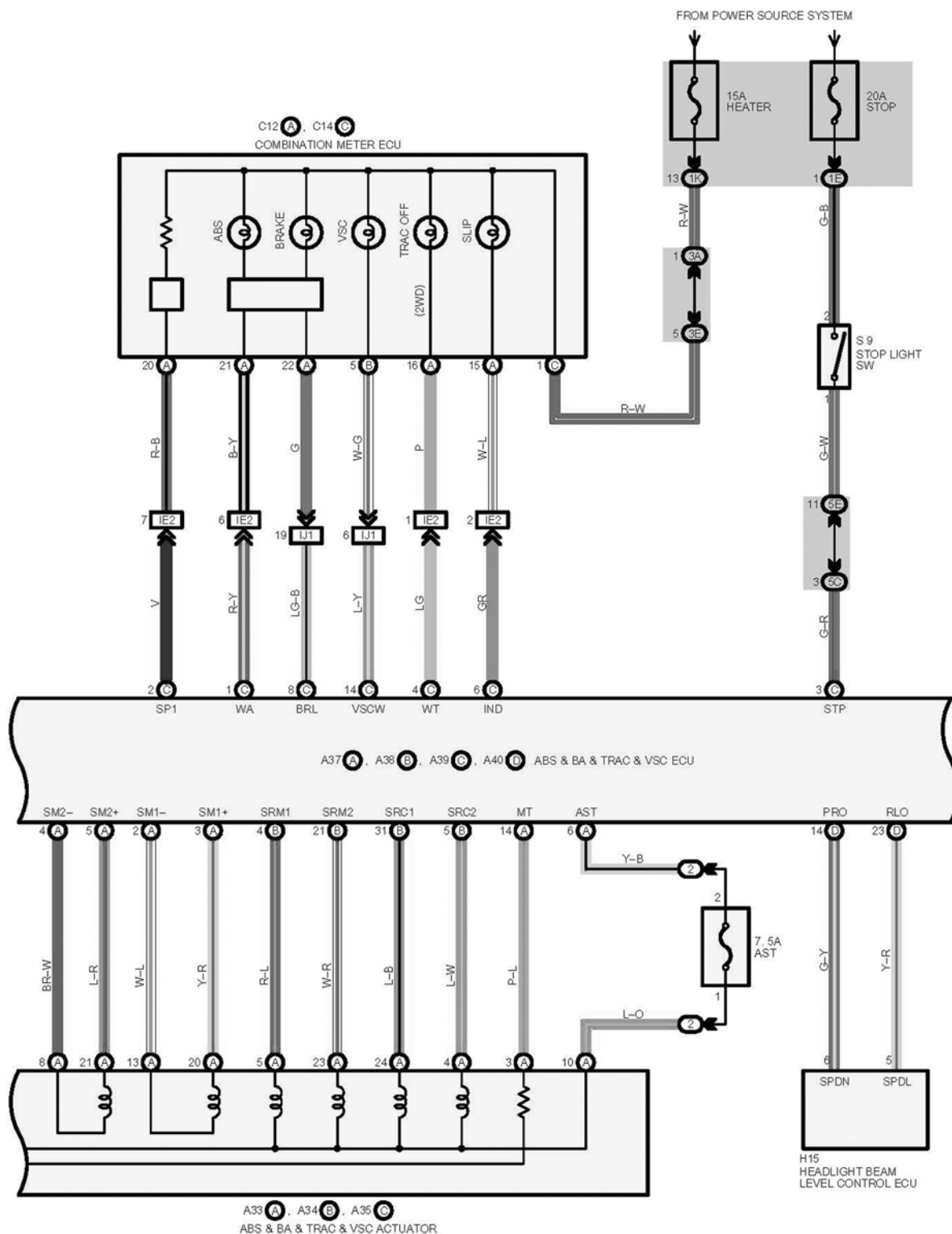

Figure TA2068-13 2003 RX300 wiring diagram (sheet 2 of 4)

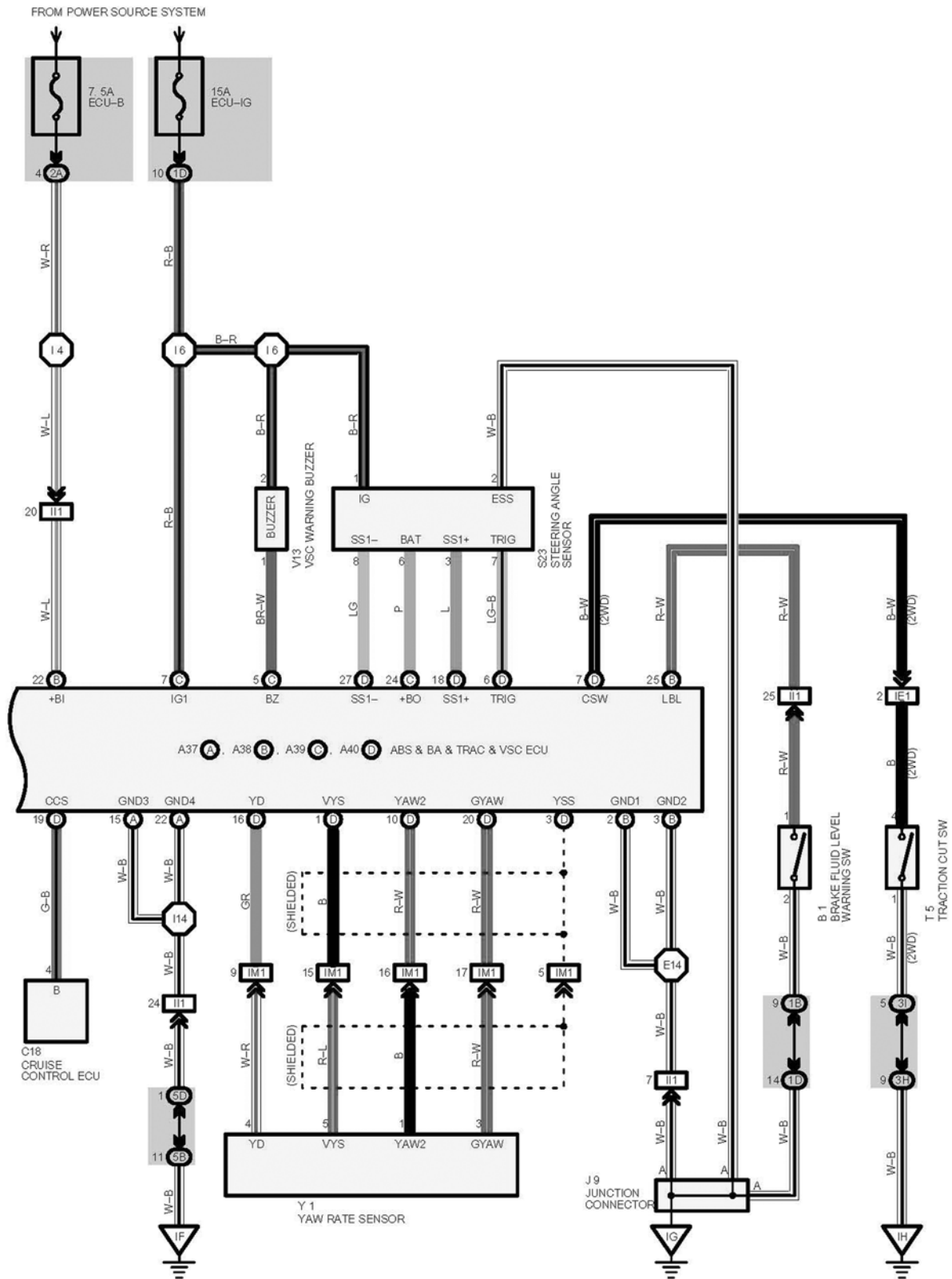

Figure TA2068-13 2003 RX300 wiring diagram (sheet 4 of 4)

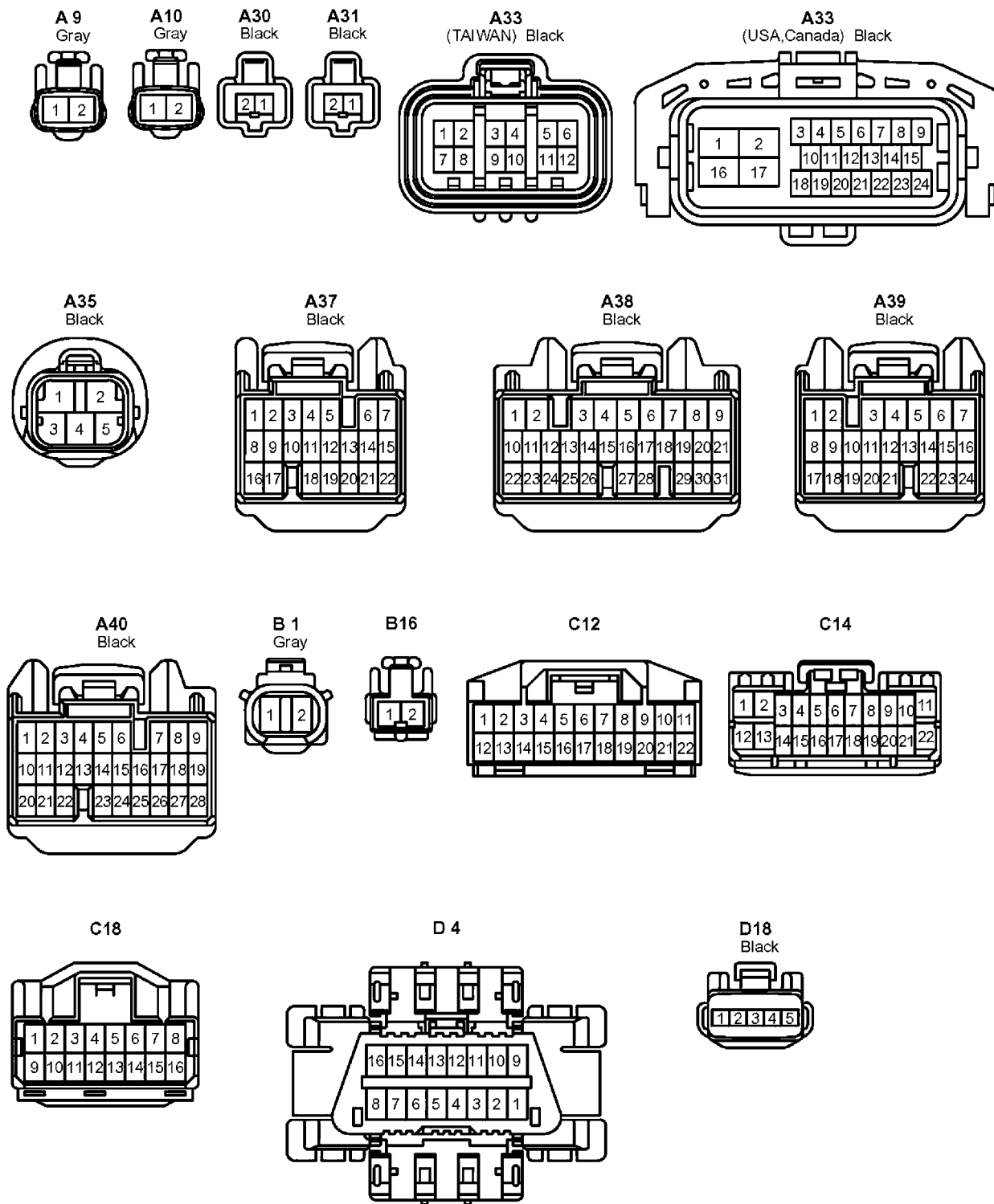

Figure TA2068-14 2003 RX300 connector pinouts (sheet 1 of 2)

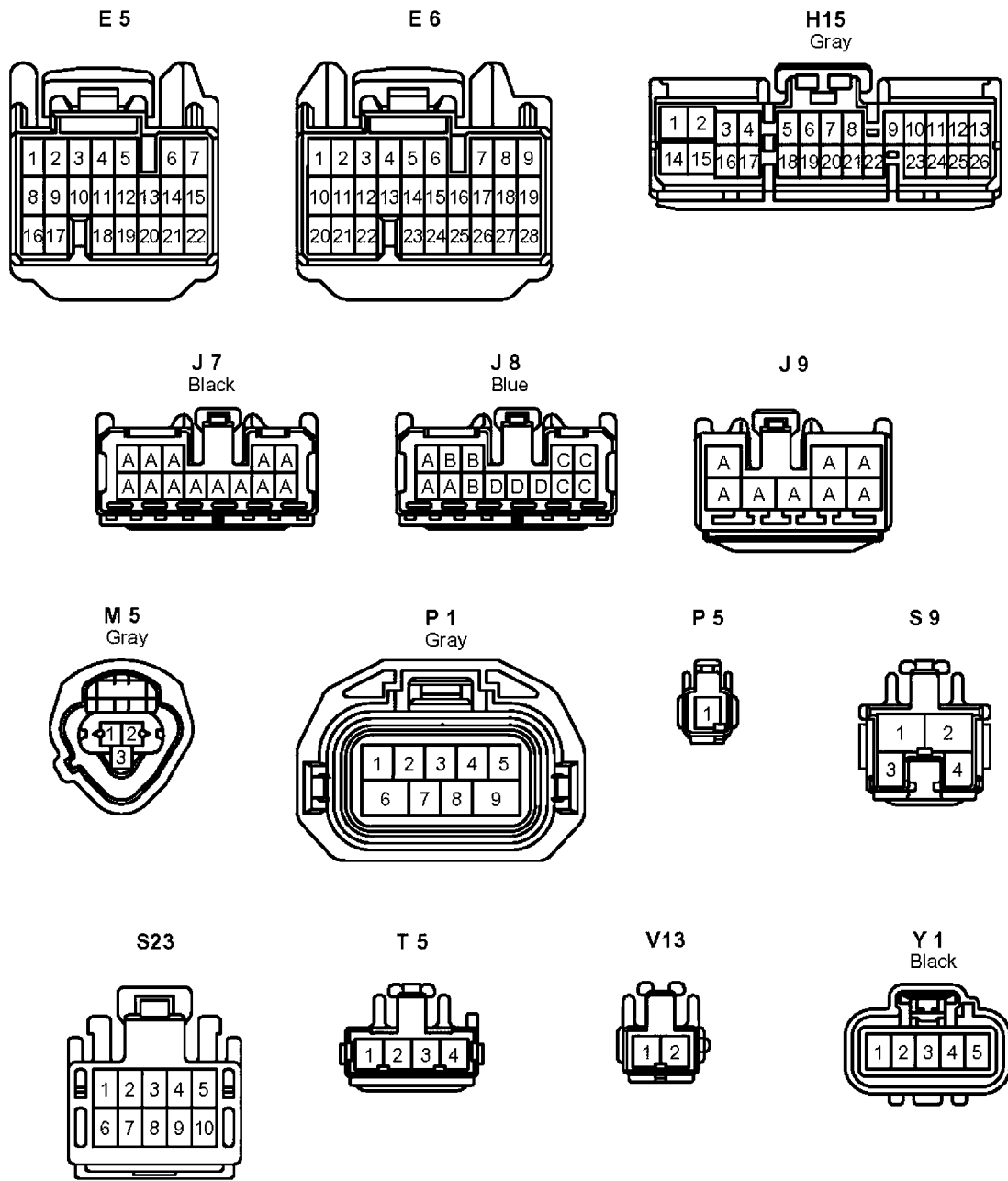

Figure TA2068-14 2003 RX300 connector pinouts (sheet 2 of 2)