

SWITCH & RELAY (0812-1203) STEERING ILLUST NO. 5 OF 7 from 200812 to 201203.. Fits: 2011 LEXUS RX350 STANDARD 3500CC 24-VALVE DOHC EFI, AUTOMATIC, ATM STEPLESS

LEXUS of SOUTH ATLANTA PARTS

[My Profile](#)

YOUR ORDER IS EMPTY: \$0.00



[CARS](#) | [SUVS AND CROSSOVERS](#) | [ALL VEHICLES](#) | [ABOUT US](#) | [TESTIMONIALS](#) | [E-MAIL US](#) | (770) 774-1604

Search Words or Part

Like 290 +1 12



HOME > LEXUS > RX350 > 3500CC 24-VALVE DOHC EFI, AUTOMATIC, ATM STEPLESS > STANDARD > 2011 > ENTERTAINMENT, AUDIO & ELECTRONICS > SWITCH & RELAY

[Continue Shopping](#)

[Show all LEXUS RX350 Entertainment, Audio & Electronics](#)
[Show all LEXUS RX350 Parts](#)
[Show all Entertainment, Audio & Electronics](#)



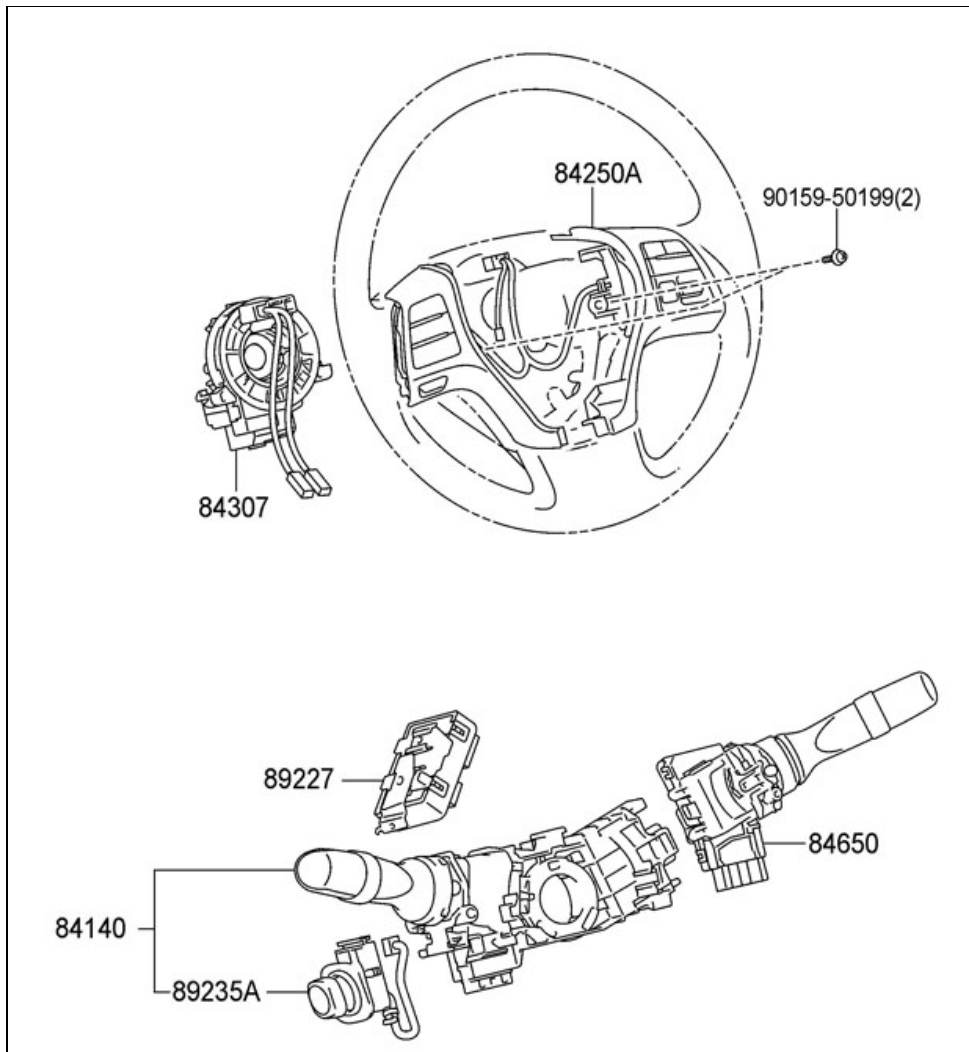

SWITCH & RELAY

(0812-1203) STEERING ILLUST NO. 5 OF 7 from 200812 to 201203.
JAPAN PRODUCT PARTS.



84A323A

Showing Parts that fit your 2011 LEXUS RX350 3500CC 24-VALVE DOHC EFI, AUTOMATIC, ATM STEPLESS STANDARD Change Vehicle

| | | | | |
|--------|--|-----------------|----------------|---|
| | SCREW, WITH WASHER | \$0.81 | 9015950199 > |  |
| 84140 | SWITCH ASSEMBLY, HEADLAMP DIMMER. SWITCH ASSY, HEADLAM | \$149.14 | 841400E030 > |  |
| 84140 | SWITCH ASSEMBLY, HEADLAMP DIMMER. SWITCH ASSY, HEADLAM; CANADA SPEC | \$149.14 | 841400E020 > |  |
| 84250A | SWITCH ASSEMBLY, STEERING PAD. BLACK.. SWITCH ASSY, STEERIN; BLACK,TRIM1#,2# | \$261.37 | 842500E060C0 > |  |

| | | | | |
|--------|--|-----------------|----------------|--|
| 84250A | SWITCH ASSEMBLY, STEERING PAD. BLACK.. SWITCH ASSY, STEERIN; KOREA SPEC&PREMIUM PACKAGE&AUDIO-CD CHANGER,12SPEAKER&EMV & NAVIGATION SYSTEM-WITH(DVD NAVIGATION),BLACK,TRIM1#,2#; KOREA SPEC&PREMIUM PACKAGE&AUDIO-CD CHANGER,12SPEAKER,BLACK,TRIM1#,2#; KOREA SPEC&PREMIUM PACKAGE&AUDIO-DVD CHANGER,15SPEAKER,MARK LEVINSON&EMV & NAVIGATION SYSTEM-WITH(DVD NAVIGATION),BLACK,TRIM1#,2#; KOREA SPEC&PREMIUM PACKAGE&AUDIO-DVD CHANGER,15SPEAKER,MARK LEVINSON,BLACK,TRIM1#,2#; KOREA SPEC&PREMIUM PACKAGE&INSIDE REAR VIEW MIRROR-AUTOMATIC ANTI-GLARE&AUDIO-CD CHANGER,12SPEAKER&EMV & NAVIGATION SYSTEM-WITH(DVD NAVIGATION),BLACK,TRIM1#,2#; KOREA SPEC&PREMIUM PACKAGE&INSIDE REAR VIEW MIRROR-AUTOMATIC ANTI-GLARE&AUDIO-DVD CHANGER,15SPEAKER,MARK LEVINSON&EMV & NAVIGATION SYSTEM-WITH(DVD NAVIGATION),BLACK,TRIM1#,2#; KOREA SPEC&ULTRAPREMIUM PACKAGE&AUDIO-CD CHANGER,12SPEAKER&EMV & NAVIGATION SYSTEM-WITH(DVD NAVIGATION),BLACK,TRIM1#,2#; KOREA SPEC&ULTRAPREMIUM PACKAGE&AUDIO-CD CHANGER,12SPEAKER,BLACK,TRIM1#,2#; KOREA SPEC&ULTRAPREMIUM PACKAGE&AUDIO-DVD CHANGER,15SPEAKER,MARK LEVINSON&EMV & NAVIGATION SYSTEM-WITH(DVD NAVIGATION),BLACK,TRIM1#,2#; KOREA SPEC&ULTRAPREMIUM PACKAGE&AUDIO-DVD CHANGER,15SPEAKER,MARK LEVINSON,BLACK,TRIM1#,2#; KOREA SPEC&ULTRAPREMIUM PACKAGE&INSIDE REAR VIEW MIRROR-AUTOMATIC ANTI-GLARE&AUDIO-CD CHANGER,12SPEAKER&EMV & NAVIGATION SYSTEM-WITH(DVD NAVIGATION),BLACK,TRIM1#,2#; KOREA SPEC&ULTRAPREMIUM PACKAGE&INSIDE REAR VIEW MIRROR-AUTOMATIC ANTI-GLARE&AUDIO-DVD CHANGER,15SPEAKER,MARK LEVINSON&EMV & NAVIGATION SYSTEM-WITH(DVD NAVIGATION),BLACK,TRIM1#,2#; ULTRAPREMIUM PACKAGE&AUDIO-CD CHANGER,SDARS,12SPEAKER&EMV & NAVIGATION SYSTEM-WITH(HDD NAVIGATION),BLACK,TRIM1#,2#; ULTRAPREMIUM PACKAGE&AUDIO-CD CHANGER,SDARS,12SPEAKER,BLACK,TRIM1#,2#; ULTRAPREMIUM PACKAGE&AUDIO-DVD CHANGER,SDARS,12SPEAKER&EMV & NAVIGATION SYSTEM-WITH(HDD NAVIGATION),BLACK,TRIM1#,2#; ULTRAPREMIUM PACKAGE&AUDIO-DVD CHANGER,SDARS,15SPEAKER,MARK LEVINSON&EMV & NAVIGATION SYSTEM-WITH(HDD NAVIGATION),BLACK,TRIM1#,2#; ULTRAPREMIUM PACKAGE&AUDIO-DVD CHANGER,SDARS,15SPEAKER,MARK LEVINSON,BLACK,TRIM1#,2#; ULTRAPREMIUM PACKAGE&INSIDE REAR VIEW MIRROR-AUTOMATIC ANTI-GLARE&AUDIO-CD CHANGER,SDARS,12SPEAKER&EMV & NAVIGATION SYSTEM-WITH(HDD NAVIGATION),BLACK,TRIM1#,2#; ULTRAPREMIUM PACKAGE&INSIDE REAR VIEW MIRROR-AUTOMATIC ANTI-GLARE&AUDIO-DVD CHANGER,SDARS,12SPEAKER&EMV & NAVIGATION SYSTEM-WITH(HDD NAVIGATION),BLACK,TRIM1#,2#; ULTRAPREMIUM PACKAGE&INSIDE REAR VIEW MIRROR-AUTOMATIC ANTI-GLARE&AUDIO-DVD CHANGER,SDARS,15SPEAKER,MARK LEVINSON&EMV & NAVIGATION SYSTEM-WITH(HDD NAVIGATION),BLACK,TRIM1#,2#; USA DEPENDANCY SPEC&ULTRAPREMIUM PACKAGE&INSIDE REAR VIEW MIRROR-AUTOMATIC ANTI-GLARE&AUDIO-CD CHANGER,12SPEAKER&EMV & NAVIGATION SYSTEM-WITH(HDD NAVIGATION),BLACK,TRIM1#,2#; USA DEPENDANCY SPEC&ULTRAPREMIUM PACKAGE&INSIDE REAR VIEW MIRROR-AUTOMATIC ANTI-GLARE&AUDIO-DVD CHANGER,15SPEAKER,MARK LEVINSON&EMV & NAVIGATION SYSTEM-WITH(HDD NAVIGATION),BLACK,TRIM1#,2# | \$250.06 | 8425048220C0 > |  |
|--------|--|-----------------|----------------|--|

84250A PACKAGE&INSIDE REAR VIEW MIRROR-AUTOMATIC ANTI-GLARE&AUDIO-DVD CHANGER,15SPEAKER,MARK LEVINSON&EMV & NAVIGATION SYSTEM-WITH(DVD NAVIGATION),DK. BROWN,TRIM0#; ULTRAPREMIUM PACKAGE&AUDIO-CD CHANGER,SDARS,12SPEAKER&EMV & NAVIGATION SYSTEM-WITH(HDD NAVIGATION),DK. BROWN,TRIM0#; ULTRAPREMIUM PACKAGE&AUDIO-CD CHANGER,SDARS,12SPEAKER,DK. BROWN,TRIM0#; ULTRAPREMIUM PACKAGE&AUDIO-DVD CHANGER,SDARS,12SPEAKER&EMV & NAVIGATION SYSTEM-WITH(HDD NAVIGATION),DK. BROWN,TRIM0#; ULTRAPREMIUM PACKAGE&AUDIO-DVD CHANGER,SDARS,12SPEAKER,DK. BROWN,TRIM0#; ULTRAPREMIUM PACKAGE&AUDIO-DVD CHANGER,SDARS,15SPEAKER,MARK LEVINSON&EMV & NAVIGATION SYSTEM-WITH(HDD NAVIGATION),DK. BROWN,TRIM0#; ULTRAPREMIUM PACKAGE&AUDIO-DVD CHANGER,SDARS,15SPEAKER,MARK LEVINSON,DK. BROWN,TRIM0#; ULTRAPREMIUM PACKAGE&INSIDE REAR VIEW MIRROR-AUTOMATIC ANTI-GLARE&AUDIO-CD CHANGER,SDARS,12SPEAKER&EMV & NAVIGATION SYSTEM-WITH(HDD NAVIGATION),DK. BROWN,TRIM0#; ULTRAPREMIUM PACKAGE&INSIDE REAR VIEW MIRROR-AUTOMATIC ANTI-GLARE&AUDIO-DVD CHANGER,SDARS,12SPEAKER&EMV & NAVIGATION SYSTEM-WITH(HDD NAVIGATION),DK. BROWN,TRIM0#; ULTRAPREMIUM PACKAGE&INSIDE REAR VIEW MIRROR-AUTOMATIC ANTI-GLARE&AUDIO-DVD CHANGER,SDARS,15SPEAKER,MARK LEVINSON&EMV & NAVIGATION SYSTEM-WITH(HDD NAVIGATION),DK. BROWN,TRIM0#; USA DEPENDANCY SPEC&ULTRAPREMIUM PACKAGE&INSIDE REAR VIEW MIRROR-AUTOMATIC ANTI-GLARE&AUDIO-CD CHANGER,12SPEAKER&EMV & NAVIGATION SYSTEM-WITH(HDD NAVIGATION),DK. BROWN,TRIM0#; USA DEPENDANCY SPEC&ULTRAPREMIUM PACKAGE&INSIDE REAR VIEW MIRROR-AUTOMATIC ANTI-GLARE&AUDIO-DVD CHANGER,15SPEAKER,MARK LEVINSON&EMV & NAVIGATION SYSTEM-WITH(HDD NAVIGATION),DK. BROWN,TRIM0#
 GGL1# RX450 H (GYL15); JAPAN PRODUCT PARTS
 RX350 (GGL15),RX450 H (GYL15); JAPAN PRODUCT PARTS

84250A SWITCH ASSEMBLY, STEERING PAD. DK. BROWN.. SWITCH ASSY, STEERIN; MEXICO SPEC&AUDIO-CD CHANGER,9SPEAKER,DK. BROWN,TRIM0#; USA DEPENDANCY SPEC&AUDIO-CD CHANGER,9SPEAKER,DK.BROWN,TRIM0#
 GGL1# GYL1#; JAPAN PRODUCT PARTS
 GGL1#; JAPAN PRODUCT PARTS

\$233.38 [8425048200E0](#) 

84250A SWITCH ASSEMBLY, STEERING PAD. DK. BROWN.. SWITCH ASSY, STEERIN; PREMIUM PACKAGE&PRECRASH SYSTEM-WITH(PRE-CRASH SEAT BELT & PRE-CRASH BRAKE ASSIST),DK. BROWN,TRIM0#; ULTRAPREMIUM PACKAGE&PRECRASH SYSTEM-WITH(PRE-CRASH SEAT BELT & PRE-CRASH BRAKE ASSIST)&AUDIO-CD CHANGER,SDARS,12SPEAKER,DK. BROWN,TRIM0#; ULTRAPREMIUM PACKAGE&PRECRASH SYSTEM-WITH(PRE-CRASH SEAT BELT & PRE-CRASH BRAKE ASSIST),DK. BROWN,TRIM0#
 GGL1# RX450 H (GYL15); JAPAN PRODUCT PARTS
 RX450 H (GYL10); JAPAN PRODUCT PARTS





\$266.73 [8425048240E0](#) 

84250A SWITCH ASSEMBLY, STEERING PAD. DK. BROWN.. SWITCH ASSY, STEERIN; ULTRAPREMIUM PACKAGE&PRECRASH SYSTEM-WITH(PRE-CRASH SEAT BELT & PRE-CRASH BRAKE ASSIST)&AUDIO-CD CHANGER,SDARS,12SPEAKER&EMV & NAVIGATION SYSTEM-WITH(HDD NAVIGATION),DK. BROWN,TRIM0#; ULTRAPREMIUM PACKAGE&PRECRASH SYSTEM-WITH(PRE-CRASH SEAT BELT & PRE-CRASH BRAKE ASSIST)&AUDIO-CD CHANGER,SDARS,12SPEAKER,DK. BROWN,TRIM0#; ULTRAPREMIUM PACKAGE&PRECRASH SYSTEM-WITH(PRE-CRASH SEAT BELT & PRE-CRASH BRAKE ASSIST)&AUDIO-DVD CHANGER,SDARS,12SPEAKER&EMV & NAVIGATION SYSTEM-WITH(HDD NAVIGATION),DK. BROWN,TRIM0#; ULTRAPREMIUM PACKAGE&PRECRASH SYSTEM-WITH(PRE-CRASH SEAT BELT & PRE-CRASH BRAKE ASSIST)&AUDIO-DVD CHANGER,SDARS,12SPEAKER,DK. BROWN,TRIM0#; ULTRAPREMIUM PACKAGE&PRECRASH SYSTEM-WITH(PRE-CRASH SEAT BELT & PRE-CRASH BRAKE ASSIST)&AUDIO-DVD CHANGER,SDARS,15SPEAKER,MARK LEVINSON&EMV & NAVIGATION SYSTEM-WITH(HDD NAVIGATION),DK. BROWN,TRIM0#; ULTRAPREMIUM PACKAGE&PRECRASH SYSTEM-WITH(PRE-CRASH SEAT BELT & PRE-CRASH BRAKE ASSIST)&AUDIO-DVD CHANGER,SDARS,15SPEAKER,MARK LEVINSON,DK. BROWN,TRIM0#; ULTRAPREMIUM PACKAGE&PRECRASH SYSTEM-WITH(PRE-CRASH SEAT BELT & PRE-CRASH BRAKE ASSIST)&INSIDE REAR VIEW MIRROR-AUTOMATIC ANTI-GLARE&AUDIO-CD CHANGER,SDARS,12SPEAKER&EMV & NAVIGATIONSYSTEM-WITH(HDD NAVIGATION),DK. BROWN,TRIM0#; ULTRAPREMIUM PACKAGE&PRECRASH SYSTEM-WITH(PRE-CRASH SEAT BELT & PRE-CRASH BRAKE ASSIST)&INSIDE REAR VIEW MIRROR-AUTOMATIC ANTI-GLARE&AUDIO-DVD CHANGER,SDARS,12SPEAKER&EMV & NAVIGATIONSYSTEM-WITH(HDD NAVIGATION),DK. BROWN,TRIM0#; ULTRAPREMIUM PACKAGE&PRECRASH SYSTEM-WITH(PRE-CRASH SEAT BELT & PRE-CRASH BRAKE ASSIST)&INSIDE REAR VIEW MIRROR-AUTOMATIC ANTI-GLARE&AUDIO-DVD CHANGER,SDARS,15SPEAKER,MARK LEVINSON&EMV & NAVIGATION SYSTEM-WITH(HDD NAVIGATION),DK. BROWN,TRIM0#; USA DEPENDANCY SPEC&ULTRAPREMIUM PACKAGE&PRECRASHSYSTEM-WITH(PRE-CRASH SEAT BELT & PRE-CRASH BRAKE ASSIST)&INSIDE REAR VIEW MIRROR-AUTOMATIC ANTI-GLARE&AUDIO-CD CHANGER,12SPEAKER&EMV& NAVIGATION SYSTEM-WITH(HDD NAVIGATION),DK. BROWN,TRIM0#; USA DEPENDANCY SPEC&ULTRAPREMIUM PACKAGE&PRECRASHSYSTEM-WITH(PRE-CRASH SEAT BELT & PRE-CRASH BRAKE ASSIST)&INSIDE REAR VIEW MIRROR-AUTOMATIC ANTI-GLARE&AUDIO-DVD CHANGER,15SPEAKER,MARK LEVINSON&EMV & NAVIGATION SYSTEM-WITH(HDD NAVIGATION),DK. BROWN,TRIM0#
 GGL1# RX450 H (GYL15); JAPAN PRODUCT PARTS

\$261.37 [8425048250E0](#) 

84250A SWITCH ASSEMBLY, STEERING PAD. DK. BROWN.. SWITCH ASSY, STEERIN; USA DEPENDANCY SPEC&PREMIUM PACKAGE&PRECRASH SYSTEM-WITH(PRE-CRASH SEAT BELT & PRE-CRASH BRAKE ASSIST)&AUDIO-CD CHANGER,9SPEAKER,DK.BROWN,TRIM0#; USA DEPENDANCY SPEC&ULTRAPREMIUM PACKAGE&PRECRASHSYSTEM-WITH(PRE-CRASH SEAT BELT & PRE-CRASH BRAKE ASSIST)&AUDIO-CD CHANGER,9SPEAKER,DK. BROWN,TRIM0#
 GGL1# RX450 H (GYL15); JAPAN PRODUCT PARTS
 RX450 H (GYL10); JAPAN PRODUCT PARTS

\$233.38 [8425048230E0](#) 

| | | | |
|--------|---|-----------------|---|
| 84307 | <p>CABLE SUB-ASSEMBLY, SPIRAL; CABLE SUB-ASSEMBLY, SPIRAL WITH SENSOR. CABLE SUB-ASSY, SPIR; APPEARANCE PACKAGE(SR5)&AUDIO-AM/FM,CD,SATELLITE,BLUETOOTH,8SPEAKER; APPEARANCE PACKAGE(SR5)&AUDIO-AVN+JBL&BACK MONITOR-WITH(AVN); APPEARANCE PACKAGE(SR5)&AUDIO-DISPLAY AUDIO&BACK MONITOR-WITH(AVN); APPEARANCE PACKAGE(SR5)&AUDIO-JBL&BACK MONITOR-WITH(IN INNER MIRROR); LIMITED PACKAGE&AUDIO-AM/FM,CD,SATELLITE,BLUETOOTH,8SPEAKER&BACK MONITOR-WITH(IN INNER MIRROR); LIMITED PACKAGE&AUDIO-AVN+JBL&BACK MONITOR-WITH(AVN); LIMITED PACKAGE&AUDIO-DISPLAY AUDIO&BACK MONITOR-WITH(AVN); LIMITED PACKAGE&AUDIO-JBL&BACK MONITOR-WITH(IN INNER MIRROR); SR5 PACKAGE&AUDIO-AM/FM,CD,SATELLITE,BLUETOOTH,8SPEAKER; SR5 PACKAGE&AUDIO-AVN+JBL&BACK MONITOR-WITH(AVN); SR5 PACKAGE&AUDIO-DISPLAY AUDIO&BACK MONITOR-WITH(AVN); SR5 PACKAGE&AUDIO-JBL&BACK MONITOR-WITH(IN INNER MIRROR); TRAIL PACKAGE&AUDIO-AM/FM,CD,SATELLITE,BLUETOOTH,8SPEAKER&BACK MONITOR-WITH(IN INNER MIRROR); TRAIL PACKAGE&AUDIO-AVN+JBL&BACK MONITOR-WITH(AVN); TRAIL PACKAGE&AUDIO-DISPLAY AUDIO&BACK MONITOR-WITH(AVN); TRAIL PACKAGE&AUDIO-JBL&BACK MONITOR-WITH(IN INNERMIRROR) GGL1#,GYL1#; JAPAN PRODUCT PARTS</p> | \$502.88 | 8430730090 >  |
| 84650 | <p>SWITCH ASSEMBLY, WINDSHIELD WIPER. SWITCH, WINDSHIELD W GGL1#,GYL1#; JAPAN PRODUCT PARTS</p> | \$155.08 | 8465248160 >  |
| 84650 | <p>SWITCH ASSEMBLY, WINDSHIELD WIPER. SWITCH, WINDSHIELD W; CANADA SPEC&INTERMITTENT WIPER-AUTO(RAIN SENSOR); INTERMITTENT WIPER-AUTO(RAIN SENSOR)</p> | \$183.38 | 846520E040 >  |
| 89227 | <p>COMPUTER, MULTIPLEX TILT & TELESCOPIC. COMPUTER, MULTIPLEX; (L) GGL1#,GYL1#; JAPAN PRODUCT PARTS</p> | \$503.06 | 892270E030 >  |
| 89235A | <p>SWITCH, TILT & TELESCOPIC. SWITCH, TILT & TELES GGL1#,GYL1#; JAPAN PRODUCT PARTS</p> | \$50.28 | 8923530120 >  |

! While every reasonable effort is made to ensure the accuracy of this data, we are not responsible for any errors or omissions contained on these pages. Please verify any information in question with a sales representative.

TECHNOLOGY POWERED BY SIMPLEPART ■ ■ ■

Copyright Lexus of South Atlanta Parts | [Policies](#)

WEB05