

Part Number: PT29A-48111-XX

Kit Contents

Item #	Quantity Reqd.	Description
1	1	Molding, LH Front Door
2	1	Molding, LH Rear Door
3	1	Molding, RH Front Door
4	1	Molding, RH Rear Door

Hardware Bag Contents

Item #	Quantity Reqd.	Description
1		
2		

Additional Items Required For Installation

Item #	Quantity Reqd.	Description
1		
2		

Conflicts

Door Edge Guards

Recommended Tools

Personal & Vehicle Protection	Notes
Safety Glasses	
Vehicle Protection	Seat & Floor Covers
Special Tools	Notes
Roller	Hard Rubber Hand Roller, 1" to 3" wide.
Installation Tools	Notes
Flexible Scale or Tape Measure	
Masking Tape	2" wide
Clean Lint-free Cloths	
Non intrusive Infrared Temp Probe/Gun	
Special Chemicals	Notes
Cleaner	3M™ Prep Solvent-70

General Applicability

Body Side Molding can be installed on all RX350 & RX450h Models starting with the 2010 MY.

Recommended Sequence of Application

Item #	Accessory
1	

*Mandatory

Vehicle Service Parts (may be required for reassembly)

Item #	Quantity Reqd.	Description

Legend

 **STOP:** Damage to the vehicle may occur. Do not proceed until process has been complied with.

 **OPERATOR SAFETY:** Use caution to avoid risk of injury.

 **CAUTION:** A process that must be carefully observed in order to reduce the risk of damage to the accessory/vehicle and to ensure a quality installation.

 **TOOLS & EQUIPMENT:** Used in Figures calls out the specific tools and equipment recommended for this process.

 **REVISION MARK:** This mark highlights a change in installation with respect to previous issue.

 **SAFETY TORQUE:** This mark indicates that torque is related to safety.

Care must be taken when installing this accessory to ensure damage does not occur to the vehicle. The installation of this accessory should follow approved guidelines to ensure a quality installation.

These guidelines can be found in the "Accessory Installation Practices" document.

This document covers such items as:

- Vehicle Protection (use of covers and blankets, cleaning chemicals, etc.).
- Safety (eye protection, rechecking torque procedure, etc.).
- Vehicle Disassembly/Reassembly (panel removal, part storage, etc.).
- Electrical Component Disassembly/Reassembly (battery disconnection, connector removal, etc.).

Please see your Toyota dealer for a copy of this document.

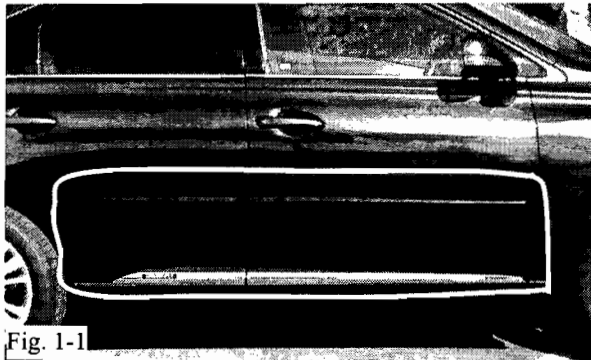

Fig. 1-1

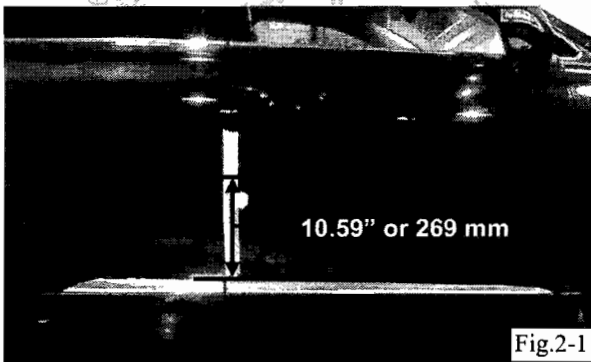

Fig.2-1

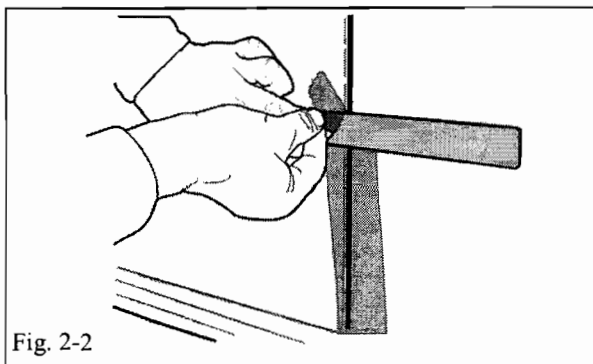





Fig. 2-2

1. Vehicle Preparation

-  (a) Before working on the vehicle, protect the seats and carpets with covers.
 -  (b) The work area, Body Side Moldings, and vehicle door surface temperatures must be at least 60°F.
 - (c) Saturate a clean lint-free cloth with 3M™ Prep Solvent-70 and clean the areas of each door as shown in Fig. 1-1.
-  **NOTE:** When cleaning with 3M™ Prep Solvent-70, follow the manufacturer's directions. Do not allow cleaner to air dry.
- (d) Wipe the cleaned surfaces with a clean, dry, lint-free cloth.

-  **NOTE:** Once cleaned do not contaminate this surface by touching it with your bare hands.

2. Alignment Tape Application

- (a) Place a vertical piece of tape approximately 12" long at the joint between the Front Door and the Rear Door as shown in Fig. 2-1.
- (b) Mark the tape 10.59" (269 mm) up from the top edge of the chrome plastic trim at the bottom of the doors and metal door panels as shown in Fig. 2-1. Using a straight edge, tear the vertical tape along a horizontal line at the upper mark as shown in Fig. 2-2.

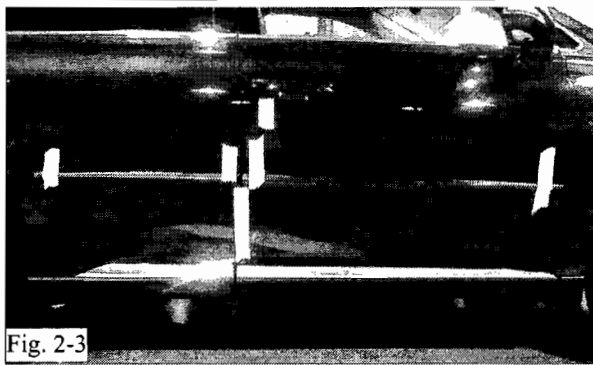

Fig. 2-3

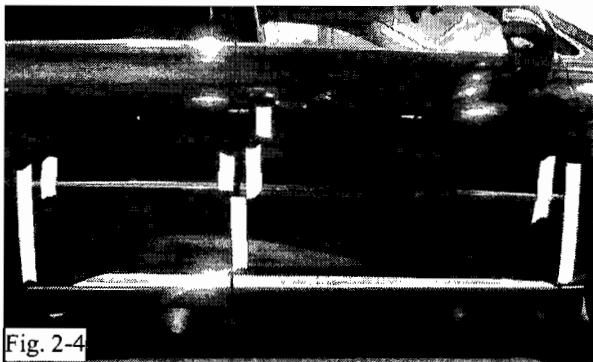

Fig. 2-4

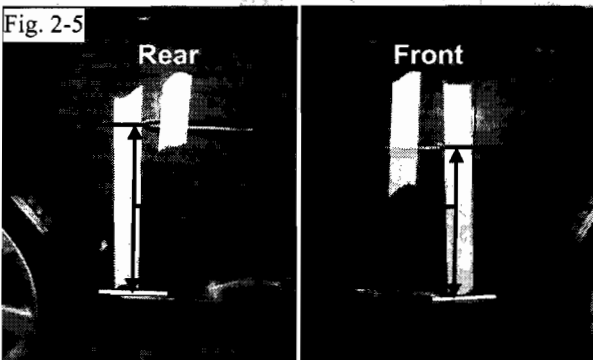
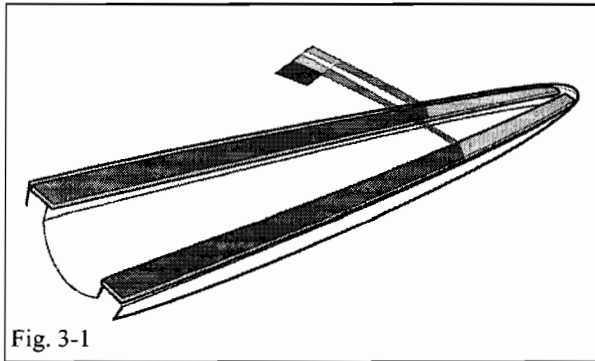

Fig. 2-5



- (c) Using masking tape, temporarily tape the front and rear moldings in place so that they are approximately parallel to the bottom of the doors as shown in Fig. 2-3. Each of the 4 moldings are identified as to the correct position on the vehicle. The bottoms of moldings should line up vertically with the top surface of the tape at the joint between the doors.
- (d) Place a vertical piece of tape at the extreme ends of the moldings as shown in Fig. 2-4.
- (e) Mark the front door piece of tape $Y = 12.00''$ (305 mm) up from the top of the plastic trim at the bottom of the fender and metal door panel and rear door piece of tape $X = 13.43''$ (341 mm) as shown in Fig. 2-5.
- (f) Readjust the height of the front and rear molding tips to line up with the marks on the vertical pieces of tape while making sure the center ends align with the top edge of the center vertical piece of tape. Once everything is in place, sight down the moldings from one end to the other, to ensure that they run in a straight line.



3. Body Side Molding Installation.

- ⚠ (a) Start with the RH front door molding. Each of the 4 moldings are identified as to the correct position on the vehicle. While carefully holding the Molding by its edges, pull the plastic tape at the end of the part to remove the orange release line from the black acrylic foam tape strips. (Fig. 3-1)

STOP NOTE: Once the release liner is removed from the Molding, the surface of the foam tape must not be touched!

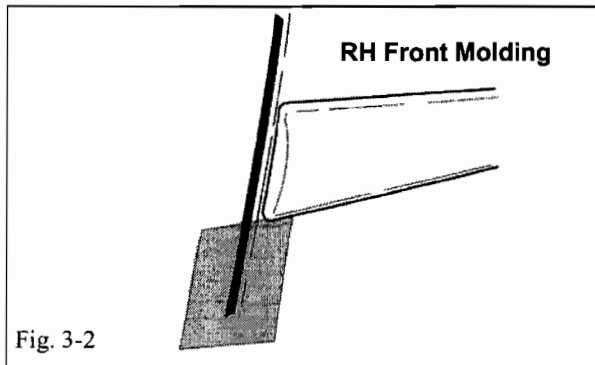

- ⚠ (b) Hold the Molding about 1/2" from the surface of the front door and align the rear edge with the rear edge of the front door as shown in Fig. 3-2 & Fig. 3-3. The bottom edge of the molding is aligned vertically at the rear with the top edge of the vertical tape strip, while the center of the front tip end is aligned with the mark on the vertical piece of tape. Once the Molding is properly aligned, press it to the door surface starting at the rear and working toward the front with a rolling motion keeping the front tip aligned with the tape mark. Do not allow both ends to contact and stick to the door before the center contacts.

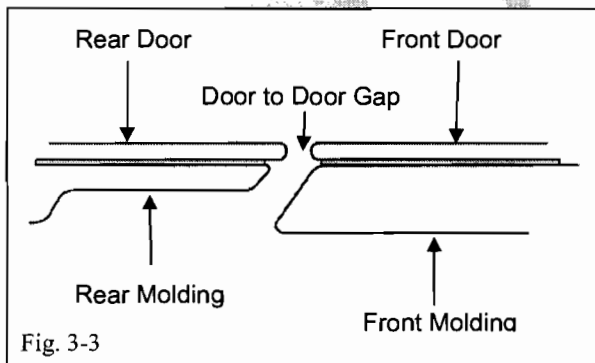

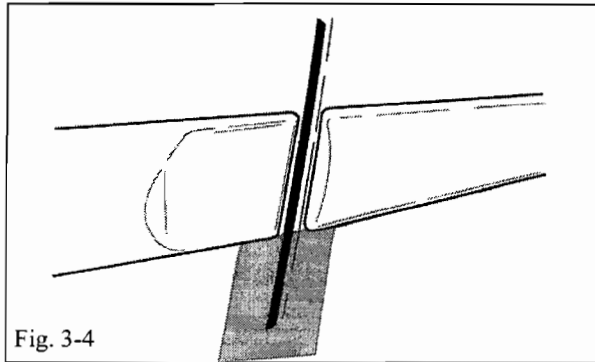

Fig. 3-4

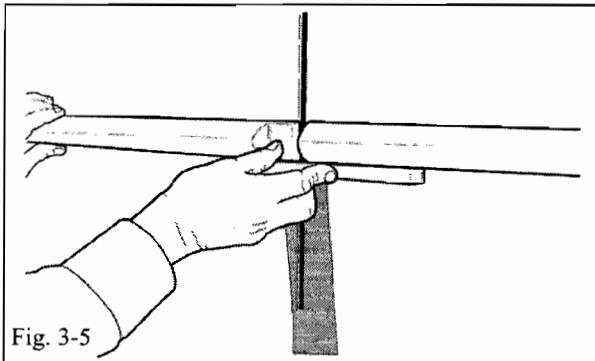

Fig. 3-5

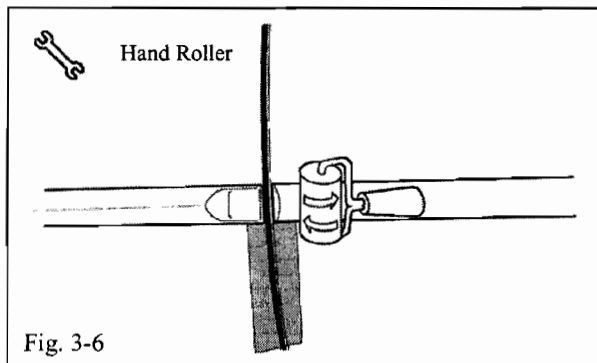

Fig. 3-6

- (c) Repeat steps 3-a and 3-b for the RH rear door molding as shown in Fig. 3-3 and Fig. 3-4.

⚠ NOTE: A good way to ensure that where the rear and front molding meet between the doors align vertically is to hold a plastic straight edge against the bottom of the front molding and use it as a guide for the rear molding as shown in Fig. 3-5.

- ⚠** (d) Using the hand roller, roll around the perimeter of the parts with a firm pressure to ensure complete adhesion of the acrylic foam tape to the door surfaces. (Fig. 3-6)
- (e) Remove and discard the vertical tape strips.
- (f) Repeat the entire installation procedure for the other side of the vehicle.

