

Part Number: PK389-13P00-TP

Kit Contents

Item #	Quantity Reqd.	Description
1	1	Front Passenger Side Mudguard
2	1	Front Driver Side Mudguard
3	1	Rear Passenger Side Mudguard
4	1	Rear Driver Side Mudguard
5	1	Hardware Bag (Front)
6	1	Hardware Bag (Rear)

Hardware Bag Contents

Item #	Qty Reqd.	Description
Front (1 Bag)		
1	6	M6 x 19mm Screw
2	6	M6 Spring Clip
Rear (1 Bag)		
1	6	M6 x 19mm Screw
2	6	M6 Spring Clip

Additional Items Required For Installation

Item #	Quantity Reqd.	Description
1		
2		
3		

Conflicts

--

Recommended Tools

Personal & Vehicle Protection	Notes
None	
Special Tools	Notes
90° Tool (Optional)	For PPO Option
Installation Tools	Notes
Screwdriver	Phillips #2 / Flathead
Socket Driver	10mm Socket
Drill w/ Bit	6mm (1/4") / 8mm (5/16")
Clean Cloth/Rag	
Special Chemicals	Notes
Cleaner	Soap & Water

General Applicability

All models.

Recommended Sequence of Application

Item #	Accessory
1	Running Boards
2	Mudguards
3	

*Mandatory

Vehicle Service Parts (may be required for reassembly)

Item #	Quantity Reqd.	Description
1		
2		
3		

Legend

 **STOP:** Damage to the vehicle may occur. Do not proceed until process has been complied with.

 **OPERATOR SAFETY:** Use caution to avoid risk of injury.

 **CAUTION:** A process that must be carefully observed in order to reduce the risk of damage to the accessory/vehicle and to ensure a quality installation.

 **TOOLS & EQUIPMENT:** Used in Figures calls out the specific tools and equipment recommended for this process.

 **REVISION MARK:** This mark highlights a change in installation with respect to previous issue.

 **SAFETY TORQUE:** This mark indicates that torque is related to safety.

 **REGULATORY MARK:** This mark indicates the component is related to regulatory compliance

Care must be taken when installing this accessory to ensure damage does not occur to the vehicle. The installation of this accessory should follow approved guidelines to ensure a quality installation.

These guidelines can be found in the “Toyota and Scion Accessory Installation Practices” or “Lexus Accessory Installation Practices” document.



This document covers such items as:

- Installation Instructions
- Safety
- Vehicle Protection
- Vehicle Disassembly/Reassembly
- Electrical Component Disassembly/Reassembly
- Use of Special Chemicals
- Temperature
- Torque Recheck
- Window Label Installation
- TPMS Check

Please refer to TIS for a copy of this document. Care must be taken when installing this accessory to ensure damage does not occur to the vehicle. The installation of this accessory should follow approved guidelines to ensure a quality installation.

These guidelines can be found in the "Accessory Installation Practices" document.

PRECAUTIONS FOR INSTALLATION:

- Contents indicated by  and  in this manual must be carefully followed during the installation. If they are result. Always carry out the installation as instructed.
- When the vehicle parts are removed, keep all tapping screws, bolts and nuts organized so that the re-assembly will proceed correctly.
- Do NOT remove vehicle parts except for those that are specified in the manual.
- Verify all kit contents and only use parts provided unless otherwise specified.

NOTE: Pictures depicted in this Installation Manual may not reflect the current model and model year vehicle.

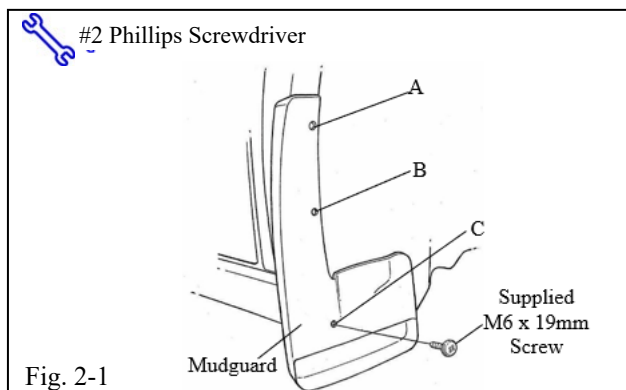
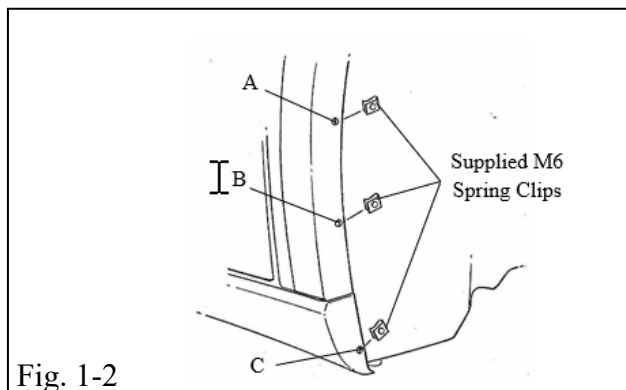
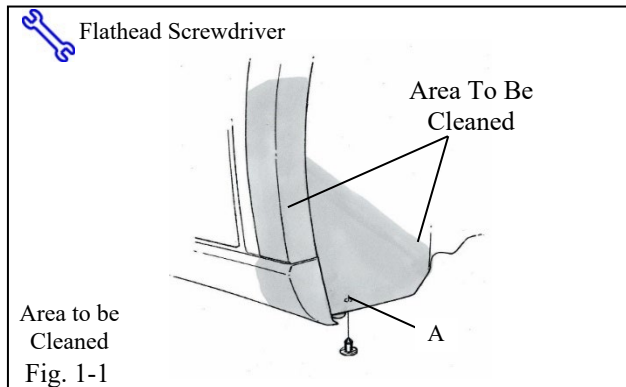

1. Clean Front Mounting Area, Hardware Removal and Install.

- a. Clean and de-grease front body where mudguard is to be located with clean cloth and soap/water. (Fig. 1-1)
- b. Turning the front wheels will allow for additional clearance during installation.
- c. Remove existing lower bottom push pin in location A. Do Not Discard. (Fig. 1-1)

- d. Pull liner out partially and install supplied M5 spring clips (medium) over metal panel hole locations A, B, and C with turned up edge on inside of panel, then reposition liner. (Fig 1-2)

2. Install Front Mudguard and Drilling.

- a. Mount mudguard on body panel and install supplied M6 x 19mm screw in location C while holding part up and into body panel then tighten. (Fig. 2-1)
- b. Install supplied screw M6 x19mm in location B while holding part tight to body panel and tighten. (Fig. 2-2)

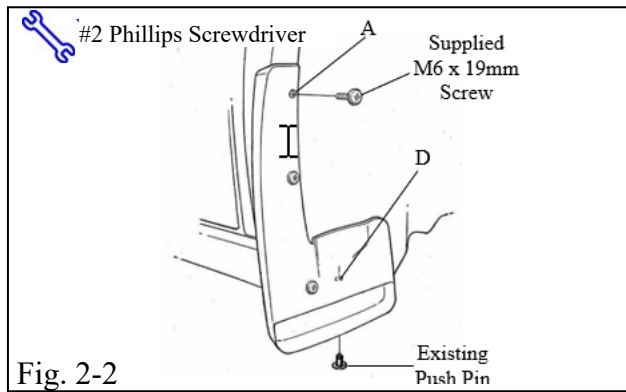

- c. While holding top of mudguard tight to panel install supplied M6 x 19mm screw in location A and tighten. (Fig. 3-3)
- d. While holding lower mudguard tight to panel reinstall existing lower bottom push pin in location D. (Fig. 3-3)
- e. Repeat procedure for other side of vehicle.

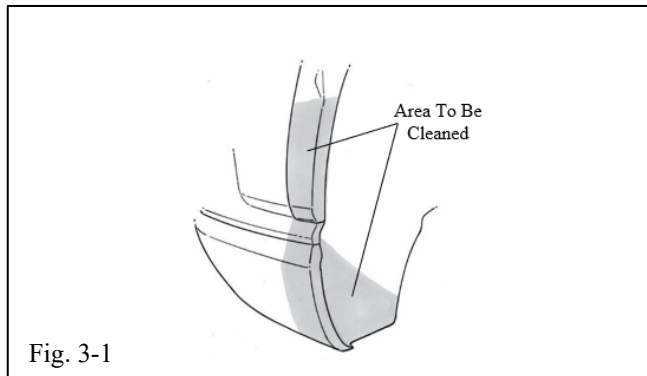

3. Clean Rear Mounting Area, Hardware Removal/Install, and Drilling

- a. Clean and degrease rear body where mudguard is to be located with a clean cloth and soap/water. (Fig. 3-1)

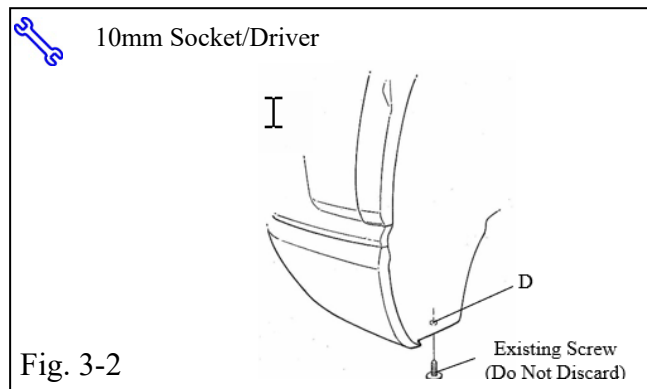

- + b. Remove rear tire and follow owner's manual procedure. *(Not Applicable to PPO)* ||

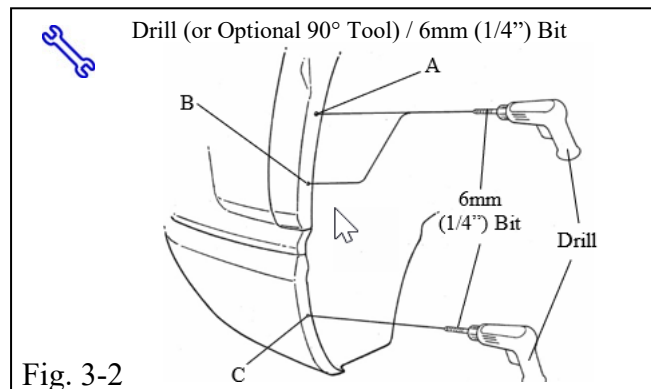

- c. Remove existing lower bottom screw location D. Do Not Discard. (Fig 3-2)
- d. Drill panel at dimple locations A, B and C with 6mm (1/4") drill bit. (Fig 3-2)

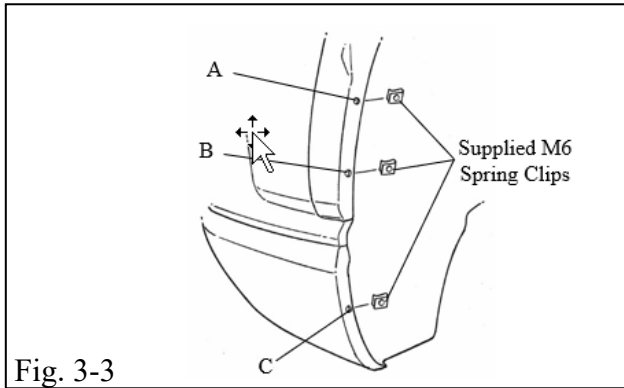

Fig. 3-3

- e. Install supplied M5 spring clips (small) centered over panel drilled holes with turned up edge on inside of panel at locations A and B. (Fig. 3-3)

4. Install Rear Mudguard and Drilling

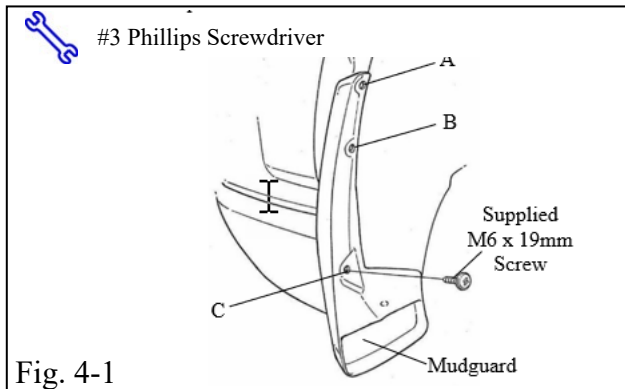

Fig. 4-1

- a. Mount mudguard while holding up and into panel install supplied M6 x 19mm screw in location C and tighten. (Fig. 4-1)

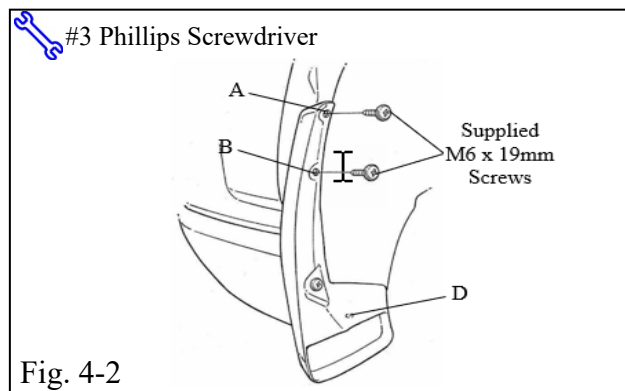
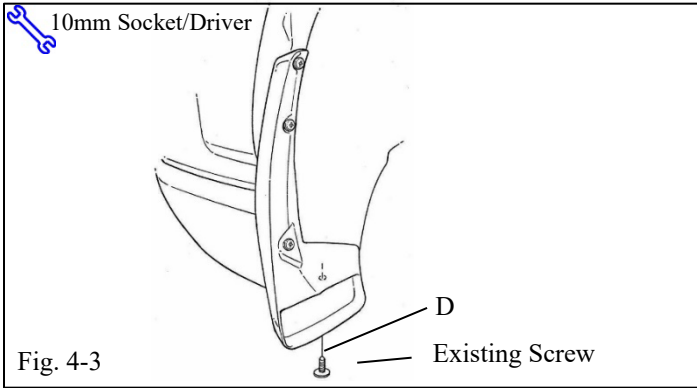

Fig. 4-2

- b. While holding mudguard up and into panel install supplied M6 x 19mm screw in location B and tighten. (Fig. 4-2)
- c. While holding top of mudguard into panel install supplied M6 x 19mm screw in location A and tighten. (Fig. 4-2)



- a. Reinstall existing lower bottom screw in location D while holding tight to lower panel. (Fig. 4-3)
- +** b. Reinstall tire and follow owner's manual procedure.
- c. Repeat procedure for other side of vehicle.

Checklist - these points **MUST** be checked to ensure a quality installation.

<u>Check:</u>	<u>Look For:</u>
<p><u>Accessory Function Checks</u></p> <ul style="list-style-type: none"><input type="checkbox"/> Gaps between the mudguards and body.<input type="checkbox"/><input type="checkbox"/><input type="checkbox"/>	<p>Excessive gaps greater than 1.0 mm.</p>
<p><u>Vehicle Function Checks</u></p> <ul style="list-style-type: none"><input type="checkbox"/><input type="checkbox"/>	
<p><u>Vehicle Appearance Check</u></p> <ul style="list-style-type: none"><input type="checkbox"/> After accessory installation and removal of protective cover(s), perform a visual inspection.	<p>Ensure no damage (including scuffs and scratches) was caused during the installation process.</p>