

BRAKE FLUID BLEEDING

BRQJC-03

HINT:

- If any work is done on the brake system or if air in the brake lines is suspected, bleed the air from the system.
- When bleeding, keep the amount of the fluid within the line of reservoir between Min. and Max.

NOTICE:

- **Do not let brake fluid remain on painted surfaces. Wash it off immediately.**
- **With the reservoir cap removed, when depressing the brake pedal, the fluid will spray.**

1. FILL RESERVOIR WITH BRAKE FLUID

Fluid: SAE J1703 or FMVSS NO. 116 DOT3

2. IN CASE OF USING LEXUS HAND-HHELD TESTER: BLEED HYDRAULIC BRAKE BOOSTER

HINT:

If the hydraulic brake booster has been disassembled, disconnect the brake line from the hydraulic brake booster or if the reservoir becomes empty, bleed the hydraulic brake booster.

- Turn the ignition switch OFF, depress the brake pedal more than 40 times.
- Turn the ignition switch ON, check that the pump stops after approx. 30 to 40 seconds.

NOTICE:

When the pump does not stop, repeat step (a) and (b) again.

- With the ignition switch remained ON, depress the brake pedal more than 20 times.
- Observe the procedure in step 4 and bleed the right and left front brake caliper.
- Holding the brake pedal depressed, bleed the right and left rear brake caliper.

HINT:

It is not necessary to depress the pedal continuously, as brake fluid flows out by first depressing.

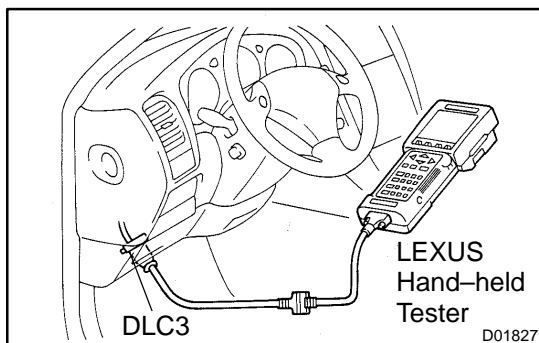

(f) Connect LEXUS hand-held tester.

- Turn the ignition switch OFF, connect the LEXUS hand-held tester to DLC3.
- Turn the ignition switch ON, and select "AIR BLEEDING" on the LEXUS hand-held tester.

HINT:

Please refer to the LEXUS hand-held tester operator's manual for further details.

- (g) Bleed right front brake line.
 - (1) Select "FR LINE" on the LEXUS hand-held tester.
 - (2) With "FR LINE" turned ON with the LEXUS hand-held tester, depress the brake pedal and hold it to bleed the right front brake caliper.
 - (3) Repeat step (2) until there are no more air bubbles in the fluid.
- (h) Bleed left front brake line.
 - (1) Select "FL LINE" on the LEXUS hand-held tester.
 - (2) With "FL LINE" turned ON with the LEXUS hand-held tester, depress the brake pedal and hold it to bleed the left front brake caliper.
 - (3) Repeat step (2) until there are no more air bubbles in the fluid.
- (i) Bleed rear brake line.
 - (1) Select "RR LINE" on the LEXUS hand-held tester.
 - (2) With "RR LINE" turned ON with the LEXUS hand-held tester, bleed the left and right rear brake caliper.
- (j) Disconnect the LEXUS hand-held tester from DLC3.
- (k) Clear the DTC (See page [DI-412](#)).

3. IN CASE OF USING ABS ACTUATOR CHECKER (SST):

BLEED HYDRAULIC BRAKE BOOSTER

HINT:

If the hydraulic brake booster has been disassembled, disconnect the brake line from the hydraulic brake booster or if the reservoir becomes empty, bleed the hydraulic brake booster.

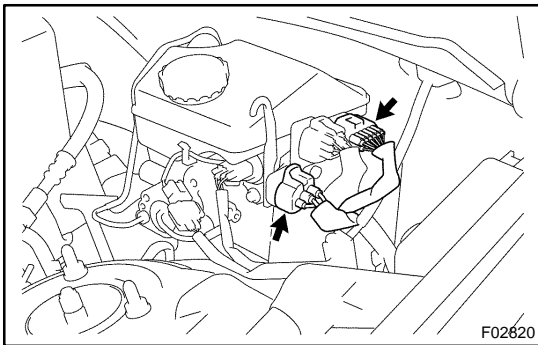

- (a) Disconnect the 2 connectors from the hydraulic brake booster.

- (b) Connect the actuator checker (SST) to the hydraulic brake booster side wire harness via the sub-wire harness S (SST), as shown in the chart below.
SST 09990-00150, 09990-00480

HINT:

Connect the connector with the label of "AIR BLEED" attached to the connector of actuator checker.

- (c) Connect the red cable of the actuator checker to the battery positive (+) terminal and the black cable to the negative (-) terminal.

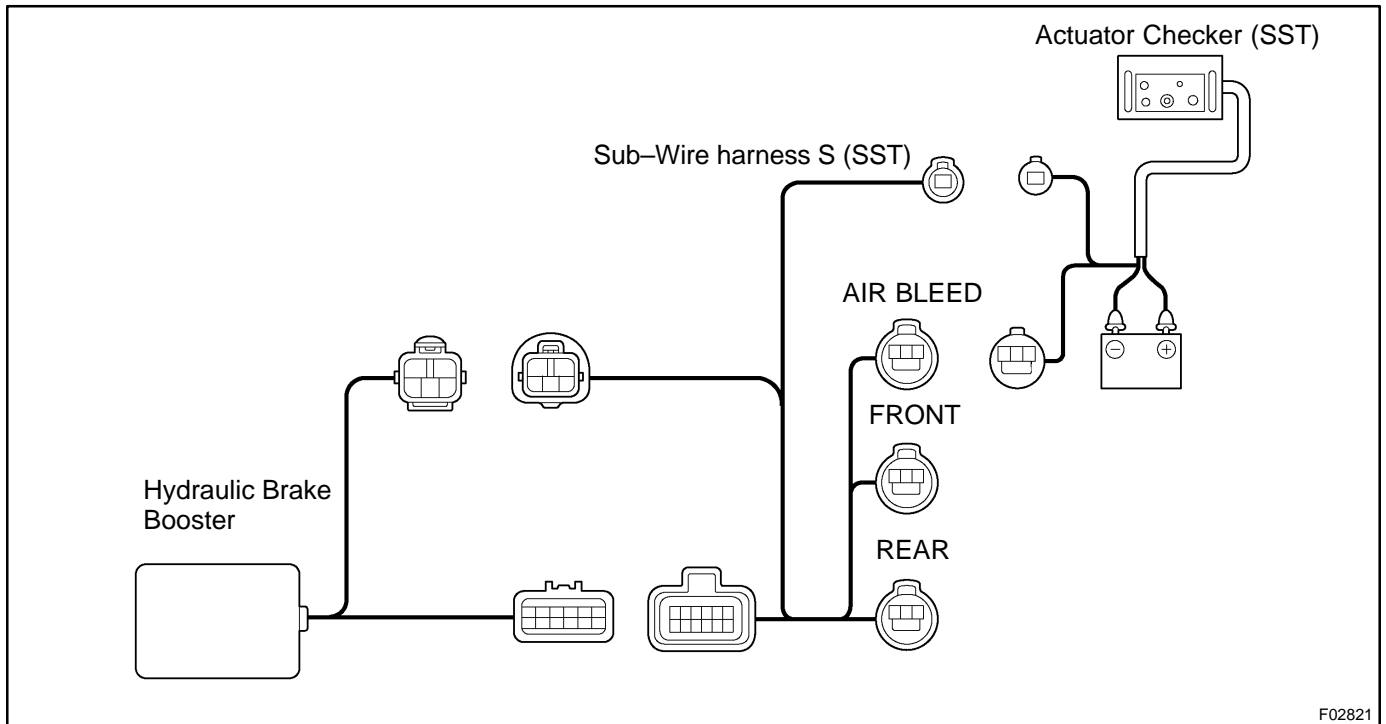

F02821

- (d) Turn the ignition switch OFF, depress the brake pedal more than 40 times.
(e) Turn the ignition switch ON, check that the pump stops after approx. 30 to 40 seconds.

NOTICE:

When the pump does not stop, repeat step (d) and (e) again.

- (f) With the ignition switch remained ON, depress the brake pedal more than 20 times.
(g) Observe the procedure in step 4 and bleed the right and left front wheel caliper.
(h) Holding the brake pedal depressed, bleed the right and left rear wheel caliper.

HINT:

It is not necessary to depress the pedal continuously, as brake fluid flows out by first depressing.

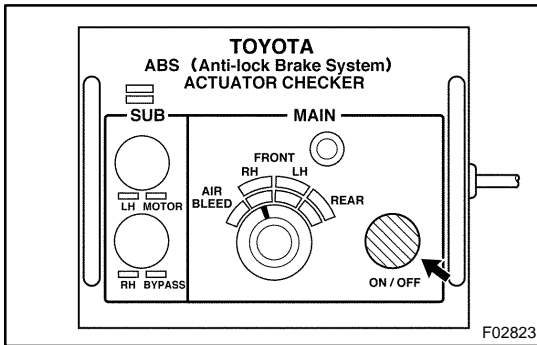

- (i) Bleed right front brake line.
- (1) Turn the selector switch of the actuator checker to the "FRONT RH" position.
 - (2) Push and hold in MAIN push switch, depress the brake pedal and hold it to bleed the right front brake caliper.

NOTICE:

Do not keep the MAIN switch pushed in for more than 10 seconds. When operating it continuously, set the interval of more than 20 seconds.

- (3) Repeat step (2) until there are no more air bubbles in the fluid.

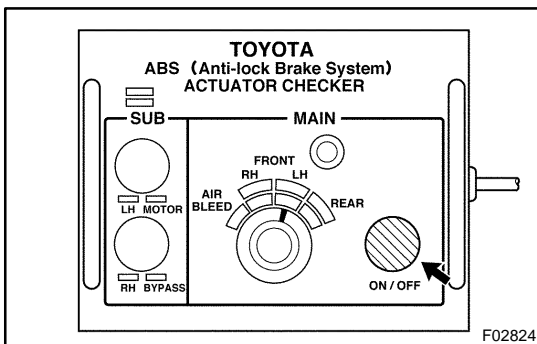

- (j) Bleed left front brake line.
- (1) Turn the selector switch of the actuator checker to the "FRONT LH" position.
 - (2) Push and hold in the MAIN push switch, depress the brake pedal and hold it to bleed the left front brake caliper.

NOTICE:

Do not keep the MAIN switch pushed in for more than 10 seconds. When operating it continuously, set the interval of more than 20 seconds.

- (3) Repeat step (2) until there are no more air bubbles in the fluid.

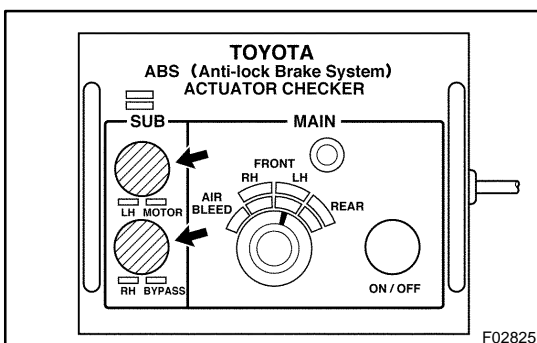

- (k) Bleed right rear brake line.
- (1) Push and hold in the "SUB LH" and "SUB RH" switches, bleed the right rear brake caliper.

NOTICE:

Do not keep the MAIN switch pushed in for more than 10 seconds. When operating it continuously, set the interval of more than 20 seconds.

- (2) Repeat step (1) until there are no more air bubbles in the fluid.

- (l) Observe the procedure in step (k) and bleed left rear brake line.
- (m) Disconnect the actuator checker (SST) and sub-wire harness (SST) from the actuator.
SST 09990-00150, 09990-00480
- (n) Connect the 2 connectors to the hydraulic brake booster.
- (o) Clear the DTC (See page [DI-412](#)).

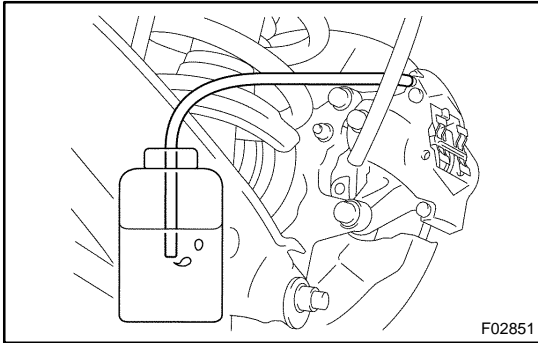

4. BLEED BRAKE LINE

- (a) Connect the vinyl tube to the brake caliper.
- (b) Depress the brake pedal several times, then loosen the bleeder plug with the pedal held down.
- (c) At the point when fluid stops coming out, tighten the bleeder plug, then release the brake pedal.
- (d) Repeat (b) and (c) until all the air in the fluid has been bled out.
- (e) Repeat the above procedure to bleed the brake line for each wheel.

Torque: 11 N·m (110 kgf·cm, 8 ft·lbf)

5. CHECK FLUID LEVEL IN RESERVOIR

- (a) With the ignition switch OFF, depress the brake pedal more than 40 times.
- (b) Remove the reservoir cap. Add brake fluid up to the "MAX" line.

Fluid: SAE J1703 or FMVSS NO. 116 DOT3